

# SSG5000X Series RF Signal Generator

## Programming Guide

EN01D



SIGLENT TECHNOLOGIES CO.,LTD



# Contents

<b>1</b>	<b>Programming Overview</b>	<b>1</b>
1.1	Build communication via VISA	1
1.1.1	Install NI-VISA	1
1.1.2	Connect the instrument to computer	4
1.2	Remote Control	6
1.2.1	User-defined Programming	6
1.2.2	Send SCPI via NI-MAX	6
1.2.3	Send SCPI over Telnet	11
1.2.4	Send SCPI over Socket	12
<b>2</b>	<b>Introduction to the SCPI Language</b>	<b>13</b>
2.1	Command Format	13
2.2	Symbol Instruction	13
2.3	Parameter Type	14
2.4	Command Abbreviation	15
<b>3</b>	<b>Commands</b>	<b>16</b>
3.1	IEEE 488.2 Common Commands	16
3.1.1	Identification Query (*IDN?)	16
3.1.2	Reset (*RST)	16
3.1.3	Clear Status (*CLS)	16
3.1.4	Standard Event Status Enable (*ESE)	16
3.1.5	Standard Event Status Register Query (*ESR?)	17
3.1.6	Operation Complete Query (*OPC)	17
3.1.7	Service Request Enable (*SRE)	17
3.1.8	Status Byte Query (*STB?)	18
3.1.9	Wait-to-Continue (*WAI)	18
3.1.10	Self Test Query (*TST?)	18
3.2	SYSTem Commands	19
3.2.1	System Configuration	19
3.2.2	System Reset/Preset	25
3.3	OUTPut Commands	27
3.3.1	RF Output (:OUTPut[:STATe])	27
3.3.2	Analog Modulation State (:OUTPut:MODulation[:STATe])	27
3.4	SOURce Commands	28
3.4.1	RF Output ([:SOURce]:OUTPut)	28
3.4.2	Software Trigger([:SOURce]:*TRG)	28

---

3.4.3	Frequency.....	28
3.4.4	Level .....	30
3.4.5	Sweep.....	37
3.4.6	Sensor .....	47
3.4.7	Analog Modulation.....	48
3.4.8	Pulse Modulation.....	58
3.4.9	LF Source .....	67
3.4.10	LF Sweep .....	70
3.4.11	System Preset .....	74
3.4.12	IQ Modulation .....	74
3.4.13	Custom .....	74
3.4.14	ARB .....	82
3.4.15	I/Q Control .....	106
3.4.16	IoT .....	112
3.4.17	Multitone .....	142
3.4.18	AWGN.....	144
3.5	SENSE Commands .....	145
3.5.1	Power Sensor.....	145
3.6	MEMoryCommands.....	153
3.6.1	ARB .....	153
<b>4</b>	<b>Programming Examples .....</b>	<b>155</b>
4.1	VISA Examples .....	155
4.1.1	VC++ Example .....	155
4.1.2	VB Example.....	162
4.1.3	MATLAB Example .....	167
4.1.4	LabVIEW Example .....	169
4.2	Socket Examples.....	171
4.2.1	Python Example .....	171

# 1 Programming Overview

The SSG5000X Series Signal Generator supports USB, LAN and USB-GPIB interfaces. Through these interfaces, combined with NI-VISA and corresponding programming language, users can use the command set based on SCPI (Standard Commands for Programmable Instruments) to remotely program and control the instrument, and interact with other programmable instruments that support the SCPI command set.

Through the LAN interface, VXI-11, Sockets, and Telnet protocols can be used to communicate with the instrument.

This chapter describes how to establish communication between the signal generator and the computer, and how to remotely control the signal generator.

## 1.1 Build communication via VISA

### 1.1.1 Install NI-VISA

Before programming, please make sure that you have properly installed the latest version of National Instruments NI-VISA Software.

NI-VISA is a communication library for communication between computers and devices. NI software has two valid VISA installation packages: full version and run-time engine version (Run-Time Engine). The runtime engine version provides NI device drivers such as USB-TMC, VXI and GPIB, etc. It is mainly used for remote control. The full version includes the runtime engine and NI MAX tools, where NI MAX is the user interface for controlling the device.

You can download the latest NI-VISA runtime engine or full version from the NI official website. Their installation steps are basically the same.

Please refer to the following steps to install NI-VISA (the example uses the full version of NI-VISA5.4):

- a. Download the appropriate version of NI-VISA.
- b. Double-click visa540\_full.exe, and the dialog box will pop up as follows:

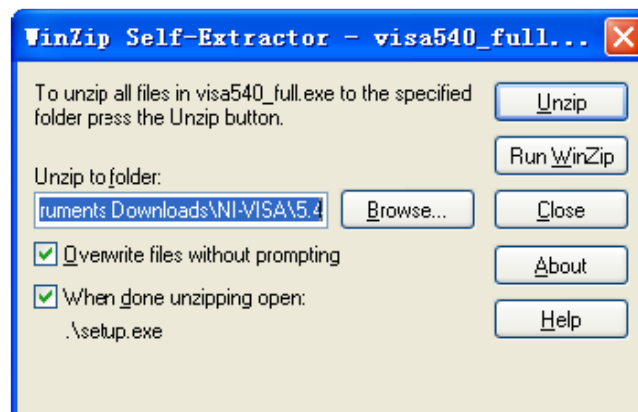

- c. Click Unzip. Then the installation process will launch automatically after unzipping files. If your computer needs to install the .NET Framework 4, it shall auto-start.



- d. The NI-VISA install dialog is shown above. Click Next to start the installation process.

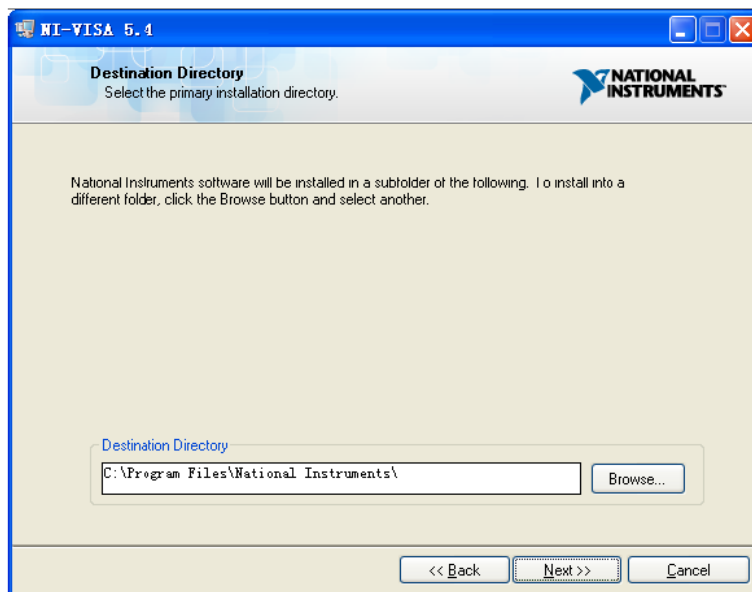

- e. Set the installation path. The default path is “C:\Program Files\National Instruments\”. You can also modify the installation path. Click Next and the dialog box will appear as shown below.

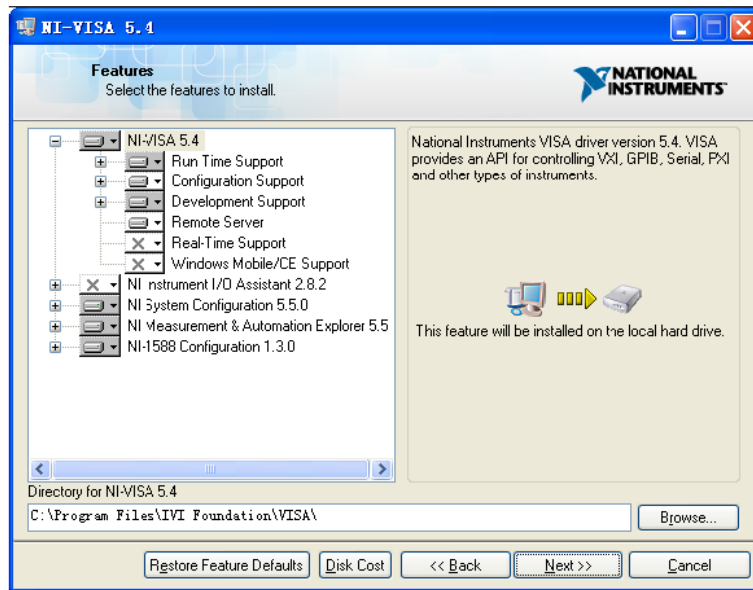

- f. Click Next twice. In the License Agreement dialog, select “I accept the above 2 License Agreement(s).” and click Next. The dialog box will appear as shown below:

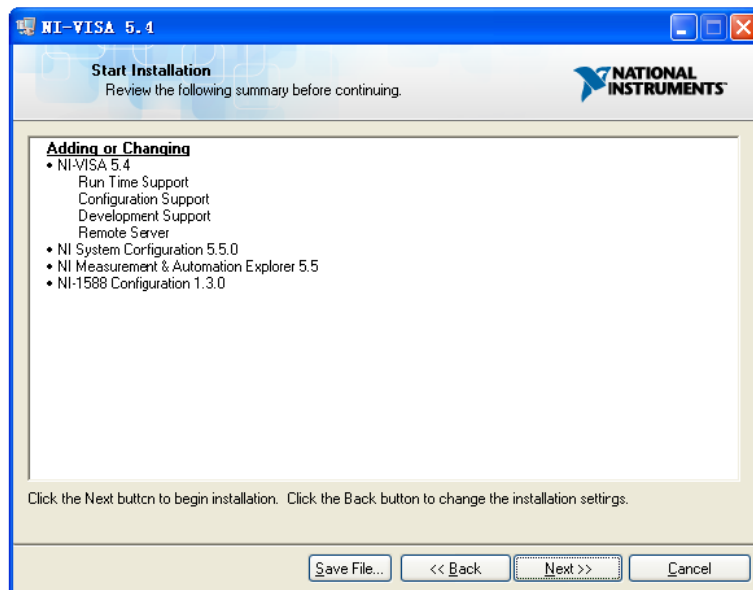

- g. Click Next to begin installation.

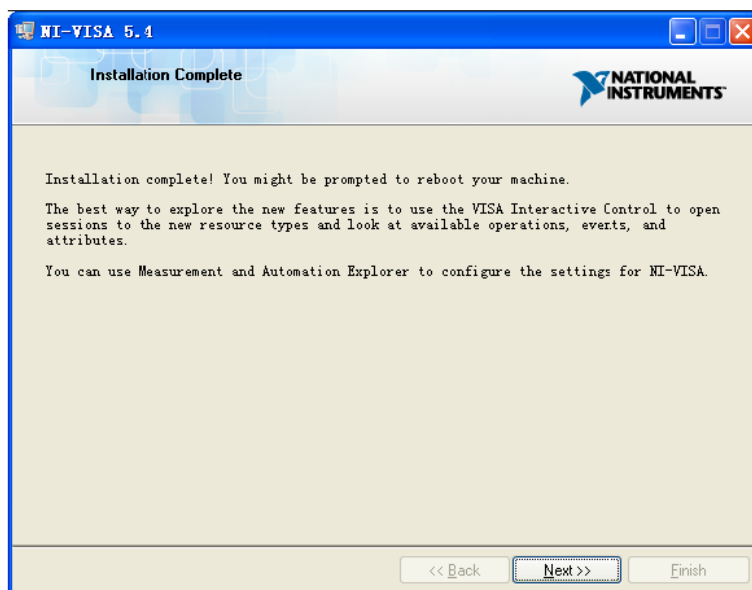

h. Now the installation is complete. Reboot your computer.

## 1.1.2 Connect the instrument to computer

The signal generator may be able to communicate with the computer through the USB, LAN or USB-GPIB interface.

### 1.1.2.1 Connect using USB interface

Please refer to the following steps to finish the connection via the USB interface:

1. Install NI-VISA on your computer to obtain the USB-TMC driver.
2. Connect the USB Device interface of the signal generator to the USB Host interface of the computer with a USB A-B cable.
3. Turn on the signal generator.

The signal generator will be automatically detected as a new USB device.

### 1.1.2.2 Connect using LAN interface

Please refer to the following steps to finish the connection via the LAN interface:

1. Install NI-VISA on your computer to obtain the VXI driver.
2. Use a network cable to connect the signal generator to your computer or the local area network.
3. Turn on the signal generator.
4. Press **UTILITY** → Interface to enter the LAN Setting menu.
5. Set the LAN as Static or DHCP:
  - ◆ DHCP: The DHCP server in the current network will automatically assign network parameters (IP address, subnet mask, gateway) to the signal generator.



- ◆ **Static:** You can manually set the IP address, subnet mask, and gateway.

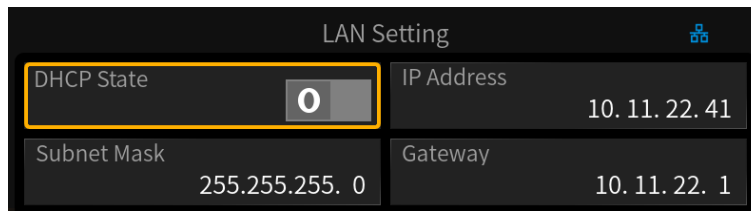

The signal generator will be automatically or manually detected as a new LAN device.

### 1.1.2.3 Connect using USB Host interface (With USB-GPIB Adaptor)

Please refer to the following steps to finish the connection via the LAN interface:

1. Install the NI-VISA GPIB driver on the computer.
2. Use the SIGLENT USB-GPIB adapter to connect the USB Host interface of the signal generator to the GPIB interface of the computer.



3. Turn on the signal generator.
4. Press **UTILITY** → Interface and enter the GPIB number in GPIB Address.

The signal generator will be automatically detected as a new GPIB device.

## 1.2 Remote Control

### 1.2.1 User-defined Programming

Users can send SCPI commands through the computer to program and control the signal generator. For details, please refer to the introduction in the “Programming Examples” chapter.

### 1.2.2 Send SCPI via NI-MAX

NI-MAX is a program created and maintained by National Instruments. It provides basic remote-control interfaces for VXI, LAN, USB, GPIB, and Serial communications. Users can send SCPI commands through NI-MAX to remotely control the signal generator.

The following describes the steps for connecting a device through a USB, LAN, or GPIB interface in NI-MAX and sending SCPI to the device.

#### 1.2.2.1 Using USB

1. Run NI-MAX.
2. Click “Devices and Interfaces” in the upper left corner of the software.
3. Find the USBTMC device symbol:  .
4. Select the signal generator device and click the “Open VISA Test Panel” button.

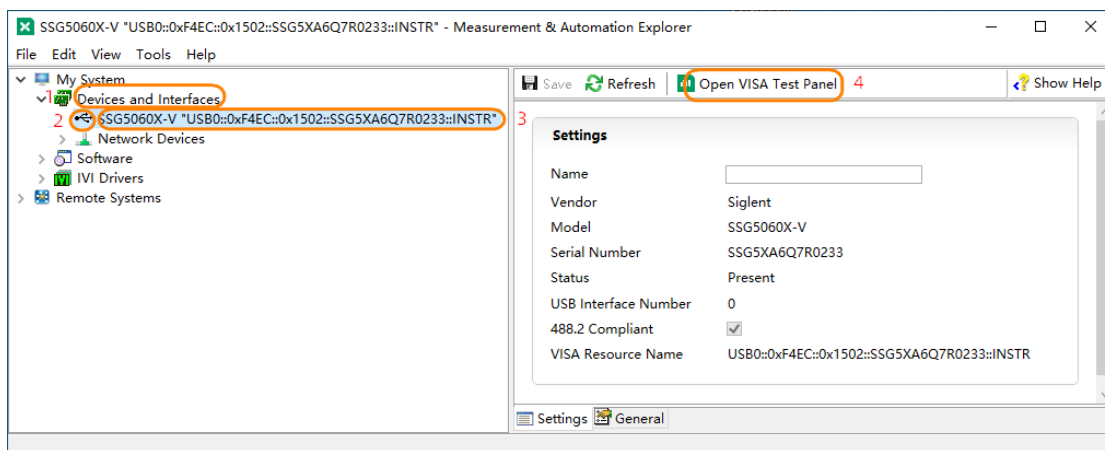

5. Select the “Input/Output” page in the VISA test panel. At this time, you can enter SCPI in the input field to write or query. Click the “Query” button as shown below to query the device’s IDN:

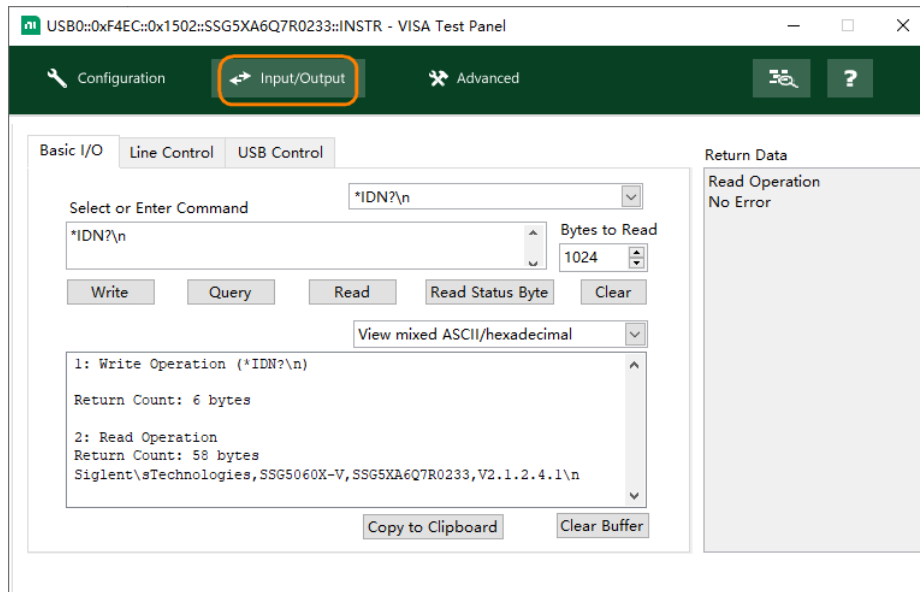

### 1.2.2.2 Using LAN

1. Run NI-MAX.
2. Click “Devices and Interfaces” > “Network Devices” in the upper left corner of the software.
3. Click “Add Network Device” > “VISA TCP/IP Resource...”.

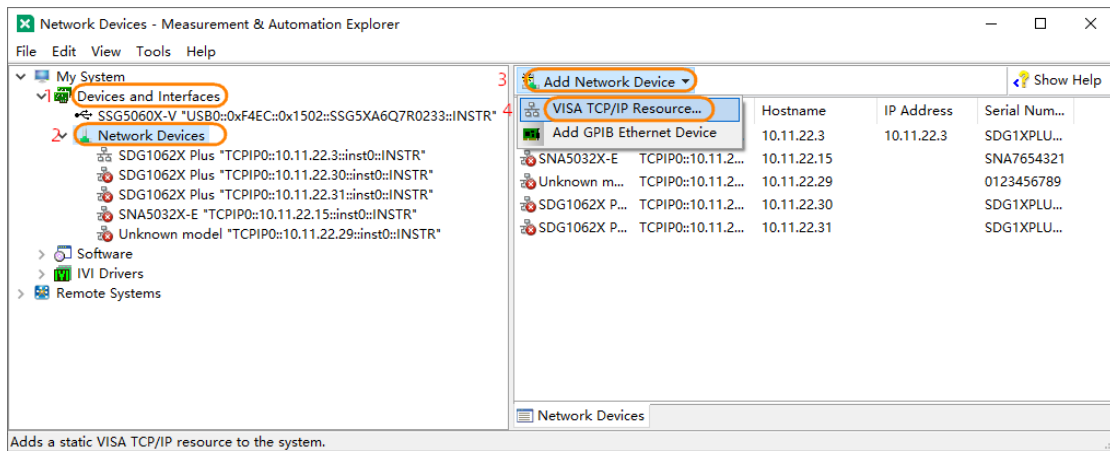

4. In the pop-up “Create New...” window, select "Manual Entry of LAN Instrument" and then click Next.

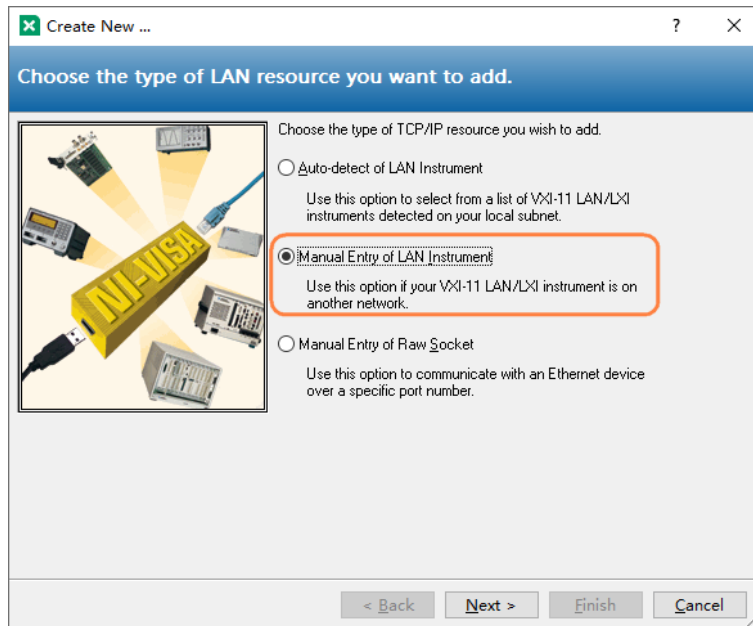

5. Enter the IP address of the signal generator in "Hostname or IP address". You can click "Validate" to verify whether the device can be connected via the entered IP.

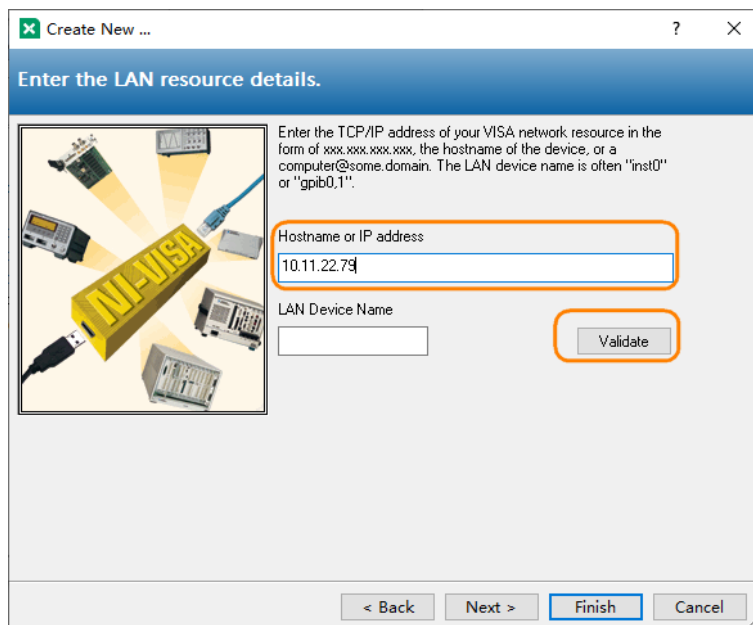

6. Click "Finish" to establish the connection.
7. After a short scan, the resource name of the signal generator should be displayed under "Network Devices".

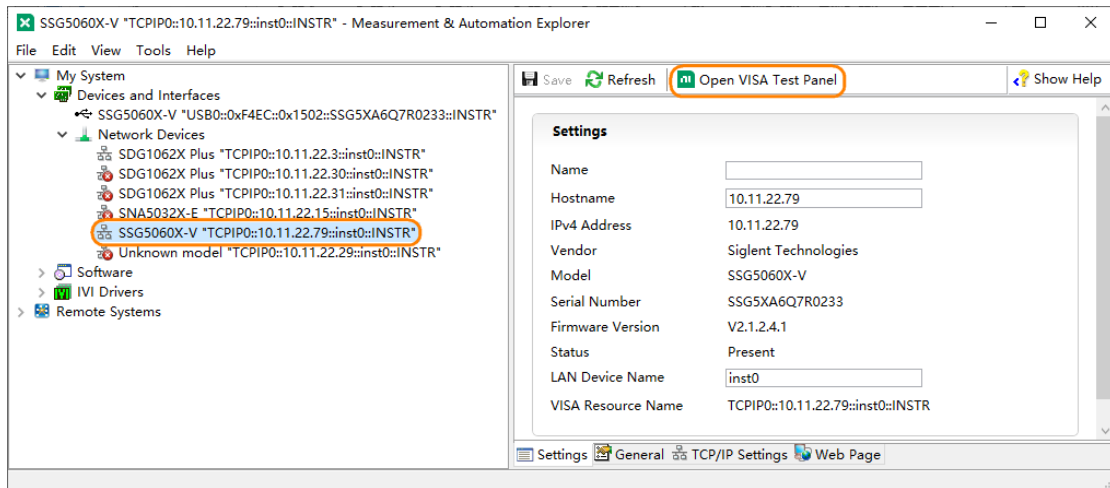

8. Select the signal generator device and click the “Open VISA Test Panel” button.
9. Select the “Input/Output” page in the VISA test panel. At this time, you can enter SCPI in the input field to write or query. Click the “Query” button as shown below to query the device’s IDN:

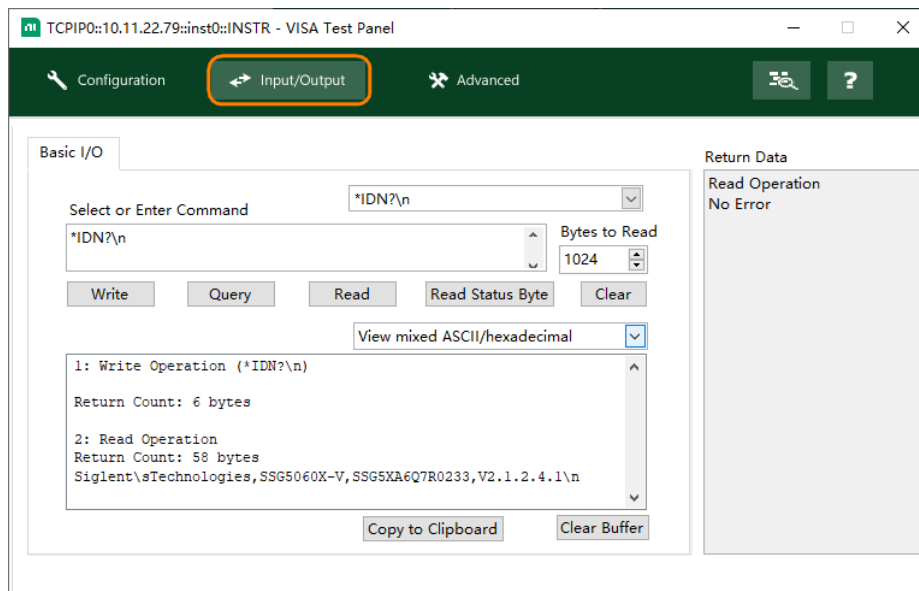

### 1.2.2.3 Using USB-GPIB

1. Run NI-MAX.
2. Click “Devices and Interfaces” in the upper left corner of the software.
3. Find the “GPIB-USB-HS” device symbol.
4. Select the signal generator device and click the “Open VISA Test Panel” button.

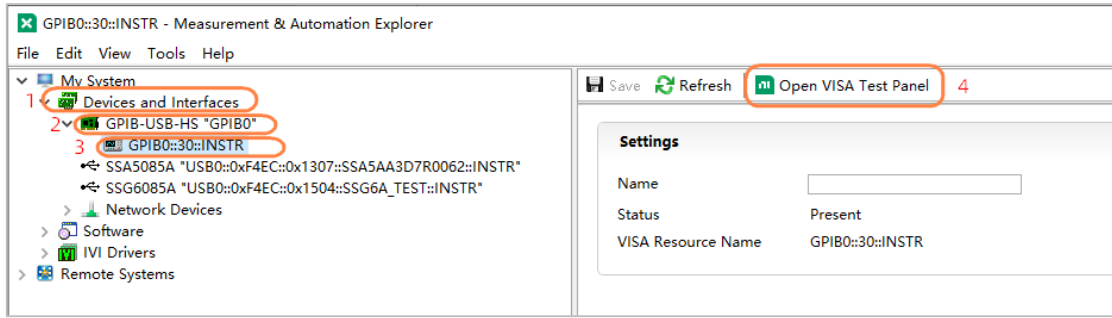

5. Select the “Configuration” > “I/O Settings” in the VISA test panel. Check the Enable Termination Character option, and click Apply Changes button.

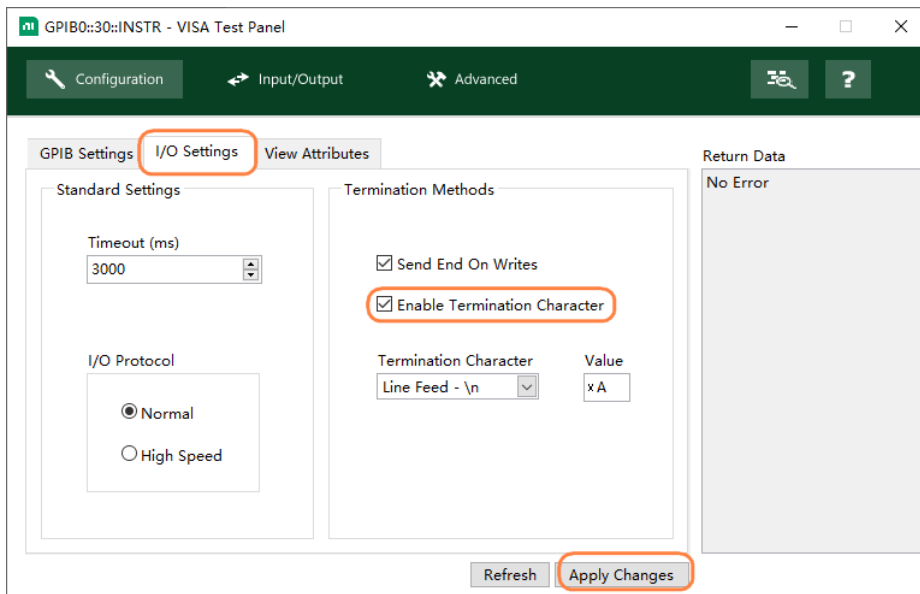

6. Select the “Input/Output” page in the VISA test panel. At this time, you can enter SCPI in the input field to write or query. Click the “Query” button as shown below to query the device’s IDN:

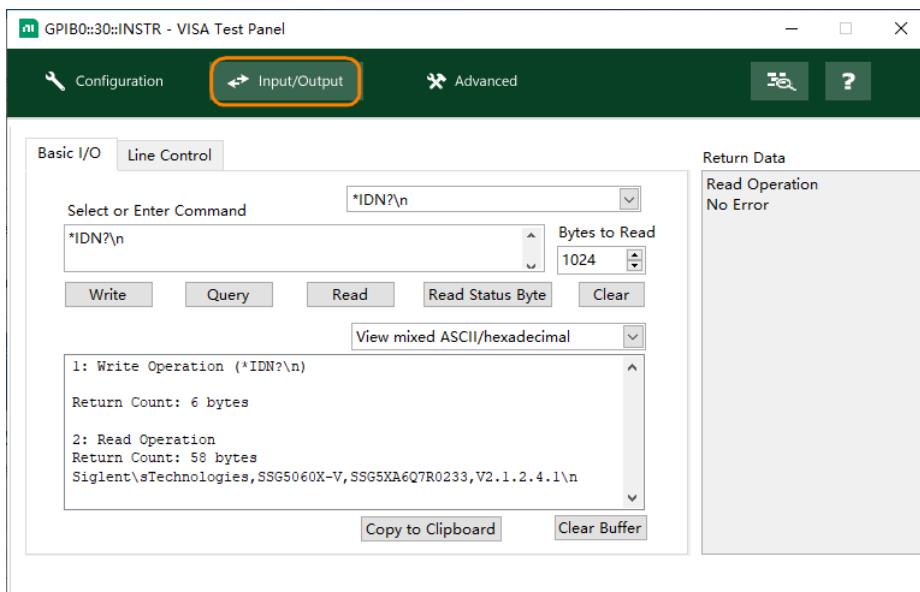

### 1.2.3 Send SCPI over Telnet

Telnet provides a way to communicate with the signal generator through the LAN interface. The Telnet protocol supports sending SCPI commands from the computer to the signal generator in a manner similar to communicating with the signal generator via USB. Sending and receiving information is interactive, and only one command can be sent at a time. Windows operating systems use a command prompt style interface as a Telnet client.

The steps are as follows:

1. On the computer desktop, click Start, then right-click and select Run. Enter `cmd` in the run window and click OK. The command prompt window opens.



```
管理员: C:\Windows\system32\cmd.exe
Microsoft Windows [版本 10.0.19044.1766]
(c) Microsoft Corporation. 保留所有权利。
C:\Users\Administrator>
```

2. In the command prompt window, enter `telnet <IP address> 5024` and press Enter. A Telnet window that can communicate with the instrument will pop up:

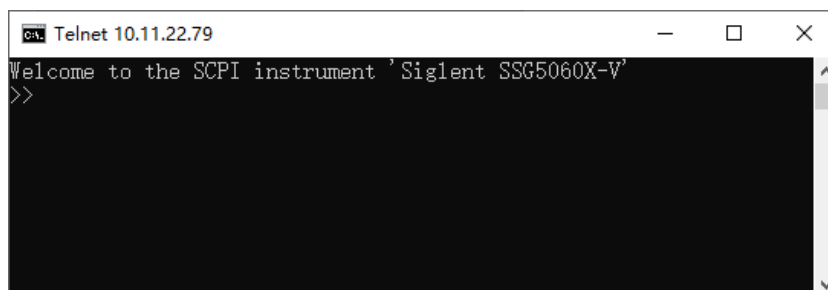

```
Telnet 10.11.22.79
Welcome to the SCPI instrument 'Siglent SSG5060X-V'
>>
```

3. After the “>>” prompt, you can enter a SCPI command to remotely control the signal generator. For example, enter `*IDN?`, this command will return the company name, machine model, serial number and firmware version number.

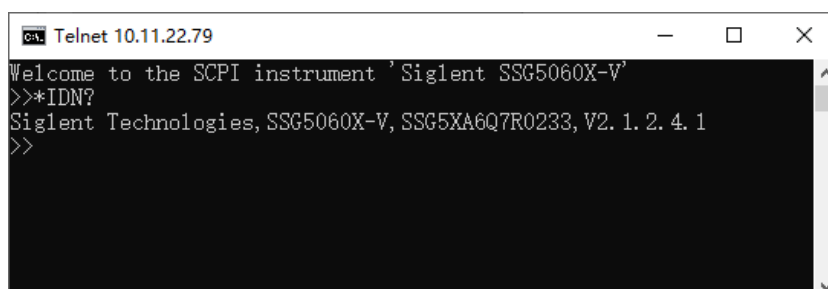

```
Telnet 10.11.22.79
Welcome to the SCPI instrument 'Siglent SSG5060X-V'
>>*IDN?
Siglent Technologies, SSG5060X-V, SSG5XA6Q7R0233, V2. 1. 2. 4. 1
>>
```

4. Press `Ctrl+]` keys simultaneously to exit the SCPI session with the instrument.



```

Microsoft Telnet 10.11.22.79
欢迎使用 Microsoft Telnet Client
Escape 字符为 'CTRL+]'
Microsoft Telnet>

```

5. To re-enter the SCPI session with the instrument, you can enter `open <IP Address> 5024` and press Enter.

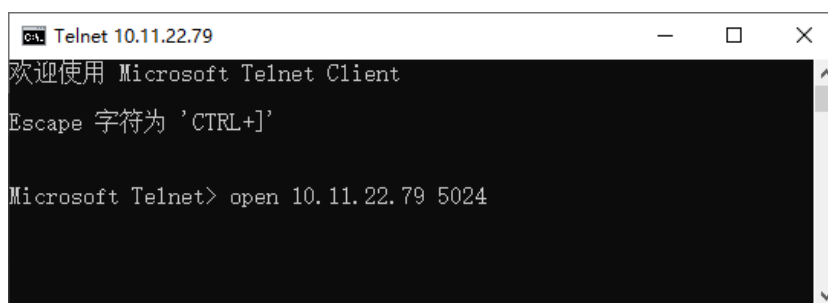

```

Microsoft Telnet 10.11.22.79
欢迎使用 Microsoft Telnet Client
Escape 字符为 'CTRL+]'
Microsoft Telnet> open 10.11.22.79 5024

```

6. To close the Telnet window, type `Quit` and press Enter.

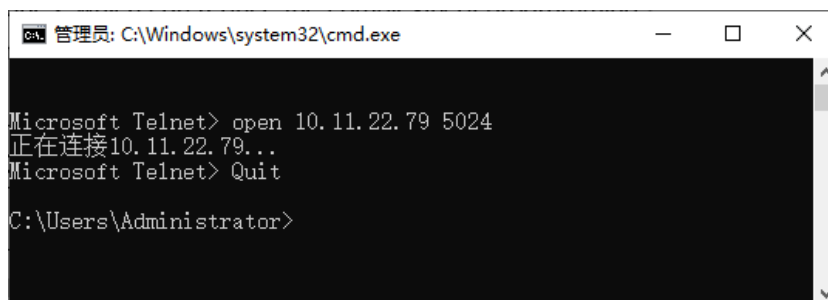

```

管理员: C:\Windows\system32\cmd.exe
Microsoft Telnet> open 10.11.22.79 5024
正在连接10.11.22.79...
Microsoft Telnet> Quit
C:\Users\Administrator>

```

#### 1.2.4 Send SCPI over Socket

Socket API can be used to control the signal generator through the LAN interface without installing any other libraries, which can reduce the complexity of programming.

For detailed information, please refer to the “Socket Examples” chapter of “Programming Examples”.

<b>SOCKET ADDRESS</b>	IP address + port number
<b>IP ADDRESS</b>	SSG IP address
<b>PORT NUMBER</b>	5025



## 2 Introduction to the SCPI Language

### 2.1 Command Format

SCPI commands are tree-like hierarchical structures, including multiple subsystems. Each subsystem consists of a root keyword and one or several hierarchical keywords. The command line usually starts with a colon ":" and keywords are separated by a colon ":". The keyword is followed by optional parameter settings. The command and parameters are separated by "space". For multiple parameters, the parameters are separated by commas ",". Add a question mark "?" after the command line to indicate querying this function.

For example:

```
:SOURce:FREQuency <freq>
```

```
:SOURce:FREQuency?
```

SOURce is the root keyword of the command, and FREQuency is the second-level keyword. The command line starts with a colon ":", and colons separate keywords at each level. <freq> represents a settable parameter. The command: SOURce:FREQuency and the parameter <freq> are separated by a "space". The question mark "?" indicates query, and the instrument will return a response string after receiving the query command.

### 2.2 Symbol Instruction

The following are the symbols used in the SCPI commands:

#### 1. Angular brackets < >

The contents in angular brackets < > are command parameters and must be replaced with a valid value. For example:

POWer:SPC:TARGet <power> command, you can send as POWer:SPC:TARGet 0.

#### 2. Square brackets [ ]

Contents in square brackets (command keywords or default parameters) can be omitted. If you omit the keyword in square brackets, the command still produces the same effect. If a default parameter in square brackets is omitted, the default parameter still takes effect.

#### 3. Vertical lines |

Vertical bars are used to separate multiple enumeration values, one of which must be selected when sending a command. For example:

In the `[:SOURce]:AM:STATe OFF|ON|0|1` command, the optional command parameters are "OFF", "ON", "0" or "1".

#### 4. Braces { }

Parameters in braces are optional and may not be set, or may be set once or multiple times. For example:

In the `:CALCulate:LLINe[1]2:DATA <x-axis>,<ampl>{,<x-axis>,<ampl>}` command, `{,<x-axis>,<ampl>}` in braces can be omitted, or one or more pairs of frequency and amplitude parameters can be set.

## 2.3 Parameter Type

The parameters in the commands introduced in this manual include 6 types: Boolean, enumeration, integer, float, string and discrete.

### 1. Boolean

The parameter in the command could be "OFF", "ON", "0" or "1".

For example:

```
[:SOURce]:FM:STATe OFF|ON|0|1
```

### 2. Enumeration

Parameter should be one of the listed values.

For example:

In `[:SOURce]:SWEep:STATe OFF|FREQuency|LEVe|LEV_FREQ` command, valid parameters are "OFF", "FREQuency", "LEVe" or "LEV\_FREQ".

### 3. Integer

Unless otherwise stated, the parameter can be any integer within the valid value range.

For example:

In `[:SOURce]:SWEep:STEP:POINts <value>` command, the parameter `<value>` can be set to any integer between 2 and 65535.

### 4. Float

Parameters can take any value within the valid range according to accuracy requirements (usually the default accuracy is nine decimal places).

For example:

In `[:SOURce]:POWer:OFFSet <value>` command, the parameter `<value>` can be set to any real number between -100 and 100.

## 5. String

The parameter should be the combination of ASCII characters.

For example:

In `:SYSTem:COMMunicate:LAN:IPADdress <"xxx.xxx.xxx.xxx">` command, the IP address can be set as the string "192.168.1.12".

## 6. Discrete

The parameter could only be one of the specified values and these values are discontinuous.

For example:

In `[:SENSe]:BWIDth:VIDeo:RATio <number>` command, the parameter `<number>` could only be one of 0.001, 0.003, 0.01, 0.03, 0.1, 0.3, 1.0, 3.0, 10.0, 30.0, 100.0, 300.0, 1000.0.

## 2.4 Command Abbreviation

All SCPI commands are case-insensitive. You can enter the complete command in all uppercase or all lowercase. You can also use abbreviations, in which case the abbreviated command must contain all uppercase letters in the command format.

For example:

`:CORRection:FLATness:COUNT?`

You can send in any of the following writing methods:

`:CORRection:FLATness:COUNT?`

`:CORRECTION:FLATNESS:COUNT?`

`:correction:flatness:count?`

You can also abbreviate it to:

`:CORR:FLAT:COUN?`

## 3 Commands

### 3.1 IEEE 488.2 Common Commands

The IEEE standards defined the common commands used for querying the basic information of the instrument and performing basic operations. These commands usually start with "\*" and the length of the command keyword is usually 3 characters.

#### 3.1.1 Identification Query (\*IDN?)

<b>SYNTAX</b>	*IDN?
<b>DESCRIPTION</b>	This command reads the product information (manufacturer, device model, serial number, and firmware revision number) of the device.
<b>EQUIVALENT MENU</b>	None
<b>EXAMPLE</b>	<i>*IDN?</i> Return: <i>Siglent Technologies,SSG5060X-V,SSG5XA6Q7R0233,V2.1.2.4.1</i>

#### 3.1.2 Reset (\*RST)

<b>SYNTAX</b>	*RST
<b>DESCRIPTION</b>	Restore the device state to its initial state.
<b>EQUIVALENT MENU</b>	None
<b>EXAMPLE</b>	<i>*RST</i>

#### 3.1.3 Clear Status (\*CLS)

<b>SYNTAX</b>	*CLS
<b>DESCRIPTION</b>	Clear the values of all status event registers and clear the error queue.
<b>EQUIVALENT MENU</b>	None
<b>EXAMPLE</b>	<i>*CLS</i>

#### 3.1.4 Standard Event Status Enable (\*ESE)

<b>SYNTAX</b>	*ESE <number> *ESE?
<b>DESCRIPTION</b>	This command sets/gets the value of the Standard Event Status Enable Register.

<b>DATA TYPE</b>	Integer
<b>RANGE</b>	0 to 255
<b>EQUIVALENT MENU</b>	None
<b>EXAMPLE</b>	<i>*ESE 16</i> <i>*ESE?</i> Return: <i>16</i>

### 3.1.5 Standard Event Status Register Query (\*ESR?)

<b>SYNTAX</b>	<i>*ESR?</i>
<b>DESCRIPTION</b>	This command reads the value of the Standard Event Status Register. Execution of this command clears the register value.
<b>EQUIVALENT MENU</b>	None
<b>EXAMPLE</b>	<i>*ESR?</i> Return: <i>0</i>

### 3.1.6 Operation Complete Query (\*OPC)

<b>SYNTAX</b>	<i>*OPC</i> <i>*OPC?</i>
<b>DESCRIPTION</b>	This command sets/gets 1 the OPC bit (bit 0) of the Standard Event Status Register when all of pending operations complete.
<b>EQUIVALENT MENU</b>	None
<b>EXAMPLE</b>	<i>*OPC</i> <i>*OPC?</i> Return: <i>1</i>

### 3.1.7 Service Request Enable (\*SRE)

<b>SYNTAX</b>	<i>*SRE &lt;integer&gt;</i> <i>*SRE?</i>
<b>DESCRIPTION</b>	This command sets/gets the value of Service Request Enable Register.
<b>DATA TYPE</b>	Integer
<b>RANGE</b>	0 to 255
<b>EQUIVALENT MENU</b>	None
<b>EXAMPLE</b>	<i>*SRE 24</i>

*\*SRE?*

Return:

*24\n*

---

### 3.1.8 Status Byte Query (\*STB?)

---

<b>SYNTAX</b>	<i>*STB?</i>
<b>DESCRIPTION</b>	This command reads the value of Status Byte Register.
<b>EQUIVALENT MENU</b>	None
<b>EXAMPLE</b>	<i>*STB?</i> Return: <i>72\n</i>

---

### 3.1.9 Wait-to-Continue (\*WAI)

---

<b>SYNTAX</b>	<i>*WAI</i>
<b>DESCRIPTION</b>	This command waits for the execution of all objects sent before this command to be completed.
<b>EQUIVALENT MENU</b>	None
<b>EXAMPLE</b>	<i>*WAI</i>

---

### 3.1.10 Self Test Query (\*TST?)

---

<b>SYNTAX</b>	<i>*TST?</i>
<b>DESCRIPTION</b>	This command queries the instrument self-test results.
<b>EQUIVALENT MENU</b>	None
<b>EXAMPLE</b>	<i>*TST?</i> Return: <i>0\n</i>

---

## 3.2 SYSTEM Commands

### 3.2.1 System Configuration

#### 3.2.1.1 System Time (:SYSTEM:TIME)

<b>SYNTAX</b>	:SYSTEM:TIME <hhmmss> :SYSTEM:TIME?
<b>DESCRIPTION</b>	This command sets/gets the system time.
<b>DATA TYPE</b>	String
<b>RANGE</b>	Hours (0 ~ 23), minutes (0 ~ 59), seconds (0 ~ 59)
<b>RETURN</b>	String
<b>EQUIVALENT MENU</b>	<b>UTILITY</b> > Setting > Time Setting
<b>EXAMPLE</b>	:SYSTEM:TIME 182559 :SYSTEM:TIME? Return: 182613\n

#### 3.2.1.2 System Date (:SYSTEM:DATE)

<b>SYNTAX</b>	:SYSTEM:DATE <yyyymmdd> :SYSTEM:DATE?
<b>DESCRIPTION</b>	This command sets/gets the system date.
<b>DATA TYPE</b>	String
<b>RANGE</b>	Years (four digits), month (1 ~ 12), date (1 ~ 31)
<b>RETURN</b>	String
<b>EQUIVALENT MENU</b>	<b>UTILITY</b> > Setting > Time Setting
<b>EXAMPLE</b>	:SYSTEM:DATE 20050101 :SYSTEM:DATE? Return: 20050101\n

#### 3.2.1.3 IP Address (:SYSTEM:COMMunicate:LAN:IPADdress)

<b>SYNTAX</b>	:SYSTEM:COMMunicate:LAN:IPADdress <"xxx.xxx.xxx.xxx"> :SYSTEM:COMMunicate:LAN:IPADdress?
<b>DESCRIPTION</b>	This command sets/gets the IP address of the device when the IP assignment is set to Static.
<b>DATA TYPE</b>	String
<b>RANGE</b>	Conforms to the IP address standard (0-255:0-255:0-255:0-255)
<b>RETURN</b>	String
<b>EQUIVALENT MENU</b>	<b>UTILITY</b> > Interface > LAN Setting > IP Address

---

**EXAMPLE**                    :*SYSTem:COMMunicate:LAN:IPADdress* "192.168.1.12"  
                                   :*SYSTem:COMMunicate:LAN:IPADdress?*  
 Return:  
 "192.168.1.12"  
 "

---

### 3.2.1.4 Gateway (:SYSTem:COMMunicate:LAN:GATeway)

---

**SYNTAX**                    :*SYSTem:COMMunicate:LAN:GATeway* <"xxx.xxx.xxx.xxx">  
                                   :*SYSTem:COMMunicate:LAN:GATeway?*

---

**DESCRIPTION**            This command sets/gets the gateway of the device when the IP assignment is set to Static.

---

**DATA TYPE**                String

---

**RANGE**                    Conforms to the IP address standard (0-255:0-255:0-255:0-255)

---

**RETURN**                   String

---

**EQUIVALENT MENU**        UTILITY > Interface > LAN Setting > Gateway

---

**EXAMPLE**                   :*SYSTem:COMMunicate:LAN:GATeway* "192.168.1.1"  
                                   :*SYSTem:COMMunicate:LAN:GATeway?*  
 Return:  
 "192.168.1.1"  
 "

---

### 3.2.1.5 Subnet Mask (:SYSTem:COMMunicate:LAN:SMASk)

---

**SYNTAX**                    :*SYSTem:COMMunicate:LAN:SMASk* <"xxx.xxx.xxx.xxx">  
                                   :*SYSTem:COMMunicate:LAN:SMASk?*

---

**DESCRIPTION**            This command sets/gets the subnet mask of the device when the IP assignment is set to Static.

---

**DATA TYPE**                String

---

**RANGE**                    Conforms to the IP address standard (0-255:0-255:0-255:0-255)

---

**RETURN**                   String

---

**EQUIVALENT MENU**        UTILITY > Interface > LAN Setting > Subnet Mask

---

**EXAMPLE**                   :*SYSTem:COMMunicate:LAN:SMASk* "255.255.255.0"  
                                   :*SYSTem:COMMunicate:LAN:SMASk?*  
 Return:  
 "255.255.255.0"  
 "

---

### 3.2.1.6 IP Config (:SYSTem:COMMunicate:LAN:TYPE)

---

**SYNTAX**                    :*SYSTem:COMMunicate:LAN:TYPE* STATIC|DHCP  
                                   :*SYSTem:COMMunicate:LAN:TYPE?*

---

**DESCRIPTION**            This command sets/gets IP assignment type.

---

**DATA TYPE**                Enumeration

---

**RANGE**                    STATIC|DHCP

---

**RETURN**                   Enumeration

---



---

**EQUIVALENT MENU**     **UTILITY** > Interface > LAN Setting > DHCP State

---

**EXAMPLE**                *:SYSTem:COMMunicate:LAN:TYPE STATIC*  
*:SYSTem:COMMunicate:LAN:TYPE?*  
 Return:  
*STATIC\n*

---

### 3.2.1.7 Language (SYSTem:LANGuage)

---

**SYNTAX**                 *:SYSTem:LANGuage CHINese|ENGLish*  
*:SYSTem:LANGuage?*

---

**DESCRIPTION**         This command sets/gets the system language.

---

**DATA TYPE**             Enumeration

---

**RANGE**                 CHINese|ENGLish

---

**RETURN**                Enumeration

---

**EQUIVALENT MENU**     **UTILITY** > Setting > Language

---

**EXAMPLE**                *:SYSTem:LANGuage CHINese*  
*:SYSTem:LANGuage?*  
 Return:  
*CHINese\n*

---

### 3.2.1.8 Screen Saver (SYSTem:SCReen:SAVer)

---

**SYNTAX**                 *:SYSTem:SCReen:SAVer*  
*OFF|10S|1MIN|5MIN|15MIN|30MIN|1HOUR|2HOUR*  
*:SYSTem:SCReen:SAVer?*

---

**DESCRIPTION**         This command sets/gets the type of system screen saver.

---

**DATA TYPE**             Enumeration

---

**RANGE**                 OFF|10S|1MIN|5MIN|15MIN|30MIN|1HOUR|2HOUR

---

**RETURN**                Enumeration

---

**DEFAULT VALUE**        OFF

---

**EQUIVALENT MENU**     **UTILITY** > Setting > Screen Saver

---

**EXAMPLE**                *:SYSTem:SCReen:SAVer 30MIN*  
*:SYSTem:SCReen:SAVer?*  
 Return:  
*30MIN\n*

---

### 3.2.1.9 Beeper (SYSTem:ALARm)

---

**SYNTAX**                 *:SYSTem:ALARm ON|OFF|1|0*  
*:SYSTem:ALARm?*

---

**DESCRIPTION**         This command sets/gets the state of system beeper.

---

**DATA TYPE**             Boolean

---

<b>RANGE</b>	ON OFF 1 0
<b>RETURN</b>	1 0
<b>DEFAULT VALUE</b>	0
<b>EQUIVALENT MENU</b>	<b>UTILITY</b> > Setting > Beeper
<b>EXAMPLE</b>	<i>:SYSTem:ALARm ON</i> <i>:SYSTem:ALARm?</i> Return: <i>1</i>

### 3.2.1.10 Setup Type (:SYSTem:PON:TYPE)

<b>SYNTAX</b>	<i>:SYSTem:PON:TYPE DFT LAST</i> <i>:SYSTem:PON:TYPE?</i>
<b>DESCRIPTION</b>	This command sets/gets the system startup type.
<b>DATA TYPE</b>	Enumeration
<b>RANGE</b>	DFT LAST
<b>RETURN</b>	Enumeration
<b>DEFAULT VALUE</b>	None
<b>EQUIVALENT MENU</b>	<b>UTILITY</b> > Setting > Setup Type
<b>EXAMPLE</b>	<i>:SYSTem:PON:TYPE LAST</i> <i>:SYSTem:PON:TYPE?</i> Return: <i>LAST</i>

### 3.2.1.11 Power On Line (SYSTem:POWeron:TYPE)

<b>SYNTAX</b>	<i>:SYSTem:POWeron:TYPE ON OFF 1 0</i> <i>:SYSTem:POWeron:TYPE?</i>
<b>DESCRIPTION</b>	This command sets/gets whether the system is powered on or not.
<b>DATA TYPE</b>	Boolean
<b>RANGE</b>	ON OFF 1 0
<b>RETURN</b>	1 0
<b>DEFAULT VALUE</b>	0
<b>EQUIVALENT MENU</b>	<b>UTILITY</b> > Setting > Power On Line
<b>EXAMPLE</b>	<i>:SYSTem:POWeron:TYPE ON</i> <i>:SYSTem:POWeron:TYPE?</i> Return: <i>1</i>

**3.2.1.12 10M Adjustment State (:SYSTem:REF:DAC:STAT)**

<b>SYNTAX</b>	:SYSTem:REF:DAC:STAT ON OFF 1 0 :SYSTem:REF:DAC:STAT?
<b>DESCRIPTION</b>	This command sets/gets the state of system 10M adjustment.
<b>DATA TYPE</b>	Boolean
<b>RANGE</b>	ON OFF 1 0
<b>RETURN</b>	1 0
<b>DEFAULT VALUE</b>	0
<b>EQUIVALENT MENU</b>	<b>UTILITY</b> > Setting > 10M Adjustment
<b>EXAMPLE</b>	:SYSTem:REF:DAC:STAT ON :SYSTem:REF:DAC:STAT? Return: 1\n

**3.2.1.13 Ref Osc Code (:SYSTem:REF:DAC)**

<b>SYNTAX</b>	:SYSTem:REF:DAC <value> :SYSTem:REF:DAC?
<b>DESCRIPTION</b>	This command sets/gets the system reference oscillator code.
<b>DATA TYPE</b>	Integer
<b>RANGE</b>	0 to 65535
<b>RETURN</b>	Integer
<b>DEFAULT VALUE</b>	None
<b>EQUIVALENT MENU</b>	<b>UTILITY</b> > Setting > 10M Adjustment > Ref Osc Code
<b>EXAMPLE</b>	:SYSTem:REF:DAC 43000 :SYSTem:REF:DAC? Return: 43000\n

**3.2.1.14 Ref Osc Code Store (:SYSTem:REF:DAC:SAVE)**

<b>SYNTAX</b>	:SYSTem:REF:DAC:SAVE <"file_name">
<b>DESCRIPTION</b>	This command saves the system's reference oscillator code into a DAC file.
<b>DATA TYPE</b>	String
<b>RANGE</b>	None
<b>EQUIVALENT MENU</b>	<b>UTILITY</b> > Setting > 10M Adjustment > Save Ref Osc Setting
<b>EXAMPLE</b>	:SYSTem:REF:DAC:SAVE "U-disk3/test.dac"

**3.2.1.15 Ref Osc Code Load (:SYSTem:REF:DAC:LOAD)**

<b>SYNTAX</b>	:SYSTem:REF:DAC:LOAD <"file_name">
<b>DESCRIPTION</b>	This command loads the reference oscillator code from a DAC file.
<b>DATA TYPE</b>	String
<b>RANGE</b>	None
<b>EQUIVALENT MENU</b>	<span style="border: 1px solid black; padding: 2px;">UTILITY</span> > Setting > 10M Adjustment > Recall Ref Osc Setting
<b>EXAMPLE</b>	<i>:SYSTem:REF:DAC:LOAD "U-disk3/test.dac"</i>

**3.2.1.16 Reset Ref Osc Code to Default (:SYSTem:REF:DAC:DEFAult)**

<b>SYNTAX</b>	II
<b>DESCRIPTION</b>	This command resets the reference oscillator code to default value.
<b>EQUIVALENT MENU</b>	<span style="border: 1px solid black; padding: 2px;">I</span>
<b>EXAMPLE</b>	<i>:SYSTem:REF:DAC:DEFAult</i>

**3.2.1.17 GPIB Address (SYSTem:GPIB)**

<b>SYNTAX</b>	:SYSTem:GPIB <value> :SYSTem:GPIB?
<b>DESCRIPTION</b>	This command sets/gets the GPIB address of the device.
<b>DATA TYPE</b>	Integer
<b>RANGE</b>	1 to 30
<b>RETURN</b>	Integer
<b>DEFAULT VALUE</b>	18
<b>EQUIVALENT MENU</b>	<span style="border: 1px solid black; padding: 2px;">UTILITY</span> > Interface > GPIB Address
<b>EXAMPLE</b>	<i>:SYSTem:GPIB 10</i> <i>:SYSTem:GPIB?</i> Return: <i>10\n</i>

**3.2.1.18 Quit Remote Control State (SYSTem:REMOte 0)**

<b>SYNTAX</b>	:SYSTem:REMOte 0
<b>DESCRIPTION</b>	Send this command to exit the remote mode of the system.
<b>EQUIVALENT MENU</b>	<span style="border: 1px solid black; padding: 2px;">ESC</span>
<b>EXAMPLE</b>	<i>:SYSTem:REMOte 0</i>

## 3.2.2 System Reset/Preset

### 3.2.2.1 System Preset (:SYSTem:PRESet)

<b>SYNTAX</b>	:SYSTem:PRESet
<b>DESCRIPTION</b>	This command presets the status of the instrument based on the preset type.
<b>EQUIVALENT MENU</b>	<b>UTILITY</b> > Preset, or PRESET
<b>EXAMPLE</b>	<p>Reset the instrument to its default configuration:  <i>:SYSTem:PRESet:TYPE DFT</i>  <i>:SYSTem:PRESet</i></p> <p>Reset the instrument to its current configuration:  <i>:SYSTem:PRESet:TYPE USER</i>  <i>:SYSTem:PRESet:SAVE</i>  <i>:SYSTem:PRESet</i></p> <p>Reset instrument to configuration in an XML file:  <i>:SYSTem:PRESet:TYPE USER</i>  <i>:SYSTem:PRESet:PATH "Local/test.xml"</i>  <i>:SYSTem:PRESet</i></p>

### 3.2.2.2 Preset Save (:SYSTem:PRESet:SAVE)

<b>SYNTAX</b>	:SYSTem:PRESet:SAVE
<b>DESCRIPTION</b>	This command saves the current system configuration.
<b>EQUIVALENT MENU</b>	None
<b>EXAMPLE</b>	<p>Reset the instrument to its current configuration:  <i>:SYSTem:PRESet:TYPE USER</i>  <i>:SYSTem:PRESet:SAVE</i>  <i>:SYSTem:PRESet</i></p>

### 3.2.2.3 Preset Path (:SYSTem:PRESet:PATH)

<b>SYNTAX</b>	:SYSTem:PRESet:PATH <"file_name">
<b>DESCRIPTION</b>	This command saves the current system configuration into an XML file.
<b>DATA TYPE</b>	String
<b>RANGE</b>	None
<b>EQUIVALENT MENU</b>	<b>UTILITY</b> > Setting > Preset Type (User) > Save
<b>EXAMPLE</b>	<p><i>:SYSTem:PRESet:PATH "Local/test.xml"</i>  <i>:SYSTem:PRESet:PATH "U-disk1/test.xml"</i></p>

### 3.2.2.4 Preset Type (:SYSTem:PRESet:TYPE)

<b>SYNTAX</b>	:SYSTem:PRESet:TYPE DFT USER :SYSTem:PRESet:TYPE?
---------------	--

<b>DESCRIPTION</b>	This command sets/gets the preset type of the system.
<b>DATA TYPE</b>	Enumeration
<b>RANGE</b>	DFT USER
<b>RETURN</b>	Enumeration
<b>DEFAULT VALUE</b>	DFT
<b>EQUIVALENT MENU</b>	<span style="border: 1px solid black; padding: 2px;">UTILITY</span> > Setting > Preset Type
<b>EXAMPLE</b>	<i>:SYSTem:PRESet:TYPE DFT</i> <i>:SYSTem:PRESet:TYPE?</i> Return: <i>DFT</i>

### 3.2.2.5 Factory Reset (:SYSTem:FDEFault)

<b>SYNTAX</b>	:SYSTem:FDEFault
<b>DESCRIPTION</b>	This command restores the instrument status to factory settings.
<b>EQUIVALENT MENU</b>	<span style="border: 1px solid black; padding: 2px;">UTILITY</span> > Setting > Factory Reset
<b>EXAMPLE</b>	<i>:SYSTem:FDEFault</i>

### 3.2.2.6 Reset & Clear (SYSTem:RESet:CLEAr)

<b>SYNTAX</b>	:SYSTem:RESet:CLEAr
<b>DESCRIPTION</b>	Restore the instrument status to factory settings and clear the user files in the Local folder.
<b>EQUIVALENT MENU</b>	<span style="border: 1px solid black; padding: 2px;">UTILITY</span> > Setting > Reset & Clear
<b>EXAMPLE</b>	<i>:SYSTem:RESet:CLEAr</i>

### 3.3 OUTPUT Commands

#### 3.3.1 RF Output (:OUTPUT[:STATE])

<b>SYNTAX</b>	:OUTPUT[:STATE] ON OFF 1 0 :OUTPUT[:STATE]?
<b>DESCRIPTION</b>	This command sets/gets the output status of the RF port.
<b>DATA TYPE</b>	Boolean
<b>RANGE</b>	ON OFF 1 0
<b>RETURN</b>	1 0
<b>DEFAULT VALUE</b>	0
<b>EQUIVALENT SCPI</b>	[:SOURCE]:OUTPUT ON OFF 1 0
<b>EQUIVALENT MENU</b>	<input type="checkbox"/> RF ON/OFF or <input type="checkbox"/> FREQ > RF State
<b>EXAMPLE</b>	<i>OUTPUT ON</i> <i>:OUTPUT?</i> Return: <i>1</i>

#### 3.3.2 Analog Modulation State (:OUTPUT:MODULATION[:STATE])

<b>SYNTAX</b>	:OUTPUT:MODULATION[:STATE] ON OFF 1 0 :OUTPUT:MODULATION[:STATE]?
<b>DESCRIPTION</b>	This command sets/gets the switch status of analog modulation.
<b>DATA TYPE</b>	Boolean
<b>RANGE</b>	ON OFF 1 0
<b>RETURN</b>	1 0
<b>DEFAULT VALUE</b>	0
<b>EQUIVALENT SCPI</b>	[:SOURCE]:MODULATION ON OFF 1 0 [:SOURCE]:MODULATION?
<b>EQUIVALENT MENU</b>	ANALOG MOD > On
<b>EXAMPLE</b>	<i>:OUTPUT:MODULATION ON</i> <i>:OUTPUT:MODULATION?</i> Return: <i>1</i>

## 3.4 SOURce Commands

### 3.4.1 RF Output ([:SOURce]:OUTPut)

SYNTAX	[:SOURce]:OUTPut ON OFF 1 0
DESCRIPTION	This command sets the output status of the RF port.
DATA TYPE	Boolean
RANGE	ON OFF 1 0
EQUIVALENT SCPI	:OUTPut[:STATe] ON OFF 1 0
EQUIVALENT MENU	<input type="checkbox"/> RF ON/OFF or <input type="checkbox"/> FREQ > RF State
EXAMPLE	<i>:SOURce:OUTPut ON</i>

### 3.4.2 Software Trigger[:SOURce]:\*TRG)

SYNTAX	[:SOURce]:*TRG
DESCRIPTION	When the trigger source is Bus, execute software trigger.  <b>Note:</b> the trigger functions involved include sweep trigger, point sweep trigger, LF sweep trigger, pulse modulation trigger, ARB trigger and IoT trigger, etc.
EQUIVALENT MENU	None
EXAMPLE	<i>*TRG</i>

### 3.4.3 Frequency

#### 3.4.3.1 Frequency Display ([:SOURce]:FREQuency:DISPlay)

SYNTAX	[:SOURce]:FREQuency:DISPlay <freq> [:SOURce]:FREQuency:DISPlay?
DESCRIPTION	This command sets/gets the frequency display value in the parameter bar at the top of the screen.
DATA TYPE	Float, unit: Hz, kHz, MHz or GHz, default is Hz
RANGE	Frequency offset + Full frequency range
RETURN	Float, unit: Hz
DEFAULT VALUE	Maximum frequency
EQUIVALENT MENU	Freq
EXAMPLE	<i>:FREQuency:DISPlay 2 MHz</i> <i>:FREQuency:DISPlay?</i> Return: <i>2000000\n</i>



### 3.4.3.2 Frequency ([:SOURce]:FREQuency)

<b>SYNTAX</b>	<code>[:SOURce]:FREQuency &lt;freq&gt;</code> <code>[:SOURce]:FREQuency?</code>
<b>DESCRIPTION</b>	This command sets/gets the frequency of the RF output signal.
<b>DATA TYPE</b>	Float, unit: Hz, kHz, MHz or GHz, default is Hz
<b>RANGE</b>	Full frequency range
<b>RETURN</b>	Float, unit: Hz
<b>DEFAULT VALUE</b>	Maximum frequency
<b>EQUIVALENT MENU</b>	<code>FREQ</code> > Frequency
<b>EXAMPLE</b>	<code>:FREQuency 2 MHz</code> <code>:FREQuency?</code> Return: <code>2000000\n</code>

### 3.4.3.3 Frequency Offset ([:SOURce]:FREQuency:OFFSet)

<b>SYNTAX</b>	<code>[:SOURce]:FREQuency:OFFSet &lt;freq&gt;</code> <code>[:SOURce]:FREQuency:OFFSet?</code>
<b>DESCRIPTION</b>	This command sets/gets the frequency offset of the RF output signal.
<b>DATA TYPE</b>	Float, unit: Hz, kHz, MHz or GHz, default is Hz
<b>RANGE</b>	-200 GHz to 200 GHz
<b>RETURN</b>	Float, unit: Hz
<b>DEFAULT VALUE</b>	0
<b>EQUIVALENT MENU</b>	<code>FREQ</code> > Freq Offset
<b>EXAMPLE</b>	<code>:FREQuency:OFFSet -2 MHz</code> <code>:FREQuency:OFFSet?</code> Return: <code>-2000000\n</code>

### 3.4.3.4 Phase Offset ([:SOURce]:PHASe)

<b>SYNTAX</b>	<code>[:SOURce]:PHASe &lt;phase&gt;</code> <code>[:SOURce]:PHASe?</code>
<b>DESCRIPTION</b>	This command sets/gets the phase of the RF output signal.
<b>DATA TYPE</b>	Float, unit: degree
<b>RANGE</b>	-360 ~ 360
<b>RETURN</b>	Float, unit: degree
<b>DEFAULT VALUE</b>	0
<b>EQUIVALENT MENU</b>	<code>FREQ</code> > Phase Offset
<b>EXAMPLE</b>	<code>PHASe 20</code>

*PHASe?*

Return:

*20\n***3.4.3.5 Phase Reset ([:SOURce]:PHASe:RESet)**

<b>SYNTAX</b>	[:SOURce]:PHASe:RESet
<b>DESCRIPTION</b>	This command resets the phase offset display value of the RF signal to 0.
<b>EQUIVALENT SCPI</b>	[:SOURce]:PHASe:REF
<b>EQUIVALENT MENU</b>	<input type="text" value="FREQ"/> > Reset phase delta display
<b>EXAMPLE</b>	<i>:PHASe:RESet</i>

**3.4.3.6 Phase Reset ([:SOURce]:PHASe:REF)**

<b>SYNTAX</b>	[:SOURce]:PHASe:REF
<b>DESCRIPTION</b>	This command resets the phase offset display value of the RF signal to 0.
<b>EQUIVALENT SCPI</b>	[:SOURce]:PHASe:RESet
<b>EQUIVALENT MENU</b>	<input type="text" value="FREQ"/> > Reset phase delta display
<b>EXAMPLE</b>	<i>:PHASe:REF</i>

**3.4.4 Level****3.4.4.1 Level Display ([:SOURce]:POWer:POWer)**

<b>SYNTAX</b>	[:SOURce]:POWer:POWer <power> [:SOURce]:POWer:POWer?
<b>DESCRIPTION</b>	This command sets/gets the level display value in the parameter bar at the top of the screen.
<b>DATA TYPE</b>	Float, unit: dBm, dBuV, uV, mV, V, nW, uW, mW or W, default is dBm
<b>RANGE</b>	Level Offset + Full power range
<b>RETURN</b>	Float, unit: dBm
<b>DEFAULT VALUE</b>	-130 dBm
<b>EQUIVALENT MENU</b>	Level
<b>EXAMPLE</b>	<i>:POWer:POWer -2</i> <i>:POWer:POWer?</i> Return: <i>-2\n</i>

## 3.4.4.2 Level ([:SOURce]:POWER)

<b>SYNTAX</b>	[:SOURce]:POWER <power> [:SOURce]:POWER?
<b>DESCRIPTION</b>	This command sets/gets the level of the RF output signal.
<b>DATA TYPE</b>	Float, unit: dBm, dBuV, uV, mV, V, nW, uW, mW or W, default is dBm
<b>RANGE</b>	Please refer to SSG5000X datasheet
<b>RETURN</b>	Float, unit: dBm
<b>DEFAULT VALUE</b>	-130 dBm
<b>EQUIVALENT MENU</b>	<input type="text" value="LEVEL"/> > Level
<b>EXAMPLE</b>	<i>:POWER 2</i> <i>:POWER?</i> Return: <i>2</i>

## 3.4.4.3 Level ([:SOURce]:POWER[:LEVel][:IMMediate][:AMPLitude])

<b>SYNTAX</b>	[:SOURce]:POWER[:LEVel][:IMMediate][:AMPLitude] <power> [:SOURce]:POWER[:LEVel][:IMMediate][:AMPLitude]?
<b>DESCRIPTION</b>	This command sets/gets the level of the RF output signal.
<b>DATA TYPE</b>	Float, unit: dBm, dBuV, uV, mV, V, nW, uW, mW or W, default is dBm
<b>RANGE</b>	Please refer to SSG5000X datasheet
<b>RETURN</b>	Float, unit: dBm
<b>DEFAULT VALUE</b>	-130 dBm
<b>EQUIVALENT MENU</b>	<input type="text" value="LEVEL"/> > Level
<b>EXAMPLE</b>	<i>:POWER:LEVel -5</i> <i>:POWER:LEVel?</i> Return: <i>-5</i>

## 3.4.4.4 Level Offset ([:SOURce]:POWER:OFFSet)

<b>SYNTAX</b>	[:SOURce]:POWER:OFFSet <power> [:SOURce]:POWER:OFFSet?
<b>DESCRIPTION</b>	This command sets/gets the level offset of the RF output signal.
<b>DATA TYPE</b>	Float, unit: dB
<b>RANGE</b>	-100 dB to 100 dB
<b>RETURN</b>	Float, unit: dB
<b>DEFAULT VALUE</b>	0
<b>EQUIVALENT MENU</b>	<input type="text" value="LEVEL"/> > Level Offset
<b>EXAMPLE</b>	<i>:POWER:OFFSet 2</i>

---

```
:POWer:OFFSet?
```

```
Return:
```

```
2\n
```

---

#### 3.4.4.5 ALC State ([:SOURce]:POWER:ALC)

<b>SYNTAX</b>	<i>[:SOURce]:POWER:ALC ON OFF AUTO</i> <i>[:SOURce]:POWER:ALC?</i>
<b>DESCRIPTION</b>	This command sets/gets the ALC state.
<b>DATA TYPE</b>	Enumeration
<b>RANGE</b>	ON OFF AUTO
<b>RETURN</b>	Enumeration
<b>DEFAULT VALUE</b>	AUTO
<b>EQUIVALENT MENU</b>	<b>LEVEL</b> > ALC State
<b>EXAMPLE</b>	<i>:POWer:ALC ON</i> <i>:POWer:ALC?</i> Return: <i>ON\n</i>

#### 3.4.4.6 Flatness List State ([:SOURce]:CORRection[:FLATness])

<b>SYNTAX</b>	<i>[:SOURce]:CORRection[:FLATness] ON OFF 1 0</i> <i>[:SOURce]:CORRection[:FLATness]?</i>
<b>DESCRIPTION</b>	This command sets/gets the state of flatness correction.
<b>DATA TYPE</b>	Boolean
<b>RANGE</b>	ON OFF 1 0
<b>RETURN</b>	1 0
<b>DEFAULT VALUE</b>	0
<b>EQUIVALENT MENU</b>	<b>LEVEL</b> > Flatness
<b>EXAMPLE</b>	<i>:CORRection:FLATness ON</i> <i>:CORRection?</i> Return: <i>1\n</i>

#### 3.4.4.7 Flatness List Add Row ([:SOURce]:CORRection:FLATness:PAIR)

<b>SYNTAX</b>	<i>[:SOURce]:CORRection:FLATness:PAIR &lt;freq&gt;,&lt;power&gt;</i>
<b>DESCRIPTION</b>	This command adds a line to the flatness list.
<b>DATA TYPE</b>	Freq: float, unit: Hz, kHz, MHz or GHz, default is Hz, Power: float, unit: dB
<b>RANGE</b>	Freq: Full frequency range, Power: -100 to 100

---

**EQUIVALENT MENU**     `LEVEL` > Flatness > Add

---

**EXAMPLE**                     *`CORRection:FLATness:PAIR 3 MHz,-3`*

---

#### 3.4.4.8 Flatness List Delete Row (`[[:SOURce]:CORRection:FLATness:DELeTe]`)

---

**SYNTAX**                     `[[:SOURce]:CORRection:FLATness:DELeTe <row>`

---

**DESCRIPTION**             This command removes a specified row from the flatness list.

---

**DATA TYPE**                 Integer

---

**RANGE**                      1 ~ total number of rows in the flatness list

---

**EQUIVALENT MENU**     `LEVEL` > Flatness > Delete

---

**EXAMPLE**                     *`:CORRection:FLATness:DELeTe 1`*

---

#### 3.4.4.9 Flatness List Count (`[[:SOURce]:CORRection:FLATness:COUNT?]`)

---

**SYNTAX**                     `[[:SOURce]:CORRection:FLATness:COUNT?`

---

**DESCRIPTION**             This command queries the total number of rows of the flatness list.

---

**RETURN**                     Integer

---

**DEFAULT VALUE**          0

---

**EQUIVALENT MENU**     `LEVEL` > Flatness

---

**EXAMPLE**                     *`:CORRection:FLATness:COUNT?`*  
 Return:  
*`5`*

---

#### 3.4.4.10 Flatness List Store (`[[:SOURce]:CORRection:STORe]`)

---

**SYNTAX**                     `[[:SOURce]:CORRection:STORe <"file_name">`

---

**DESCRIPTION**             This command saves the flatness list into a UFLT file.

---

**DATA TYPE**                 String

---

**RANGE**                      None

---

**EQUIVALENT MENU**     `LEVEL` > Flatness > Save

---

**EXAMPLE**                     *`:CORRection:STORe "U-disk3/test.uflt"`*

---

#### 3.4.4.11 Flatness List Load (`[[:SOURce]:CORRection:LOAD]`)

---

**SYNTAX**                     `[[:SOURce]:CORRection:LOAD <"file_name">`

---

**DESCRIPTION**             This command loads the flatness list from a UFLT file.

---

**DATA TYPE**                 String

---

**RANGE**                      None

---

---

**EQUIVALENT MENU**     `LEVEL` > Flatness > Open

---

**EXAMPLE**                     `:CORRection:LOAD "U-disk3/test.uflt"`

---

#### 3.4.4.12 Flatness List Clear ([:SOURce]:CORRection:FLATness:PRESet)

---

**SYNTAX**                     `[:SOURce]:CORRection:FLATness:PRESet`

---

**DESCRIPTION**             This command clears the flatness list.

---

**EQUIVALENT MENU**     `LEVEL` > Flatness > Clear

---

**EXAMPLE**                     `:CORRection:FLATness:PRESet`

---

#### 3.4.4.13 Flatness List Fill Type ([:SOURce]:CORRection:FLATness:FILL:TYPE)

---

**SYNTAX**                     `[:SOURce]:CORRection:FLATness:FILL:TYPE`  
`FLATness|MANUal|SWEEPlist`  
`[:SOURce]:CORRection:FLATness:FILL:TYPE?`

---

**DESCRIPTION**             This command sets/gets the fill type of the flatness list.

---

**DATA TYPE**                 Enumeration

---

**RANGE**                      `FLATness|MANUal|SWEEPlist`

---

**RETURN**                    Enumeration

---

**DEFAULT VALUE**           `FLATness`

---

**EQUIVALENT MENU**     `LEVEL` > Flatness > Setting > Fill Type

---

**EXAMPLE**                     `:CORRection:FLATness:FILL:TYPE FLATness`  
`:CORRection:FLATness:FILL:TYPE?`  
 Return:  
`FLATness\n`

---

#### 3.4.4.14 Flatness List Start Freq ([:SOURce]:CORRection:FLATness:STARTfreq)

---

**SYNTAX**                     `[:SOURce]:CORRection:FLATness:STARTfreq <freq>`  
`[:SOURce]:CORRection:FLATness:STARTfreq?`

---

**DESCRIPTION**             When the flatness list needs to be filled with a power sensor and the filling type is "Manual Step", this command sets/queries the starting frequency of manual step filling.

---

**DATA TYPE**                 Float, unit: Hz, kHz, MHz or GHz, default is Hz

---

**RANGE**                      Full frequency range

---

**RETURN**                    Float, unit: Hz

---

**DEFAULT VALUE**           Maximum frequency

---

**EQUIVALENT MENU**     `LEVEL` > Flatness > Setting > Fill Type (Manual Step) > Start Freq

---

**EXAMPLE**                     `:CORRection:FLATness:STARTfreq 200 MHz`  
`:CORRection:FLATness:STARTfreq?`  
 Return:  
`200000000\n`

---

**3.4.4.15 Flatness List Stop Freq ([:SOURce]:CORRection:FLATness:STOPfreq)**

<b>SYNTAX</b>	<code>[:SOURce]:CORRection:FLATness:STOPfreq &lt;freq&gt;</code> <code>[:SOURce]:CORRection:FLATness:STOPfreq?</code>
<b>DESCRIPTION</b>	When the flatness list needs to be filled with a power sensor and the filling type is “Manual Step”, this command sets/queries the end frequency of manual step filling.
<b>DATA TYPE</b>	Float, unit: Hz, kHz, MHz or GHz, default is Hz
<b>RANGE</b>	Full frequency range
<b>RETURN</b>	Float, unit: Hz
<b>DEFAULT VALUE</b>	Maximum frequency
<b>EQUIVALENT MENU</b>	<b>LEVEL</b> > Flatness > Setting > Fill Type (Manual Step) > Stop Freq
<b>EXAMPLE</b>	<code>:CORRection:FLATness:STOPfreq 500 MHz</code> <code>:CORRection:FLATness:STOPfreq?</code> Return: <code>500000000\n</code>

**3.4.4.16 Flatness List Fill Space ([:SOURce]:CORRection:FLATness:SPACE)**

<b>SYNTAX</b>	<code>[:SOURce]:CORRection:FLATness:SPACE LINear LOGarithmic</code> <code>[:SOURce]:CORRection:FLATness:SPACE?</code>
<b>DESCRIPTION</b>	When the flatness list needs to be filled with a power sensor and the filling type is “Manual Step”, this command sets/queries the frequency step method of manual step filling.
<b>DATA TYPE</b>	Enumeration
<b>RANGE</b>	LINear LOGarithmic
<b>RETURN</b>	Enumeration
<b>DEFAULT VALUE</b>	LINear
<b>EQUIVALENT MENU</b>	<b>LEVEL</b> > Flatness > Setting > Fill Type (Manual Step) > Fill Space
<b>EXAMPLE</b>	<code>:CORRection:FLATness:SPACE LINear</code> <code>:CORRection:FLATness:SPACE?</code> Return: <code>LINear\n</code>

**3.4.4.17 Flatness List Linear Step ([:SOURce]:CORRection:FLATness:LINStep)**

<b>SYNTAX</b>	<code>[:SOURce]:CORRection:FLATness:LINStep &lt;freq&gt;</code> <code>[:SOURce]:CORRection:FLATness:LINStep?</code>
<b>DESCRIPTION</b>	This command sets/queries the linear frequency step of manual step filling.
<b>DATA TYPE</b>	Float, unit: Hz, kHz, MHz or GHz, default is Hz
<b>RETURN</b>	Float, unit: Hz
<b>DEFAULT VALUE</b>	0

---

**EQUIVALENT MENU**    **LEVEL** > Flatness > Setting > Fill Type (Manual Step) > Step Linear

---

**EXAMPLE**                    *:CORRection:FLATness:LINStep 200 MHz*  
                                   *:CORRection:FLATness:LINStep?*  
 Return:  
                                   *200000000\n*

---

#### 3.4.4.18 Flatness List Log Step (**[[:SOURce]:CORRection:FLATness:LOGStep**)

---

**SYNTAX**                    **[[:SOURce]:CORRection:FLATness:LOGStep <value>**  
**[[:SOURce]:CORRection:FLATness:LOGStep?**

---

**DESCRIPTION**            This command sets/queries the logarithmic frequency step of manual step filling.

---

**DATA TYPE**                Float, unit: %

---

**RETURN**                    Float, unit: %

---

**DEFAULT VALUE**         0

---

**EQUIVALENT MENU**    **LEVEL** > Flatness > Setting > Fill Type (Manual Step) > Step Log

---

**EXAMPLE**                    *:CORRection:FLATness:LOGStep 20*  
                                   *:CORRection:FLATness:LOGStep?*  
 Return:  
                                   *20\n*

---

#### 3.4.4.19 Flatness List Points (**[[:SOURce]:CORRection:FLATness:POINT**)

---

**SYNTAX**                    **[[:SOURce]:CORRection:FLATness:POINT <points>**  
**[[:SOURce]:CORRection:FLATness:POINT?**

---

**DESCRIPTION**            This command sets/queries the sweep points of manual step filling.

---

**DATA TYPE**                Integer

---

**RANGE**                     2 to 500

---

**RETURN**                    Integer

---

**DEFAULT VALUE**         2

---

**EQUIVALENT MENU**    **LEVEL** > Flatness > Setting > Fill Type (Manual Step) > Points

---

**EXAMPLE**                    *:CORRection:FLATness:POINT 5*  
                                   *:CORRection:FLATness:POINT?*  
 Return:  
                                   *5\n*

---

#### 3.4.4.20 Fill Flatness with Sensor (**[[:SOURce]:CORRection:CSET:DATA[:SENSor][:POWER]:SONCe**)

---

**SYNTAX**                    **[[:SOURce]:CORRection:CSET:DATA[:SENSor][:POWER]:SONCe**

---

**DESCRIPTION**            Amplitude correction values to populate flatness list with power sensor.

---



---

**EQUIVALENT MENU**     `LEVEL` > Flatness > Setting > Fill Flatness with Sensor

---

**EXAMPLE**                     `:CORRection:CSET:DATA:SONCe`

---

### 3.4.5 Sweep

#### 3.4.5.1 Sweep State ([:SOURce]:SWEep:STATe)

---

**SYNTAX**                     `[:SOURce]:SWEep:STATe OFF|FREQuency|LEVe|LEV_FREQ`  
`[:SOURce]:SWEep:STATe?`

---

**DESCRIPTION**             This command sets/gets the sweep state.

---

**DATA TYPE**                Enumeration

---

**RANGE**                     OFF|FREQuency|LEVe|LEV\_FREQ

---

**RETURN**                    Enumeration

---

**DEFAULT VALUE**          OFF

---

**EQUIVALENT MENU**     `SWEEP` > Sweep State

---

**EXAMPLE**                     `:SWEep:STATe LEV_FREQ`  
`:SWEep:STATe?`  
 Return:  
`LEV_FREQ`

---

#### 3.4.5.2 Sweep Type ([:SOURce]:SWEep:TYPE)

---

**SYNTAX**                     `[:SOURce]:SWEep:TYPE LIST|STEP`  
`[:SOURce]:SWEep:TYPE?`

---

**DESCRIPTION**             This command sets the sweep type to step sweep or list sweep.  
 This command queries whether the sweep type is step sweep or list sweep.

---

**DATA TYPE**                Enumeration

---

**RANGE**                     LIST|STEP

---

**RETURN**                    Enumeration

---

**DEFAULT VALUE**          STEP

---

**EQUIVALENT MENU**     `SWEEP` > Step Sweep / List Sweep

---

**EXAMPLE**                     `:SWEep:TYPE STEP`  
`:SWEep:TYPE?`  
 Return:  
`STEP`

---

#### 3.4.5.3 Start Frequency ([:SOURce]:SWEep:STEP:START:FREQuency)

---

**SYNTAX**                     `[:SOURce]:SWEep:STEP:START:FREQuency <freq>`  
`[:SOURce]:SWEep:STEP:START:FREQuency?`

---

**DESCRIPTION**             This command sets/queries the starting frequency of step sweep.

---

<b>DATA TYPE</b>	Float, unit: Hz, kHz, MHz or GHz, default is Hz
<b>RANGE</b>	Full frequency range
<b>RETURN</b>	Float, unit: Hz
<b>DEFAULT VALUE</b>	Maximum frequency
<b>EQUIVALENT MENU</b>	<b>[SWEEP]</b> > Step Sweep > Start Freq
<b>EXAMPLE</b>	<pre>:SWEep:STEP:STARt:FREQuency 1 GHz :SWEep:STEP:STARt:FREQuency? Return: 1000000000\n</pre>

#### 3.4.5.4 Stop Frequency ([:SOURce]:SWEep:STEP:STOP:FREQuency)

<b>SYNTAX</b>	<pre>[:SOURce]:SWEep:STEP:STOP:FREQuency &lt;freq&gt; [:SOURce]:SWEep:STEP:STOP:FREQuency?</pre>
<b>DESCRIPTION</b>	This command sets/queries the stop frequency of step sweep.
<b>DATA TYPE</b>	Float, unit: Hz, kHz, MHz or GHz, default is Hz
<b>RANGE</b>	Full frequency range
<b>RETURN</b>	Float, unit: Hz
<b>DEFAULT VALUE</b>	Maximum frequency
<b>EQUIVALENT MENU</b>	<b>[SWEEP]</b> > Step Sweep > Stop Freq
<b>EXAMPLE</b>	<pre>:SWEep:STEP:STOP:FREQuency 1 GHz :SWEep:STEP:STOP:FREQuency? Return: 1000000000\n</pre>

#### 3.4.5.5 Start Level ([:SOURce]:SWEep:STEP:STARt:LEVel)

<b>SYNTAX</b>	<pre>[:SOURce]:SWEep:STEP:STARt:LEVel &lt;level&gt; [:SOURce]:SWEep:STEP:STARt:LEVel?</pre>
<b>DESCRIPTION</b>	This command sets/queries the starting level of step sweep.
<b>DATA TYPE</b>	Float, unit: dBm, dBuV, uV, mV, V, nW, uW, mW or W, default is dBm
<b>RANGE</b>	Please refer to SSG5000X datasheet
<b>RETURN</b>	Float, unit: dBm
<b>DEFAULT VALUE</b>	-130 dBm
<b>EQUIVALENT MENU</b>	<b>[SWEEP]</b> > Step Sweep > Start Level
<b>EXAMPLE</b>	<pre>:SWEep:STEP:STARt:LEVel 0 dBm :SWEep:STEP:STARt:LEVel? Return: 0\n</pre>

### 3.4.5.6 Stop Level ([:SOURce]:SWEep:STEP:STOP:LEVel)

<b>SYNTAX</b>	<code>[:SOURce]:SWEep:STEP:STOP:LEVel &lt;level&gt;</code> <code>[:SOURce]:SWEep:STEP:STOP:LEVel?</code>
<b>DESCRIPTION</b>	This command sets/queries the stop level of step sweep.
<b>DATA TYPE</b>	Float, unit: dBm, dBuV, uV, mV, V, nW, uW, mW or W, default is dBm
<b>RANGE</b>	Please refer to SSG5000X datasheet
<b>RETURN</b>	Float, unit: dBm
<b>DEFAULT VALUE</b>	-130 dBm
<b>EQUIVALENT MENU</b>	<span style="border: 1px solid black; padding: 2px;">SWEEP</span> > Step Sweep > Stop Level
<b>EXAMPLE</b>	<code>:SWEep:STEP:STOP:LEVel 0 dBm</code> <code>:SWEep:STEP:STOP:LEVel?</code> Return: <code>0\n</code>

### 3.4.5.7 Dwell Time ([:SOURce]:SWEep:STEP:DWELI)

<b>SYNTAX</b>	<code>[:SOURce]:SWEep:STEP:DWELI &lt;time&gt;</code> <code>[:SOURce]:SWEep:STEP:DWELI?</code>
<b>DESCRIPTION</b>	This command sets/queries the dwell time of step sweep.
<b>DATA TYPE</b>	Float, unit: ns, us, ms or s, default is s
<b>RANGE</b>	10 ms ~ 100 s
<b>RETURN</b>	Float, unit: s
<b>DEFAULT VALUE</b>	30 ms
<b>EQUIVALENT MENU</b>	<span style="border: 1px solid black; padding: 2px;">SWEEP</span> > Step Sweep > Dwell Time
<b>EXAMPLE</b>	<code>:SWEep:STEP:DWELI 20 ms</code> <code>:SWEep:STEP:DWELI?</code> Return: <code>0.02\n</code>

### 3.4.5.8 Sweep Points ([:SOURce]:SWEep:STEP:POINts)

<b>SYNTAX</b>	<code>[:SOURce]:SWEep:STEP:POINts &lt;points&gt;</code> <code>[:SOURce]:SWEep:STEP:POINts?</code>
<b>DESCRIPTION</b>	This command sets/queries the sweep points of step sweep.
<b>DATA TYPE</b>	Integer
<b>RANGE</b>	2 to 65535
<b>RETURN</b>	Integer
<b>DEFAULT VALUE</b>	11
<b>EQUIVALENT MENU</b>	<span style="border: 1px solid black; padding: 2px;">SWEEP</span> > Step Sweep > Sweep Points
<b>EXAMPLE</b>	<code>:SWEep:STEP:POINts 2</code>

---

```
:SWEep:STEP:POINts?
```

```
Return:
```

```
2\n
```

---

### 3.4.5.9 Sweep Shape ([:SOURce]:SWEep:STEP:SHAPE)

<b>SYNTAX</b>	<i>[:SOURce]:SWEep:STEP:SHAPE TRlangle SAWtooth [:SOURce]:SWEep:STEP:SHAPE?</i>
<b>DESCRIPTION</b>	This command sets/queries the sweep shape of step sweep.
<b>DATA TYPE</b>	Enumeration
<b>RANGE</b>	TRlangle SAWtooth
<b>RETURN</b>	Enumeration
<b>DEFAULT VALUE</b>	SAWtooth
<b>EQUIVALENT MENU</b>	<b>[SWEEP]</b> > Step Sweep > Sweep Shape
<b>EXAMPLE</b>	<i>:SWEep:STEP:SHAPE TRlangle :SWEep:STEP:SHAPE? Return: TRlangle\n</i>

---

### 3.4.5.10 Sweep Space ([:SOURce]:SWEep:STEP:SPACE)

<b>SYNTAX</b>	<i>[:SOURce]:SWEep:STEP:SPACE LINear LOGarithmic [:SOURce]:SWEep:STEP:SPACE?</i>
<b>DESCRIPTION</b>	This command sets/queries the frequency sweep space of step sweep.
<b>DATA TYPE</b>	Enumeration
<b>RANGE</b>	LINear LOGarithmic
<b>RETURN</b>	Enumeration
<b>DEFAULT VALUE</b>	LINear
<b>EQUIVALENT MENU</b>	<b>[SWEEP]</b> > Step Sweep > Sweep Space
<b>EXAMPLE</b>	<i>:SWEep:STEP:SPACE LOGarithmic :SWEep:STEP:SPACE? Return: LOGarithmic\n</i>

---

### 3.4.5.11 Linear Sweep Step ([:SOURce]:SWEep[:FREQUENCY]:STEP[:LINear])

<b>SYNTAX</b>	<i>[:SOURce]:SWEep[:FREQUENCY]:STEP[:LINear] &lt;freq&gt; [:SOURce]:SWEep[:FREQUENCY]:STEP[:LINear]?</i>
<b>DESCRIPTION</b>	This command sets/queries the linear frequency step of the step sweep.
<b>DATA TYPE</b>	Float, unit: Hz, kHz, MHz or GHz, default is Hz
<b>RANGE</b>	None

---

<b>RETURN</b>	Float, unit: Hz
<b>DEFAULT VALUE</b>	0
<b>EQUIVALENT MENU</b>	<b>[SWEEP]</b> > Step Sweep > Freq Step Linear
<b>EXAMPLE</b>	<i>:SWEep:STEP 200 MHz</i> <i>:SWEep:STEP?</i> Return: <i>200000000\n</i>

#### 3.4.5.12 Logarithmic Sweep Step ([:SOURce]:SWEep[:FREQuency]:STEP:LOGarithmic)

<b>SYNTAX</b>	<i>[:SOURce]:SWEep[:FREQuency]:STEP:LOGarithmic &lt;value&gt;</i> <i>[:SOURce]:SWEep[:FREQuency]:STEP:LOGarithmic?</i>
<b>DESCRIPTION</b>	This command sets/queries the logarithmic frequency step of the step sweep.
<b>DATA TYPE</b>	Float, unit: %
<b>RANGE</b>	None
<b>RETURN</b>	Float, unit: %
<b>DEFAULT VALUE</b>	0
<b>EQUIVALENT MENU</b>	<b>[SWEEP]</b> > Step Sweep > Freq Step Log
<b>EXAMPLE</b>	<i>:SWEep:STEP:LOGarithmic 20</i> <i>:SWEep:STEP:LOGarithmic?</i> Return: <i>20\n</i>

#### 3.4.5.13 Sweep List Add Row ([:SOURce]:SWEep:LIST:ADDList)

<b>SYNTAX</b>	<i>[:SOURce]:SWEep:LIST:ADDList &lt;freq&gt;,&lt;level&gt;,&lt;time&gt;</i>
<b>DESCRIPTION</b>	This command adds a line to the sweep list.
<b>DATA TYPE</b>	Freq: float, unit: Hz, kHz, MHz or GHz, default is Hz, Level: float, unit: dBm, dBuV, uV, mV, V, nW, uW, mW or W, default is dBm, Time: float, unit: ns, us, ms or s, default is s
<b>RANGE</b>	Freq: Full frequency range, Level: Full level range, Time: 10.0 ms ~ 100.0 s
<b>EQUIVALENT MENU</b>	<b>[SWEEP]</b> > List Sweep > Add
<b>EXAMPLE</b>	<i>:SWEep:LIST:ADDList 1 GHz,0 dBm,1 s</i>

#### 3.4.5.14 Sweep List Delete Row ([:SOURce]:SWEep:LIST:DELeTe)

<b>SYNTAX</b>	<i>[:SOURce]:SWEep:LIST:DELeTe &lt;row&gt;</i>
<b>DESCRIPTION</b>	This command removes a specified row from the sweep list.

<b>DATA TYPE</b>	Integer
<b>RANGE</b>	1 ~ total number of rows in the sweep list
<b>EQUIVALENT MENU</b>	<span style="border: 1px solid black; padding: 2px;">SWEEP</span> > List Sweep > Delete
<b>EXAMPLE</b>	<i>:SWEep:LIST:DELeTe 1</i>

#### 3.4.5.15 Sweep List Edit ([:SOURce]:SWEep:LIST:CHANGe)

<b>SYNTAX</b>	[:SOURce]:SWEep:LIST:CHANGe <row>,<freq>,<level>,<time>
<b>DESCRIPTION</b>	This command edits the specified row in the sweep list.
<b>DATA TYPE</b>	Row: Integer, Freq: float, unit: Hz, kHz, MHz or GHz, default is Hz, Level: float, unit: dBm, dBuV, uV, mV, V, nW, uW, mW or W, default is dBm, Time: float, unit: ns, us, ms or s, default is s
<b>RANGE</b>	Row: 1 ~ total number of rows in the sweep list, Freq: Full frequency range, Level: Full level range, Time: 10.0 ms ~ 100.0 s
<b>EQUIVALENT MENU</b>	<span style="border: 1px solid black; padding: 2px;">SWEEP</span> > List Sweep
<b>EXAMPLE</b>	<i>:SWEep:LIST:CHANGe 1,1 GHz,1 dBm, 1 s</i>

#### 3.4.5.16 Sweep List Count ([:SOURce]:SWEep:LIST:CPOint?)

<b>SYNTAX</b>	[:SOURce]:SWEep:LIST:CPOint?
<b>DESCRIPTION</b>	This command queries the total number of rows of the sweep list.
<b>RETURN</b>	Integer
<b>DEFAULT VALUE</b>	1
<b>EQUIVALENT MENU</b>	<span style="border: 1px solid black; padding: 2px;">SWEEP</span> > List Sweep
<b>EXAMPLE</b>	<i>:SWEep:LIST:CPOint?</i> Return: <i>5\n</i>

#### 3.4.5.17 Sweep List Data ([:SOURce]:SWEep:LIST:LIST?)

<b>SYNTAX</b>	[:SOURce]:SWEep:LIST:LIST? <begin_row>,<end_row>
<b>DESCRIPTION</b>	This command queries the data from begin_row to end_row in the sweep list.
<b>DATA TYPE</b>	Integer, Integer
<b>RANGE</b>	1 ~ total number of rows in the sweep list, Start row ~ total number of rows in the sweep list
<b>RETURN</b>	String

<b>DEFAULT VALUE</b>	None
<b>EQUIVALENT MENU</b>	<input type="button" value="SWEEP"/> > List Sweep
<b>EXAMPLE</b>	<i>:SWEep:LIST:LIST? 1,3</i> Return: <i>100000000,0,0.03 2000000000,-2.4,0.03 3000000000,-4.8,0.03\n</i>

#### 3.4.5.18 Sweep List Clear ([:SOURce]:SWEep:LIST:INITialize:PRESet)

<b>SYNTAX</b>	[:SOURce]:SWEep:LIST:INITialize:PRESet
<b>DESCRIPTION</b>	This command clears the sweep list.
<b>EQUIVALENT MENU</b>	<input type="button" value="SWEEP"/> > List Sweep > Clear
<b>EXAMPLE</b>	<i>:SWEep:LIST:INITialize:PRESet</i>

#### 3.4.5.19 Sweep List Initialize From Step Sweep ([:SOURce]:SWEep:LIST:INITialize:FSTep)

<b>SYNTAX</b>	[:SOURce]:SWEep:LIST:INITialize:FSTep
<b>DESCRIPTION</b>	This command imports the sweep list from step sweep.
<b>EQUIVALENT MENU</b>	<input type="button" value="SWEEP"/> > List Sweep > Import
<b>EXAMPLE</b>	<i>:SWEep:LIST:INITialize:FSTep</i>

#### 3.4.5.20 Sweep List Load ([:SOURce]:SWEep:LOAD)

<b>SYNTAX</b>	[:SOURce]:SWEep:LOAD <"file_name">
<b>DESCRIPTION</b>	This command loads the sweep list from a LSW file.
<b>DATA TYPE</b>	String
<b>RANGE</b>	None
<b>EQUIVALENT MENU</b>	<input type="button" value="SWEEP"/> > List Sweep > Open
<b>EXAMPLE</b>	<i>:SWEep:LOAD "U-disk3/test.lsw"</i>

#### 3.4.5.21 Sweep List Store ([:SOURce]:SWEep:STORE)

<b>SYNTAX</b>	[:SOURce]:SWEep:STORE <"file_name">
<b>DESCRIPTION</b>	This command saves the sweep list into a LSW file.
<b>DATA TYPE</b>	String
<b>RANGE</b>	None
<b>EQUIVALENT MENU</b>	<input type="button" value="SWEEP"/> > List Sweep > Save
<b>EXAMPLE</b>	<i>:SWEep:STORE "U-disk3/test.lsw"</i>

**3.4.5.22 Sweep Direction ([:SOURce]:SWEep:DIRect)**

<b>SYNTAX</b>	[:SOURce]:SWEep:DIRect FWD REV [:SOURce]:SWEep:DIRect?
<b>DESCRIPTION</b>	This command sets/queries the sweep direction.
<b>DATA TYPE</b>	Enumeration
<b>RANGE</b>	FWD REV
<b>RETURN</b>	Enumeration
<b>DEFAULT VALUE</b>	FWD
<b>EQUIVALENT MENU</b>	<b>[SWEEP]</b> > Direction
<b>EXAMPLE</b>	<i>:SWEep:DIRect REV</i> <i>:SWEep:DIRect?</i> Return: <i>REVn</i>

**3.4.5.23 Sweep Mode ([:SOURce]:SWEep:MODE)**

<b>SYNTAX</b>	[:SOURce]:SWEep:MODE CONTInue SINGle [:SOURce]:SWEep:MODE?
<b>DESCRIPTION</b>	This command sets the sweep mode to continuous or single. This command queries whether the sweep mode is continuous or single.
<b>DATA TYPE</b>	Enumeration
<b>RANGE</b>	CONTInue SINGle
<b>RETURN</b>	Enumeration
<b>DEFAULT VALUE</b>	CONTInue
<b>EQUIVALENT MENU</b>	<b>[SWEEP]</b> > Sweep Mode
<b>EXAMPLE</b>	<i>:SWEep:MODE SINGle</i> <i>:SWEep:MODE?</i> Return: <i>SINGle</i>

**3.4.5.24 Execute Single Sweep ([:SOURce]:SWEep:EXECute)**

<b>SYNTAX</b>	[:SOURce]:SWEep:EXECute
<b>DESCRIPTION</b>	When the sweep mode is single, this command can perform a single sweep.
<b>EQUIVALENT MENU</b>	<b>[SWEEP]</b> > Execute single sweep
<b>EXAMPLE</b>	<i>:SWEep:EXECute</i>



**3.4.5.25 Trigger Mode ([:SOURce]:SWEep:SWEep:TRIGger:TYPE)**

<b>SYNTAX</b>	<code>[:SOURce]:SWEep:SWEep:TRIGger:TYPE AUTO KEY BUS EXT</code> <code>[:SOURce]:SWEep:SWEep:TRIGger:TYPE?</code>
<b>DESCRIPTION</b>	This command sets/queries the sweep trigger mode.
<b>DATA TYPE</b>	Enumeration
<b>RANGE</b>	AUTO KEY BUS EXT
<b>RETURN</b>	Enumeration
<b>DEFAULT VALUE</b>	AUTO
<b>EQUIVALENT MENU</b>	<span style="border: 1px solid black; padding: 2px;">SWEEP</span> > Trigger Mode
<b>EXAMPLE</b>	<code>:SWEep:SWEep:TRIGger:TYPE KEY</code> <code>:SWEep:SWEep:TRIGger:TYPE?</code> Return: <code>KEYn</code>

**3.4.5.26 Point Trigger ([:SOURce]:SWEep:POINT:TRIGger:TYPE)**

<b>SYNTAX</b>	<code>[:SOURce]:SWEep:POINT:TRIGger:TYPE AUTO KEY BUS EXT</code> <code>[:SOURce]:SWEep:POINT:TRIGger:TYPE?</code>
<b>DESCRIPTION</b>	This command sets/queries the point sweep trigger mode.
<b>DATA TYPE</b>	Enumeration
<b>RANGE</b>	AUTO KEY BUS EXT
<b>RETURN</b>	Enumeration
<b>DEFAULT VALUE</b>	AUTO
<b>EQUIVALENT MENU</b>	<span style="border: 1px solid black; padding: 2px;">SWEEP</span> > Point Trigger
<b>EXAMPLE</b>	<code>:SWEep:POINT:TRIGger:TYPE KEY</code> <code>:SWEep:POINT:TRIGger:TYPE?</code> Return: <code>KEYn</code>

**3.4.5.27 Trigger Slope ([:SOURce]:INPut:TRIGger:SLOPe)**

<b>SYNTAX</b>	<code>[:SOURce]:INPut:TRIGger:SLOPe POSitive NEGative</code> <code>[:SOURce]:INPut:TRIGger:SLOPe?</code>
<b>DESCRIPTION</b>	This command sets/queries the trigger edge of the external trigger signal for the sweep function.
<b>DATA TYPE</b>	Enumeration
<b>RANGE</b>	POSitive NEGative
<b>RETURN</b>	Enumeration
<b>DEFAULT VALUE</b>	POSitive
<b>EQUIVALENT MENU</b>	<span style="border: 1px solid black; padding: 2px;">SWEEP</span> > Trigger Slope

---

**EXAMPLE**                    :*INPut:TRIGger:SLOPe NEGative*  
                                  :*INPut:TRIGger:SLOPe?*  
Return:  
                                  :*NEGative*\n

---

#### 3.4.5.28 Get Current Sweep Point ([:SOURce]:SWEep:CURRent:DATA?)

---

<b>SYNTAX</b>	[:SOURce]:SWEep:CURRent:DATA?
<b>DESCRIPTION</b>	This command queries the current sweep point.
<b>RETURN</b>	String The string format: index,{freq,level,time} Index: interger, Freq: float, unit: Hz, Level: float, unit: dBm, Time: float, unit: s.
<b>DEFAULT VALUE</b>	None
<b>EQUIVALENT MENU</b>	Display frequency and display level at the top of the screen
<b>EXAMPLE</b>	: <i>SWEep:CURRent:DATA?</i> Return: : <i>1,{1000000000,0,0.03}</i> \n

---

#### 3.4.5.29 Get the Frequency of the Current Sweep Point ([:SOURce]:SWEep:CURRent:FREQuency?)

---

<b>SYNTAX</b>	[:SOURce]:SWEep:CURRent:FREQuency?
<b>DESCRIPTION</b>	This command queries the frequency of the current sweep point.
<b>RETURN</b>	Float, unit: Hz
<b>DEFAULT VALUE</b>	None
<b>EQUIVALENT MENU</b>	Display frequency at the top of the screen
<b>EXAMPLE</b>	: <i>SWEep:CURRent:FREQuency?</i> Return: : <i>1000000000.000000</i> \n

---

#### 3.4.5.30 Get the Level of the Current Sweep Point ([:SOURce]:SWEep:CURRent:LEVel?)

---

<b>SYNTAX</b>	[:SOURce]:SWEep:CURRent:LEVel?
<b>DESCRIPTION</b>	This command queries the level of the current sweep point.
<b>RETURN</b>	Float, unit: dBm
<b>DEFAULT VALUE</b>	None
<b>EQUIVALENT MENU</b>	Display level at the top of the screen
<b>EXAMPLE</b>	: <i>SWEep:CURRent:LEVel?</i> Return: : <i>0.000000</i> \n

---

### 3.4.6 Sensor

#### 3.4.6.1 Level Control ([:SOURce]:POWer:SPC:STATe)

<b>SYNTAX</b>	[:SOURce]:POWer:SPC:STATe ON OFF 1 0 [:SOURce]:POWer:SPC:STATe?
<b>DESCRIPTION</b>	This command sets/queries the level control state of the power sensor.
<b>DATA TYPE</b>	Boolean
<b>RANGE</b>	ON OFF 1 0
<b>RETURN</b>	1 0
<b>DEFAULT VALUE</b>	0
<b>EQUIVALENT SCPI</b>	:SENSe[:POWer]:LEV:CTL:STATe ON OFF 1 0 :SENSe[:POWer]:LEV:CTL:STATe?
<b>EQUIVALENT MENU</b>	<b>HOME</b> > POWER SENSOR > Level Control
<b>EXAMPLE</b>	<i>:POWer:SPC:STATe ON</i> <i>:POWer:SPC:STATe?</i> Return: <i>1\n</i>

#### 3.4.6.2 Target Level ([:SOURce]:POWer:SPC:TARGeT)

<b>SYNTAX</b>	[:SOURce]:POWer:SPC:TARGeT <power> [:SOURce]:POWer:SPC:TARGeT?
<b>DESCRIPTION</b>	This command sets/queries the target level of the power sensor level control.
<b>DATA TYPE</b>	Float, unit: dBm, dBuV, uV, mV, V, nW, uW, mW or W, default is dBm
<b>RANGE</b>	-120 dBm ~ 20 dBm
<b>RETURN</b>	Float, unit: dBm
<b>DEFAULT VALUE</b>	0
<b>EQUIVALENT SCPI</b>	:SENSe[:POWer]:SPC:TARGeT <power> :SENSe[:POWer]:SPC:TARGeT?
<b>EQUIVALENT MENU</b>	<b>HOME</b> > POWER SENSOR > Level Control > Target Level
<b>EXAMPLE</b>	<i>:POWer:SPC:TARGeT 0</i> <i>:POWer:SPC:TARGeT?</i> Return: <i>0\n</i>

#### 3.4.6.3 Limit Level ([:SOURce]:POWer:LIMit)

<b>SYNTAX</b>	[:SOURce]:POWer:LIMit <power> [:SOURce]:POWer:LIMit?
<b>DESCRIPTION</b>	This command sets/queries the Limit level of the power sensor level control.
<b>DATA TYPE</b>	Float, unit: dBm, dBuV, uV, mV, V, nW, uW, mW or W, default is dBm

<b>RANGE</b>	-120 dBm ~ 20 dBm
<b>RETURN</b>	Float, unit: dBm
<b>DEFAULT VALUE</b>	0
<b>EQUIVALENT SCPI</b>	:SENSe[:POWer]:LIMit <power> :SENSe[:POWer]:LIMit?
<b>EQUIVALENT MENU</b>	<b>HOME</b> > POWER SENSOR > Level Control > Limit Level
<b>EXAMPLE</b>	<i>POWer:LIMit 1</i> <i>POWer:LIMit?</i> Return: <i>1\n</i>

#### 3.4.6.4 Catch Range ([:SOURce]:POWer:SPC:CRANge)

<b>SYNTAX</b>	[SOURce]:POWer:SPC:CRANge <power> [SOURce]:POWer:SPC:CRANge?
<b>DESCRIPTION</b>	This command sets/queries the catch range of the power sensor level control.
<b>DATA TYPE</b>	Float, unit: dB
<b>RANGE</b>	0 ~ 50
<b>RETURN</b>	Float, unit: dB
<b>DEFAULT VALUE</b>	0
<b>EQUIVALENT SCPI</b>	:SENSe[:POWer]:SPC:CRANge <power> :SENSe[:POWer]:SPC:CRANge?
<b>EQUIVALENT MENU</b>	<b>HOME</b> > POWER SENSOR > Level Control > Catch Range
<b>EXAMPLE</b>	<i>:POWer:SPC:CRANge 5</i> <i>:POWer:SPC:CRANge?</i> Return: <i>5\n</i>

### 3.4.7 Analog Modulation

#### 3.4.7.1 Analog Modulation State ([:SOURce]:MODulation)

<b>SYNTAX</b>	[:SOURce]:MODulation ON OFF 1 0 [:SOURce]:MODulation?
<b>DESCRIPTION</b>	This command sets/gets the switch status of analog modulation.
<b>DATA TYPE</b>	Boolean
<b>RANGE</b>	ON OFF 1 0
<b>RETURN</b>	1 0
<b>DEFAULT VALUE</b>	0
<b>EQUIVALENT SCPI</b>	:OUTPut:MODulation[:STATe] ON OFF 1 0 :OUTPut:MODulation[:STATe]?

<b>EQUIVALENT MENU</b>	ANALOG MOD > On
<b>EXAMPLE</b>	<i>:MODulation ON</i> <i>:MODulation?</i> Return: <i>1\n</i>

### 3.4.7.2 AM

#### 3.4.7.2.1 AM State ([:SOURce]:AM:STATe)

<b>SYNTAX</b>	[:SOURce]:AM:STATe ON OFF 1 0 [:SOURce]:AM:STATe?
<b>DESCRIPTION</b>	This command sets/gets the switch status of amplitude modulation.
<b>DATA TYPE</b>	Boolean
<b>RANGE</b>	ON OFF 1 0
<b>RETURN</b>	1 0
<b>DEFAULT VALUE</b>	0
<b>EQUIVALENT MENU</b>	<span style="border: 1px solid black; padding: 2px;">MOD</span> > AM > AM State
<b>EXAMPLE</b>	<i>:AM:STATe ON</i> <i>:AM:STATe?</i> Return: <i>1\n</i>

#### 3.4.7.2.2 AM Shape ([:SOURce]:AM:WAVEform)

<b>SYNTAX</b>	[:SOURce]:AM:WAVEform SINE SQUAre [:SOURce]:AM:WAVEform?
<b>DESCRIPTION</b>	This command sets/queries the modulation waveform of AM.
<b>DATA TYPE</b>	Enumeration
<b>RANGE</b>	SINE SQUAre
<b>RETURN</b>	Enumeration
<b>DEFAULT VALUE</b>	SINE
<b>EQUIVALENT MENU</b>	<span style="border: 1px solid black; padding: 2px;">MOD</span> > AM > AM Shape
<b>EXAMPLE</b>	<i>:AM:WAVEform SQUAre</i> <i>:AM:WAVEform?</i> Return: <i>SQUAre\n</i>

#### 3.4.7.2.3 AM Source ([:SOURce]:AM:SOURce)

<b>SYNTAX</b>	[:SOURce]:AM:SOURce INTernal EXTernal INT,EXT [:SOURce]:AM:SOURce?
<b>DESCRIPTION</b>	This command sets/queries the modulation source of AM.

<b>DATA TYPE</b>	Enumeration
<b>RANGE</b>	INTernal EXTernal INT,EXT
<b>RETURN</b>	Enumeration
<b>DEFAULT VALUE</b>	INTernal
<b>EQUIVALENT MENU</b>	<b>MOD</b> > AM > AM Source
<b>EXAMPLE</b>	<i>:AM:SOURce EXTernal</i> <i>:AM:SOURce?</i> Return: <i>EXTernal</i>

#### 3.4.7.2.4 AM Depth ([:SOURce]:AM:DEPT<sub>h</sub>)

<b>SYNTAX</b>	<i>[:SOURce]:AM:DEPT<sub>h</sub> &lt;value&gt;</i> <i>[:SOURce]:AM:DEPT<sub>h</sub>?</i>
<b>DESCRIPTION</b>	This command sets/queries the modulation depth of AM.
<b>DATA TYPE</b>	Float
<b>RANGE</b>	0 ~ 1
<b>RETURN</b>	Float
<b>DEFAULT VALUE</b>	0.5
<b>EQUIVALENT MENU</b>	<b>MOD</b> > AM > AM Depth
<b>EXAMPLE</b>	<i>:AM:DEPT<sub>h</sub> 0.2</i> <i>:AM:DEPT<sub>h</sub>?</i> Return: <i>0.2</i>

#### 3.4.7.2.5 AM Rate ([:SOURce]:AM:FREQuency)

<b>SYNTAX</b>	<i>[:SOURce]:AM:FREQuency &lt;value&gt;</i> <i>[:SOURce]:AM:FREQuency?</i>
<b>DESCRIPTION</b>	This command sets/queries the modulation rate of AM.
<b>DATA TYPE</b>	Float, unit: Hz, kHz, MHz or GHz, default is Hz
<b>RANGE</b>	Modulation wave is Sine: 0.01 Hz ~ 100 kHz, Modulation wave is Square: 0.01 Hz ~ 20 kHz.
<b>RETURN</b>	Float, unit: Hz
<b>DEFAULT VALUE</b>	1 kHz
<b>EQUIVALENT MENU</b>	<b>MOD</b> > AM > AM Rate
<b>EXAMPLE</b>	<i>:AM:FREQuency 10 kHz</i> <i>:AM:FREQuency?</i> Return: <i>10000</i>

**3.4.7.2.6 AM Sensitivity ([:SOURce]:AM:SENSitivity?)**

<b>SYNTAX</b>	[:SOURce]:AM:SENSitivity?
<b>DESCRIPTION</b>	This command queries the sensitivity of AM external modulation.
<b>RETURN</b>	Float, unit: /V
<b>DEFAULT VALUE</b>	0.125/V
<b>EQUIVALENT MENU</b>	<b>MOD</b> > AM > AM Sensitivity
<b>EXAMPLE</b>	<i>AM:SENSitivity?</i> Return: <i>0.125\n</i>

**3.4.7.3 FM****3.4.7.3.1 FM State ([:SOURce]:FM:STATE)**

<b>SYNTAX</b>	[:SOURce]:FM:STATe ON OFF 1 0 [:SOURce]:FM:STATe?
<b>DESCRIPTION</b>	This command sets/gets the switch status of frequency modulation.
<b>DATA TYPE</b>	Boolean
<b>RANGE</b>	ON OFF 1 0
<b>RETURN</b>	1 0
<b>DEFAULT VALUE</b>	0
<b>EQUIVALENT MENU</b>	<b>MOD</b> > FM > FM State
<b>EXAMPLE</b>	<i>:FM:STATe ON</i> <i>:FM:STATe?</i> Return: <i>1\n</i>

**3.4.7.3.2 FM Source ([:SOURce]:FM:SOURce)**

<b>SYNTAX</b>	[:SOURce]:FM:SOURce INT1 INT2 INT1,INT2 EXTernal INT1,EXT DUAL [:SOURce]:FM:SOURce?
<b>DESCRIPTION</b>	This command sets/queries the modulation source of FM.
<b>DATA TYPE</b>	Enumeration
<b>RANGE</b>	INT1 INT2 INT1,INT2 EXTernal INT1,EXT DUAL
<b>RETURN</b>	Enumeration
<b>DEFAULT VALUE</b>	INT1
<b>EQUIVALENT MENU</b>	<b>MOD</b> > FM > FM Source
<b>EXAMPLE</b>	<i>:FM:SOURce EXTernal</i> <i>:FM:SOURce?</i> Return: <i>EXTernal\n</i>

**3.4.7.3.3 FM Shape1 ([:SOURce]:FM1:WAVEform)**

<b>SYNTAX</b>	<code>[:SOURce]:FM1:WAVEform SINE SQUAre SAWTooth TRIangle</code> <code>[:SOURce]:FM1:WAVEform?</code>
<b>DESCRIPTION</b>	This command sets/queries the frequency modulation waveform of INT1 modulation source.
<b>DATA TYPE</b>	Enumeration
<b>RANGE</b>	SINE SQUAre SAWTooth TRIangle
<b>RETURN</b>	Enumeration
<b>DEFAULT VALUE</b>	SINE
<b>EQUIVALENT MENU</b>	<span style="border: 1px solid black; padding: 2px;">MOD</span> > FM > FM Shape1
<b>EXAMPLE</b>	<code>:FM1:WAVEform SQUAre</code> <code>:FM1:WAVEform?</code> Return: <code>SQUAre\n</code>

**3.4.7.3.4 FM Deviation1 ([:SOURce]:FM1:DEVIation)**

<b>SYNTAX</b>	<code>[:SOURce]:FM1:DEVIation &lt;value&gt;</code> <code>[:SOURce]:FM1:DEVIation?</code>
<b>DESCRIPTION</b>	This command sets/queries the deviation value of the FM waveform of the INT1 modulation source.
<b>DATA TYPE</b>	Float, unit: Hz, kHz, MHz or GHz, default is Hz
<b>RANGE</b>	1 Hz ~ N*1 MHz, N is the frequency segment coefficient, please refer to the data sheet
<b>RETURN</b>	Float, unit: Hz
<b>DEFAULT VALUE</b>	100 kHz
<b>EQUIVALENT MENU</b>	<span style="border: 1px solid black; padding: 2px;">MOD</span> > FM > FM Deviation1
<b>EXAMPLE</b>	<code>:FM1:DEVIation 200 kHz</code> <code>:FM1:DEVIation?</code> Return: <code>200000\n</code>

**3.4.7.3.5 FM Rate1 ([:SOURce]:FM1:FREQuency)**

<b>SYNTAX</b>	<code>[:SOURce]:FM1:FREQuency &lt;value&gt;</code> <code>[:SOURce]:FM1:FREQuency?</code>
<b>DESCRIPTION</b>	This command sets/queries the FM rate of the INT1 modulation source.
<b>DATA TYPE</b>	Float, unit: Hz, kHz, MHz or GHz, default is Hz
<b>RANGE</b>	Modulation wave is Sine: 0.01 Hz ~ 100 kHz, Modulation wave is Square/Sawtooth/Triangle: 0.01 Hz ~ 20 kHz.
<b>RETURN</b>	Float, unit: Hz



<b>DEFAULT VALUE</b>	10 kHz
<b>EQUIVALENT MENU</b>	<b>MOD</b> > FM > FM Rate1
<b>EXAMPLE</b>	<i>:FM1:FREQuency 5 kHz</i> <i>:FM1:FREQuency?</i> Return: <i>5000\n</i>

#### 3.4.7.3.6 FM Phase1 ([:SOURce]:FM1:PHASe)

<b>SYNTAX</b>	[:SOURce]:FM1:PHASe <value> [:SOURce]:FM1:PHASe?
<b>DESCRIPTION</b>	When the frequency modulation source is internal source 1 + internal source 2 (Int1 + Int2) or Dual waveform, this command sets/queries the initial phase of internal source 1.
<b>DATA TYPE</b>	Float, unit: degree (°)
<b>RANGE</b>	-360 ~ +360
<b>RETURN</b>	Float, unit: degree (°)
<b>DEFAULT VALUE</b>	0
<b>EQUIVALENT MENU</b>	<b>MOD</b> > FM > FM Phase1
<b>EXAMPLE</b>	<i>:FM1:PHASe -30</i> <i>:FM1:PHASe?</i> Return: <i>-30\n</i>

#### 3.4.7.3.7 FM Shape2 ([:SOURce]:FM2:WAVEform)

<b>SYNTAX</b>	[:SOURce]:FM2:WAVEform SINE SQUAre SAWTooth TRlangle [:SOURce]:FM2:WAVEform?
<b>DESCRIPTION</b>	This command sets/queries the frequency modulation waveform of INT2 modulation source.
<b>DATA TYPE</b>	Enumeration
<b>RANGE</b>	SINE SQUAre SAWTooth TRlangle
<b>RETURN</b>	Enumeration
<b>DEFAULT VALUE</b>	SINE
<b>EQUIVALENT MENU</b>	<b>MOD</b> > FM > FM Shape2
<b>EXAMPLE</b>	<i>:FM2:WAVEform TRlangle</i> <i>:FM2:WAVEform?</i> Return: <i>TRlangle\n</i>

#### 3.4.7.3.8 FM Deviation2 ([:SOURce]:FM2:DEVIation)

<b>SYNTAX</b>	[:SOURce]:FM2:DEVIation <value> [:SOURce]:FM2:DEVIation?
---------------	---

<b>DESCRIPTION</b>	This command sets/queries the deviation value of the FM waveform of the INT2 modulation source.
<b>DATA TYPE</b>	Float, unit: Hz, kHz, MHz or GHz, default is Hz
<b>RANGE</b>	1 Hz ~ N*1 MHz, N is the frequency segment coefficient, please refer to the data sheet
<b>RETURN</b>	Float, unit: Hz
<b>DEFAULT VALUE</b>	100 kHz
<b>EQUIVALENT MENU</b>	<input type="text" value="MOD"/> > FM > FM Deviation2
<b>EXAMPLE</b>	<i>:FM2:DEVIation 200 kHz</i> <i>:FM2:DEVIation?</i> Return: <i>200000\n</i>

#### 3.4.7.3.9 FM Rate2 ([:SOURce]:FM2:FREQuency)

<b>SYNTAX</b>	<i>[:SOURce]:FM2:FREQuency &lt;value&gt;</i> <i>[:SOURce]:FM2:FREQuency?</i>
<b>DESCRIPTION</b>	This command sets/queries the FM rate of the INT2 modulation source.
<b>DATA TYPE</b>	Float, unit: Hz, kHz, MHz or GHz, default is Hz
<b>RANGE</b>	Modulation wave is Sine: 0.01 Hz ~ 100 kHz, Modulation wave is Square/Sawtooth/Triangle: 0.01 Hz ~ 20 kHz.
<b>RETURN</b>	Float, unit: Hz
<b>DEFAULT VALUE</b>	10 kHz
<b>EQUIVALENT MENU</b>	<input type="text" value="MOD"/> > FM > FM Rate2
<b>EXAMPLE</b>	<i>:FM2:FREQuency 40 kHz</i> <i>:FM2:FREQuency?</i> Return: <i>40000\n</i>

#### 3.4.7.3.10 FM Phase2 ([:SOURce]:FM2:PHASe)

<b>SYNTAX</b>	<i>[:SOURce]:FM2:PHASe &lt;value&gt;</i> <i>[:SOURce]:FM2:PHASe?</i>
<b>DESCRIPTION</b>	When the frequency modulation source is internal source 1 + internal source 2 (Int1 + Int2) or Dual waveform, this command sets/queries the initial phase of internal source 2.
<b>DATA TYPE</b>	Float, unit: degree (°)
<b>RANGE</b>	-360 ~ +360
<b>RETURN</b>	Float, unit: degree (°)
<b>DEFAULT VALUE</b>	0
<b>EQUIVALENT MENU</b>	<input type="text" value="MOD"/> > FM > FM Phase2

---

**EXAMPLE**                    :*FM2:PHASe -30*  
                                   :*FM2:PHASe?*  
 Return:  
                                   :*-30\n*

---

#### 3.4.7.3.11 Int1 Proportion ([:SOURce]:FM1:PROPortion)

---

<b>SYNTAX</b>	[:SOURce]:FM1:PROPortion <value> [:SOURce]:FM1:PROPortion?
<b>DESCRIPTION</b>	This command sets/queries the proportion of waveform1 when the FM Source is Dual.
<b>DATA TYPE</b>	Float
<b>RANGE</b>	0 ~ 1
<b>RETURN</b>	Float
<b>DEFAULT VALUE</b>	0.5
<b>EQUIVALENT MENU</b>	<input type="text" value="MOD"/> > FM > Int1 Proportion
<b>EXAMPLE</b>	: <i>FM1:PROPortion 0.6</i> : <i>FM1:PROPortion?</i> Return: : <i>0.6\n</i>

---

#### 3.4.7.3.12 FM Sensitivity1 ([:SOURce]:FM1:SENSitivity?)

---

<b>SYNTAX</b>	[:SOURce]:FM1:SENSitivity?
<b>DESCRIPTION</b>	When the frequency modulation source includes an external source, this command queries the sensitivity of the external source input.
<b>RETURN</b>	Float, unit: Hz/V
<b>DEFAULT VALUE</b>	None
<b>EQUIVALENT MENU</b>	<input type="text" value="MOD"/> > FM > FM Sensitivity1
<b>EXAMPLE</b>	: <i>FM1:SENSitivity?</i> Return: : <i>125000\n</i>

---

### 3.4.7.4 PM

#### 3.4.7.4.1 PM State ([:SOURce]:PM:STATe)

---

<b>SYNTAX</b>	[:SOURce]:PM:STATe ON OFF 1 0 [:SOURce]:PM:STATe?
<b>DESCRIPTION</b>	This command sets/gets the switch status of phase modulation.
<b>DATA TYPE</b>	Boolean
<b>RANGE</b>	ON OFF 1 0
<b>RETURN</b>	1 0

---

<b>DEFAULT VALUE</b>	0
<b>EQUIVALENT MENU</b>	<b>MOD</b> > PM > PM State
<b>EXAMPLE</b>	<i>:PM:STATe ON</i> <i>:PM:STATe?</i> Return: <i>1</i>

#### 3.4.7.4.2 PM Shape ([:SOURce]:PM:WAVEform)

<b>SYNTAX</b>	<i>[:SOURce]:PM:WAVEform SINE SQUAre</i> <i>[:SOURce]:PM:WAVEform?</i>
<b>DESCRIPTION</b>	This command sets/queries the modulation waveform of PM.
<b>DATA TYPE</b>	Enumeration
<b>RANGE</b>	SINE SQUAre
<b>RETURN</b>	Enumeration
<b>DEFAULT VALUE</b>	SINE
<b>EQUIVALENT MENU</b>	<b>MOD</b> > PM > PM Shape
<b>EXAMPLE</b>	<i>:PM:WAVEform SQUAre</i> <i>:PM:WAVEform?</i> Return: <i>SQUAre</i>

#### 3.4.7.4.3 PM Source ([:SOURce]:PM:SOURce)

<b>SYNTAX</b>	<i>[:SOURce]:PM:SOURce INTernal EXTernal INT,EXT</i> <i>[:SOURce]:PM:SOURce?</i>
<b>DESCRIPTION</b>	This command sets/queries the modulation source of PM.
<b>DATA TYPE</b>	Enumeration
<b>RANGE</b>	INTernal EXTernal INT,EXT
<b>RETURN</b>	Enumeration
<b>DEFAULT VALUE</b>	INTernal
<b>EQUIVALENT MENU</b>	<b>MOD</b> > PM > PM Source
<b>EXAMPLE</b>	<i>:PM:SOURce EXTernal</i> <i>:PM:SOURce?</i> Return: <i>EXTernal</i>

#### 3.4.7.4.4 PM Deviation ([:SOURce]:PM:DEVIation)

<b>SYNTAX</b>	<i>[:SOURce]:PM:DEVIation &lt;value&gt;</i> <i>[:SOURce]:PM:DEVIation?</i>
<b>DESCRIPTION</b>	This command sets/queries the modulation deviation of the phase modulation.

<b>DATA TYPE</b>	Float, unit: rad
<b>RANGE</b>	0.01 rad ~ N*5 rad, N is the frequency segment coefficient, please refer to the data sheet
<b>RETURN</b>	Float, unit: rad
<b>DEFAULT VALUE</b>	1
<b>EQUIVALENT MENU</b>	<b>MOD</b> > PM > PM Deviation
<b>EXAMPLE</b>	<i>:PM:DEVIation 2</i> <i>:PM:DEVIation?</i> Return: <i>2</i>

#### 3.4.7.4.5 PM Rate ([:SOURce]:PM:FREQuency)

<b>SYNTAX</b>	<i>[:SOURce]:PM:FREQuency &lt;value&gt;</i> <i>[:SOURce]:PM:FREQuency?</i>
<b>DESCRIPTION</b>	This command sets/queries the modulation rate of PM.
<b>DATA TYPE</b>	Float, unit: Hz, kHz, MHz or GHz, default is Hz
<b>RANGE</b>	Modulation wave is Sine: 0.01 Hz ~ 100 kHz, Modulation wave is Square: 0.01 Hz ~ 20 kHz.
<b>RETURN</b>	Float, unit: Hz
<b>DEFAULT VALUE</b>	10 kHz
<b>EQUIVALENT MENU</b>	<b>MOD</b> > PM > PM Rate
<b>EXAMPLE</b>	<i>:PM:FREQuency 1 kHz</i> <i>:PM:FREQuency?</i> Return: <i>1000</i>

#### 3.4.7.4.6 PM Sensitivity ([:SOURce]:PM:SENSitivity?)

<b>SYNTAX</b>	<i>[:SOURce]:PM:SENSitivity?</i>
<b>DESCRIPTION</b>	This command queries the sensitivity of PM external modulation.
<b>RETURN</b>	Float, unit: rad/V
<b>DEFAULT VALUE</b>	None
<b>EQUIVALENT MENU</b>	<b>MOD</b> > PM > PM Sensitivity
<b>EXAMPLE</b>	<i>PM:SENSitivity?</i> Return: <i>0.25</i>

### 3.4.8 Pulse Modulation

#### 3.4.8.1 Pulse State ([:SOURce]:PULM:STATe)

<b>SYNTAX</b>	[:SOURce]:PULM:STATe ON OFF 1 0 [:SOURce]:PULM:STATe?
<b>DESCRIPTION</b>	This command sets/gets the switch status of pulse modulation.
<b>DATA TYPE</b>	Boolean
<b>RANGE</b>	ON OFF 1 0
<b>RETURN</b>	1 0
<b>DEFAULT VALUE</b>	0
<b>EQUIVALENT MENU</b>	<span style="border: 1px solid black; padding: 2px;">MOD</span> > PULSE > Pulse State
<b>EXAMPLE</b>	<i>:PULM:STATe ON</i> <i>:PULM:STATe?</i> Return: <i>1</i>

#### 3.4.8.2 Pulse Source ([:SOURce]:PULM:SOURce)

<b>SYNTAX</b>	[:SOURce]:PULM:SOURce INTernal EXTernal [:SOURce]:PULM:SOURce?
<b>DESCRIPTION</b>	This command sets/queries the modulation source of pulse modulation.
<b>DATA TYPE</b>	Enumeration
<b>RANGE</b>	INTernal EXTernal
<b>RETURN</b>	Enumeration
<b>DEFAULT VALUE</b>	INTernal
<b>EQUIVALENT SCPI</b>	[:SOURce]:PULM:SOURce:INT INTernal EXTernal [:SOURce]:PULM:SOURce:INT?
<b>EQUIVALENT MENU</b>	<span style="border: 1px solid black; padding: 2px;">MOD</span> > PULSE > Pulse Source
<b>EXAMPLE</b>	<i>:PULM:SOURce INTernal</i> <i>:PULM:SOURce?</i> Return: <i>INTernal</i>

#### 3.4.8.3 Pulse Source ([:SOURce]:PULM:SOURce:INT)

<b>SYNTAX</b>	[:SOURce]:PULM:SOURce:INT INTernal EXTernal [:SOURce]:PULM:SOURce:INT?
<b>DESCRIPTION</b>	This command sets/queries the modulation source of pulse modulation.
<b>DATA TYPE</b>	Enumeration
<b>RANGE</b>	INTernal EXTernal

<b>RETURN</b>	Enumeration
<b>DEFAULT VALUE</b>	INTernal
<b>EQUIVALENT SCPI</b>	[[:SOURce]:PULM:SOURce INTernal EXTernal [:SOURce]:PULM:SOURce?
<b>EQUIVALENT MENU</b>	<b>MOD</b> > PULSE > Pulse Source
<b>EXAMPLE</b>	<i>:PULM:SOURce:INT EXTernal</i> <i>:PULM:SOURce:INT?</i> Return: <i>EXTernal</i>

#### 3.4.8.4 Pulse Out ([[:SOURce]:PULM:OUT:STATe])

<b>SYNTAX</b>	[[:SOURce]:PULM:OUT:STATe ON OFF]1 0 [:SOURce]:PULM:OUT:STATe?
<b>DESCRIPTION</b>	This command sets/queries the pulse output status of pulse modulation.
<b>DATA TYPE</b>	Boolean
<b>RANGE</b>	ON OFF]1 0
<b>RETURN</b>	1 0
<b>DEFAULT VALUE</b>	0
<b>EQUIVALENT MENU</b>	<b>MOD</b> > PULSE > Pulse Out
<b>EXAMPLE</b>	<i>:PULM:OUT:STATe ON</i> <i>:PULM:OUT:STATe?</i> Return: <i>1</i>

#### 3.4.8.5 Pulse Out Polarity ([[:SOURce]:PULM:POLarity])

<b>SYNTAX</b>	[[:SOURce]:PULM:POLarity NORMal INVerted [:SOURce]:PULM:POLarity?
<b>DESCRIPTION</b>	This command sets/queries the pulse output polarity.
<b>DATA TYPE</b>	Enumeration
<b>RANGE</b>	NORMal INVerted
<b>RETURN</b>	Enumeration
<b>DEFAULT VALUE</b>	NORMal
<b>EQUIVALENT MENU</b>	<b>MOD</b> > PULSE > Pulse Out Polarity
<b>EXAMPLE</b>	<i>:PULM:POL INV</i> <i>:PULM:POLarity?</i> Return: <i>INVerted</i>

**3.4.8.6 Pulse Mode ([:SOURce]:PULM:MODE)**

<b>SYNTAX</b>	<code>[:SOURce]:PULM:MODE SINGle DOUBle PTRain</code> <code>[:SOURce]:PULM:MODE?</code>
<b>DESCRIPTION</b>	This command sets the pulse mode to Single pulse, Double pulse or pulse Train. This command queries the pulse mode.
<b>DATA TYPE</b>	Enumeration
<b>RANGE</b>	SINGle DOUBle PTRain
<b>RETURN</b>	Enumeration
<b>DEFAULT VALUE</b>	SINGle
<b>EQUIVALENT MENU</b>	<span style="border: 1px solid black; padding: 2px;">MOD</span> > PULSE > Pulse Mode
<b>EXAMPLE</b>	<i>PULM:MODE DOUB</i> <i>PULM:MODE?</i> Return: <i>DOUBle</i>

**3.4.8.7 Pulse Period ([:SOURce]:PULM:PERiod)**

<b>SYNTAX</b>	<code>[:SOURce]:PULM:PERiod &lt;value&gt;</code> <code>[:SOURce]:PULM:PERiod?</code>
<b>DESCRIPTION</b>	When the pulse mode is Single or Double, this command sets/queries the pulse period.
<b>DATA TYPE</b>	Float, unit: ns, us, ms or s, default is s
<b>RANGE</b>	40 ns ~ 300 s
<b>RETURN</b>	Float, unit: s
<b>DEFAULT VALUE</b>	10 ms
<b>EQUIVALENT SCPI</b>	<code>[:SOURce]:PULM:INT[1]:PERiod &lt;value&gt;</code> <code>[:SOURce]:PULM:INT[1]:PERiod?</code>
<b>EQUIVALENT MENU</b>	<span style="border: 1px solid black; padding: 2px;">MOD</span> > PULSE > Pulse Period
<b>EXAMPLE</b>	<i>PULM:PER 220 us</i> <i>PULM:PER?</i> Return: <i>0.00022</i>

**3.4.8.8 Pulse Period ([:SOURce]:PULM:INT[1]:PERiod)**

<b>SYNTAX</b>	<code>[:SOURce]:PULM:INT[1]:PERiod &lt;value&gt;</code> <code>[:SOURce]:PULM:INT[1]:PERiod?</code>
<b>DESCRIPTION</b>	When the pulse mode is Single or Double, this command sets/queries the pulse period.
<b>DATA TYPE</b>	Float, unit: ns, us, ms or s, default is s
<b>RANGE</b>	40 ns ~ 300 s



<b>RETURN</b>	Float, unit: s
<b>DEFAULT VALUE</b>	10 ms
<b>EQUIVALENT SCPI</b>	[[:SOURce]:PULM:PERiod <value> [:SOURce]:PULM:PERiod?
<b>EQUIVALENT MENU</b>	<b>MOD</b> > PULSE > Pulse Period
<b>EXAMPLE</b>	<i>:PULM:INT1:PERiod 900 ns</i> <i>:PULM:INT1:PERiod?</i> Return: <i>9e-07n</i>

#### 3.4.8.9 Pulse Width ([[:SOURce]:PULM:WIDTH])

<b>SYNTAX</b>	[[:SOURce]:PULM:WIDTH <value> [:SOURce]:PULM:WIDTH?
<b>DESCRIPTION</b>	When the pulse mode is Single, this command sets/queries the pulse width; when the pulse mode is Double, this command sets/queries the pulse width of the first pulse.
<b>DATA TYPE</b>	Float, unit: ns, us, ms or s, default is s
<b>RANGE</b>	20 ns ~ 300 s
<b>RETURN</b>	Float, unit: s
<b>DEFAULT VALUE</b>	2 ms
<b>EQUIVALENT SCPI</b>	[[:SOURce]:PULM:INT[1]:PWIDth <value> [:SOURce]:PULM:INT[1]:PWIDth?
<b>EQUIVALENT MENU</b>	<b>MOD</b> > PULSE > Pulse Width
<b>EXAMPLE</b>	<i>PULM:WIDT 33 us</i> <i>PULM:WIDT?</i> Return: <i>3.3e-05n</i>

#### 3.4.8.10 Pulse Width ([[:SOURce]:PULM:INT[1]:PWIDth])

<b>SYNTAX</b>	[[:SOURce]:PULM:INT[1]:PWIDth <value> [:SOURce]:PULM:INT[1]:PWIDth?
<b>DESCRIPTION</b>	When the pulse mode is Single, this command sets/queries the pulse width; when the pulse mode is Double, this command sets/queries the pulse width of the first pulse.
<b>DATA TYPE</b>	Float, unit: ns, us, ms or s, default is s
<b>RANGE</b>	20 ns ~ 300 s
<b>RETURN</b>	Float, unit: s
<b>DEFAULT VALUE</b>	2 ms
<b>EQUIVALENT SCPI</b>	[[:SOURce]:PULM:WIDTH <value> [:SOURce]:PULM:WIDTH?
<b>EQUIVALENT MENU</b>	<b>MOD</b> > PULSE > Pulse Width

---

**EXAMPLE**                    :*PULM:INT:PWIDth 400 ns*  
                                   :*PULM:INT:PWIDth?*  
 Return:  
                                   4e-07\n

---

#### 3.4.8.11 Double Pulse Delay ([:SOURce]:PULM:DOUBle:DELay)

---

<b>SYNTAX</b>	[:SOURce]:PULM:DOUBle:DELay <value> [:SOURce]:PULM:DOUBle:DELay?
<b>DESCRIPTION</b>	When the pulse mode is Double, this command sets/queries the double pulse delay.
<b>DATA TYPE</b>	Float, unit: ns, us, ms or s, default is s
<b>RANGE</b>	20 ns ~ 300 s
<b>RETURN</b>	Float, unit: s
<b>DEFAULT VALUE</b>	4 ms
<b>EQUIVALENT MENU</b>	<span style="border: 1px solid black; padding: 2px;">MOD</span> > PULSE > Double Pulse Delay
<b>EXAMPLE</b>	<i>:PULM:DOUBle:DELay 2 ms</i> <i>:PULM:DOUBle:DELay?</i> Return: 0.002\n

---

#### 3.4.8.12 #2 Width ([:SOURce]:PULM:DOUBle:WIDTh)

---

<b>SYNTAX</b>	[:SOURce]:PULM:DOUBle:WIDTh <time> [:SOURce]:PULM:DOUBle:WIDTh?
<b>DESCRIPTION</b>	When the pulse mode is Double, this command sets/queries the pulse width of the second pulse.
<b>DATA TYPE</b>	Float, unit: ns, us, ms or s, default is s
<b>RANGE</b>	20 ns ~ 300 s
<b>RETURN</b>	Float, unit: s
<b>DEFAULT VALUE</b>	2 ms
<b>EQUIVALENT MENU</b>	<span style="border: 1px solid black; padding: 2px;">MOD</span> > PULSE > #2 Width
<b>EXAMPLE</b>	<i>PULM:DOUBle:WIDTh 5 ms</i> <i>PULM:DOUBle:WIDTh?</i> Return: 0.005\n

---

#### 3.4.8.13 Pulse Train Add Row ([:SOURce]:PULM:TRAI:n:PAIR)

---

<b>SYNTAX</b>	[:SOURce]:PULM:TRAI:n:PAIR <row>
<b>DESCRIPTION</b>	This command copies the specified line of the pulse train and pastes it in front of the specified line.
<b>DATA TYPE</b>	Integer

---

<b>RANGE</b>	1 ~ total number of rows in the pulse train
<b>EQUIVALENT MENU</b>	<input type="text" value="MOD"/> > PULSE > Pulse Train > Add
<b>EXAMPLE</b>	<i>PULM:TRAI:PAIR 1</i>

#### 3.4.8.14 Pulse Train Delete Row ([:SOURce]:PULM:TRAI:DELeTe)

<b>SYNTAX</b>	[:SOURce]:PULM:TRAI:DELeTe <row>
<b>DESCRIPTION</b>	This command removes a specified row from the pulse train.
<b>DATA TYPE</b>	Integer
<b>RANGE</b>	1 ~ total number of rows in the pulse train
<b>EQUIVALENT MENU</b>	<input type="text" value="MOD"/> > PULSE > Pulse Train > Delete
<b>EXAMPLE</b>	<i>PULM:TRAI:DELeTe 5</i>

#### 3.4.8.15 Pulse Train Edit On Time ([:SOURce]:PULM:TRAI:DATA:ONTIme)

<b>SYNTAX</b>	[:SOURce]:PULM:TRAI:DATA:ONTIme <raw>,<on_time>
<b>DESCRIPTION</b>	This command edits the positive pulse width of the specified row in the pulse train.
<b>DATA TYPE</b>	Row: Integer, On_time: float, unit: ns, us, ms or s, default is s
<b>RANGE</b>	Row: 1 ~ total number of rows in the pulse train, On_time: 20 ns ~ 300 s
<b>EQUIVALENT MENU</b>	<input type="text" value="MOD"/> > PULSE > Pulse Train
<b>EXAMPLE</b>	<i>:PULM:TRAI:DATA:ONTIme 1,10 ms</i>

#### 3.4.8.16 Pulse Train Edit Off Time ([:SOURce]:PULM:TRAI:DATA:OFFTime)

<b>SYNTAX</b>	[:SOURce]:PULM:TRAI:DATA:OFFTime <raw>,<off_time>
<b>DESCRIPTION</b>	This command edits the negative pulse width of the specified row in the pulse train.
<b>DATA TYPE</b>	Row: Integer, Off_time: float, unit: ns, us, ms or s, default is s
<b>RANGE</b>	Row: 1 ~ total number of rows in the pulse train, Off_time: 20 ns ~ 300 s
<b>EQUIVALENT MENU</b>	<input type="text" value="MOD"/> > PULSE > Pulse Train
<b>EXAMPLE</b>	<i>:PULM:TRAI:DATA:OFFTime 1, 20 ms</i>

#### 3.4.8.17 Pulse Train Edit Count ([:SOURce]:PULM:TRAI:DATA:COUNT)

<b>SYNTAX</b>	[:SOURce]:PULM:TRAI:DATA:COUNT <raw>,<count>
---------------	--

<b>DESCRIPTION</b>	This command edits the number of repetitions for a specified row of the pulse train.
<b>DATA TYPE</b>	Row: integer, Count: integer
<b>RANGE</b>	Row: 1 ~ total number of rows in the pulse train, Count: 1 ~ 65535
<b>EQUIVALENT MENU</b>	<span style="border: 1px solid black; padding: 2px;">MOD</span> > PULSE > Pulse Train
<b>EXAMPLE</b>	<i>:PULM:TRAI:DATA:COUNT 1,3</i>

#### 3.4.8.18 Pulse Train Edit ([:SOURce]:PULM:TRAI:CHANGE)

<b>SYNTAX</b>	[:SOURce]:PULM:TRAI:CHANGE <row>,<on_time>,<off_time>,<count>
<b>DESCRIPTION</b>	This command edits the specified row of the pulse train.
<b>DATA TYPE</b>	Row: integer, On_time: float, unit: ns, us, ms or s, default is s, Off_time: float, unit: ns, us, ms or s, default is s, Count: integer
<b>RANGE</b>	Row: 1 ~ total number of rows in the pulse train, On_time: 20 ns ~ 300 s, Off_time: 20 ns ~ 300 s, Count: 1 ~ 65535
<b>EQUIVALENT MENU</b>	<span style="border: 1px solid black; padding: 2px;">MOD</span> > PULSE > Pulse Train
<b>EXAMPLE</b>	<i>:PULM:TRAI:CHANGE 2,3 ms,500 ns,4</i>

#### 3.4.8.19 Pulse Train Data ([:SOURce]:PULM:TRAI:LIST?)

<b>SYNTAX</b>	[:SOURce]:PULM:TRAI:LIST? <begin_row>,<end_row>
<b>DESCRIPTION</b>	This command queries the data from begin_row to end_row in the pulse train.
<b>DATA TYPE</b>	Integer, Integer
<b>RANGE</b>	1 ~ total number of rows in the pulse train, Start row ~ total number of rows in the pulse train
<b>RETURN</b>	String
<b>DEFAULT VALUE</b>	None
<b>EQUIVALENT MENU</b>	<span style="border: 1px solid black; padding: 2px;">MOD</span> > PULSE > Pulse Train
<b>EXAMPLE</b>	<i>:PULM:TRAI:LIST? 1,3</i> Return: <i>0.001,0.005,1 0.003,0.003,2 0.004,0.002,1</i>

#### 3.4.8.20 Pulse Train Count ([:SOURce]:PULM:TRAI:COUNT?)

<b>SYNTAX</b>	[:SOURce]:PULM:TRAI:COUNT?
---------------	----------------------------

<b>DESCRIPTION</b>	This command queries the number of rows in the pulse train.
<b>RETURN</b>	String
<b>DEFAULT VALUE</b>	None
<b>EQUIVALENT MENU</b>	<b>MOD</b> > PULSE > Pulse Train
<b>EXAMPLE</b>	<i>:PULM:TRAI:n:COUNt?</i> Return: <i>5\n</i>

#### 3.4.8.21 Pulse Train Clear ([:SOURce]:PULM:TRAI:n:CLEAR)

<b>SYNTAX</b>	<i>[:SOURce]:PULM:TRAI:n:CLEAR</i>
<b>DESCRIPTION</b>	This command clears the pulse train and restores its default value.
<b>EQUIVALENT MENU</b>	<b>MOD</b> > PULSE > Pulse Train > Clear
<b>EXAMPLE</b>	<i>PULM:TRAI:n:CLEAR</i>

#### 3.4.8.22 Pulse Train Load ([:SOURce]:PULM:TRAI:n:LOAD)

<b>SYNTAX</b>	<i>[:SOURce]:PULM:TRAI:n:LOAD &lt;"file_name"&gt;</i>
<b>DESCRIPTION</b>	This command loads the pulse train from a PULSTRN file.
<b>DATA TYPE</b>	String
<b>RANGE</b>	None
<b>EQUIVALENT MENU</b>	<b>MOD</b> > PULSE > Pulse Train > Load
<b>EXAMPLE</b>	<i>PULM:TRAI:n:LOAD "U-disk3/test.pulstrn"</i>

#### 3.4.8.23 Pulse Train Store ([:SOURce]:PULM:TRAI:n:STORE)

<b>SYNTAX</b>	<i>[:SOURce]:PULM:TRAI:n:STORE &lt;"file_name"&gt;</i>
<b>DESCRIPTION</b>	This command saves the pulse train into a PULSTRN file.
<b>DATA TYPE</b>	String
<b>RANGE</b>	None
<b>EQUIVALENT MENU</b>	<b>MOD</b> > PULSE > Pulse Train > Save
<b>EXAMPLE</b>	<i>PULM:TRAI:n:STORE "test.pulstrn"</i> <i>PULM:TRAI:n:STORE "U-disk1/test.pulstrn"</i>

#### 3.4.8.24 Trigger Out ([:SOURce]:PULM:TRIGger:STATe)

<b>SYNTAX</b>	<i>[:SOURce]:PULM:TRIGger:STATe ON OFF 1 0</i> <i>[:SOURce]:PULM:TRIGger:STATe?</i>
<b>DESCRIPTION</b>	This command sets/gets the pulse trigger output status.

<b>DATA TYPE</b>	Boolean
<b>RANGE</b>	ON OFF 1 0
<b>RETURN</b>	1 0
<b>DEFAULT VALUE</b>	1
<b>EQUIVALENT MENU</b>	<b>MOD</b> > PULSE > Trigger Out
<b>EXAMPLE</b>	<i>:PULM:TRIGger:STATe OFF</i> <i>:PULM:TRIGger:STATe?</i> Return: <i>0</i>

#### 3.4.8.25 Pulse Trigger ([:SOURce]:PULM:TRIGger:MODE)

<b>SYNTAX</b>	<i>[:SOURce]:PULM:TRIGger:MODE AUTO KEY EXternal EGATe</i> <i>[:SOURce]:PULM:TRIGger:MODE?</i>
<b>DESCRIPTION</b>	This command sets/queries the pulse trigger mode.
<b>DATA TYPE</b>	Enumeration
<b>RANGE</b>	AUTO KEY EXternal EGATe
<b>RETURN</b>	Enumeration
<b>DEFAULT VALUE</b>	AUTO
<b>EQUIVALENT MENU</b>	<b>MOD</b> > PULSE > Pulse Trigger
<b>EXAMPLE</b>	<i>:PULM:TRIG:MODE EXternal</i> <i>:PULM:TRIGger:MODE?</i> Return: <i>EXternal</i>

#### 3.4.8.26 Trigger Delay ([:SOURce]:PULM:DELay)

<b>SYNTAX</b>	<i>[:SOURce]:PULM:DELay &lt;value&gt;</i> <i>[:SOURce]:PULM:DELay?</i>
<b>DESCRIPTION</b>	When the pulse trigger mode is EXternal, this command sets/queries the trigger delay.
<b>DATA TYPE</b>	Float, unit: ns, us, ms or s, default is s
<b>RANGE</b>	140 ns ~ 300 s
<b>RETURN</b>	Float, unit: s
<b>DEFAULT VALUE</b>	140 ns
<b>EQUIVALENT MENU</b>	<b>MOD</b> > PULSE > Trig Delay
<b>EXAMPLE</b>	<i>:PULM:DEL 30 ms</i> <i>:PULM:DELay?</i> Return: <i>0.03</i>

**3.4.8.27 Trigger Slope ([:SOURce]:PULM:TRIGger:EXTernal:SLOPe)**

<b>SYNTAX</b>	[:SOURce]:PULM:TRIGger:EXTernal:SLOPe NEGative POSitive [:SOURce]:PULM:TRIGger:EXTernal:SLOPe?
<b>DESCRIPTION</b>	When the pulse trigger mode is EXTernal, this command sets/queries the trigger edge of the external trigger signal.
<b>DATA TYPE</b>	Enumeration
<b>RANGE</b>	NEGative POSitive
<b>RETURN</b>	Enumeration
<b>DEFAULT VALUE</b>	POSitive
<b>EQUIVALENT MENU</b>	<span style="border: 1px solid black; padding: 2px;">MOD</span> > PULSE > Trigger Slope
<b>EXAMPLE</b>	<i>PULM:TRIG:EXT:SLOP NEG</i> <i>PULM:TRIG:EXT:SLOP?</i> Return: <i>NEGative\n</i>

**3.4.8.28 Trigger Polarity ([:SOURce]:PULM:TRIGger:EXTernal:GATE:POLarity)**

<b>SYNTAX</b>	[:SOURce]:PULM:TRIGger:EXTernal:GATE:POLarity NORMal INVerted [:SOURce]:PULM:TRIGger:EXTernal:GATE:POLarity?
<b>DESCRIPTION</b>	This command sets/queries the trigger polarity of the external gating signal for the pulse function.
<b>DATA TYPE</b>	Enumeration
<b>RANGE</b>	NORMal INVerted
<b>RETURN</b>	Enumeration
<b>DEFAULT VALUE</b>	NORMal
<b>EQUIVALENT MENU</b>	<span style="border: 1px solid black; padding: 2px;">MOD</span> > PULSE > Trig Polarity
<b>EXAMPLE</b>	<i>:PULM:TRIG:EXT:GATE:POL INVerted</i> <i>:PULM:TRIGger:EXTernal:GATE:POLarity?</i> Return: <i>INVerted\n</i>

**3.4.9 LF Source****3.4.9.1 LF State ([:SOURce]:LFOutput)**

<b>SYNTAX</b>	[:SOURce]:LFOutput ON OFF 1 0 [:SOURce]:LFOutput?
<b>DESCRIPTION</b>	This command sets/queries the output status of LF Source.
<b>DATA TYPE</b>	Boolean
<b>RANGE</b>	ON OFF 1 0

<b>RETURN</b>	1 0
<b>DEFAULT VALUE</b>	0
<b>EQUIVALENT MENU</b>	<span style="border: 1px solid black; padding: 2px;">LF</span> > LF Source > LF State
<b>EXAMPLE</b>	<i>LFOutput ON</i> <i>LFOutput?</i> Return: <i>1\n</i>

### 3.4.9.2 LF Level ([:SOURce]:LFOutput:VOLTage)

<b>SYNTAX</b>	[:SOURce]:LFOutput:VOLTage <voltage> [:SOURce]:LFOutput:VOLTage?
<b>DESCRIPTION</b>	This command sets/queries the level of the LF output signal.
<b>DATA TYPE</b>	Float, unit: dBm, uVpp, mVpp, Vpp, nW, uW or mW, default is Vpp
<b>RANGE</b>	1 mVpp ~ 3 Vpp
<b>RETURN</b>	Float, unit: Vpp
<b>DEFAULT VALUE</b>	0.5 Vpp
<b>EQUIVALENT MENU</b>	<span style="border: 1px solid black; padding: 2px;">LF</span> > LF Source > LF Level
<b>EXAMPLE</b>	<i>LFOutput:VOLTage 2 Vpp</i> <i>LFOutput:VOLTage?</i> Return: <i>2\n</i>

### 3.4.9.3 LF Offset ([:SOURce]:LFOutput:OFFSEt)

<b>SYNTAX</b>	[:SOURce]:LFOutput:OFFSEt <voltage> [:SOURce]:LFOutput:OFFSEt?
<b>DESCRIPTION</b>	This command sets/queries the amplitude offset of the LF output signal.
<b>DATA TYPE</b>	Float, unit: dBm, uV, mV, V, nW, uW or mW, default is V
<b>RANGE</b>	$ LFOffset  \leq \min(2.5V - \frac{1}{2} LEVEL, 2V)$
<b>RETURN</b>	Float, unit: V
<b>DEFAULT VALUE</b>	0
<b>EQUIVALENT MENU</b>	<span style="border: 1px solid black; padding: 2px;">LF</span> > LF Source > LF Offset
<b>EXAMPLE</b>	<i>LFOutput:OFFSEt 1 V</i> <i>LFOutput:OFFSEt?</i> Return: <i>1\n</i>



**3.4.9.4 LF Frequency ([:SOURce]:LFOutput:FREQuency)**

<b>SYNTAX</b>	<code>[:SOURce]:LFOutput:FREQuency &lt;freq&gt;</code> <code>[:SOURce]:LFOutput:FREQuency?</code>
<b>DESCRIPTION</b>	This command sets/queries the frequency of the LF output signal.
<b>DATA TYPE</b>	Float, unit: Hz, kHz, MHz or GHz, default is Hz
<b>RANGE</b>	LF wave is Sine: 0.01 Hz ~ 1 MHz, LF wave is Square\Triangle\Sawtooth: 0.01 Hz ~ 20 kHz.
<b>RETURN</b>	Float, unit: Hz
<b>DEFAULT VALUE</b>	1 kHz
<b>EQUIVALENT MENU</b>	<b>LF</b> > LF Source > LF Frequency
<b>EXAMPLE</b>	<i>LFOutput:FREQuency 10 kHz</i> <i>LFOutput:FREQuency?</i> Return: <i>10000\n</i>

**3.4.9.5 LF Shape ([:SOURce]:LFOutput:SHAPE)**

<b>SYNTAX</b>	<code>[:SOURce]:LFOutput:SHAPE SINE SQUare TRIangle SAWTooth DC</code> <code>[:SOURce]:LFOutput:SHAPE?</code>
<b>DESCRIPTION</b>	This command sets/queries the wave shape of the LF output signal.
<b>DATA TYPE</b>	Enumeration
<b>RANGE</b>	SINE SQUare TRIangle SAWTooth DC
<b>RETURN</b>	Enumeration
<b>DEFAULT VALUE</b>	SINE
<b>EQUIVALENT MENU</b>	<b>LF</b> > LF Source > LF Shape
<b>EXAMPLE</b>	<i>:LFOutput:SHAPE TRIangle</i> <i>:LFOutput:SHAPE?</i> Return: <i>TRIangle\n</i>

**3.4.9.6 LF Phase ([:SOURce]:LFOutput:PHASE)**

<b>SYNTAX</b>	<code>[:SOURce]:LFOutput:PHASE &lt;deg&gt;</code> <code>[:SOURce]:LFOutput:PHASE?</code>
<b>DESCRIPTION</b>	This command sets/queries the phase of the LF output signal.
<b>DATA TYPE</b>	Float, unit: degree (°)
<b>RANGE</b>	-360 ~ 360
<b>RETURN</b>	Float, unit: degree (°)
<b>DEFAULT VALUE</b>	0
<b>EQUIVALENT MENU</b>	<b>LF</b> > LF Source > LF Phase

---

**EXAMPLE**                    *LFOutput:PHASe 20*  
                                   *LFOutput:PHASe?*  
                                   Return:  
                                   *20\n*

---

### 3.4.10 LF Sweep

#### 3.4.10.1 Sweep State ([:SOURce]:LFOutput:SWEep)

---

<b>SYNTAX</b>	<i>[:SOURce]:LFOutput:SWEep ON OFF 1 0</i> <i>[:SOURce]:LFOutput:SWEep?</i>
<b>DESCRIPTION</b>	This command sets/queries the sweep status of LF signal.
<b>DATA TYPE</b>	Boolean
<b>RANGE</b>	ON OFF 1 0
<b>RETURN</b>	1 0
<b>DEFAULT VALUE</b>	0
<b>EQUIVALENT MENU</b>	<span style="border: 1px solid black; padding: 2px;">LF</span> > LF Sweep > Sweep State
<b>EXAMPLE</b>	<i>:LFOutput:SWEep 1</i> <i>:LFOutput:SWEep?</i> Return: <i>1\n</i>

---

#### 3.4.10.2 Sweep Direction ([:SOURce]:LFOutput:SWEep:DIRect)

---

<b>SYNTAX</b>	<i>[:SOURce]:LFOutput:SWEep:DIRect UP DOWN</i> <i>[:SOURce]:LFOutput:SWEep:DIRect?</i>
<b>DESCRIPTION</b>	This command sets/queries the direction of LF sweep.
<b>DATA TYPE</b>	Enumeration
<b>RANGE</b>	UP DOWN
<b>RETURN</b>	Enumeration
<b>DEFAULT VALUE</b>	UP
<b>EQUIVALENT MENU</b>	<span style="border: 1px solid black; padding: 2px;">LF</span> > LF Sweep > Direction
<b>EXAMPLE</b>	<i>:LFOutput:SWEep:DIRect DOWN</i> <i>:LFOutput:SWEep:DIRect?</i> Return: <i>DOWN\n</i>

---

#### 3.4.10.3 Start Freq ([:SOURce]:LFOutput:SWEep:STARt:FREQuency)

---

<b>SYNTAX</b>	<i>[:SOURce]:LFOutput:SWEep:STARt:FREQuency &lt;freq&gt;</i> <i>[:SOURce]:LFOutput:SWEep:STARt:FREQuency?</i>
<b>DESCRIPTION</b>	This command sets/queries the starting frequency of LF sweep.

---

<b>DATA TYPE</b>	Float, unit: Hz, kHz, MHz or GHz, default is Hz
<b>RANGE</b>	LF wave is Sine: 0.01 Hz ~ 1 MHz, LF wave is Square/Triangle/Sawtooth: 0.01 Hz ~ 20 kHz.
<b>RETURN</b>	Float, unit: Hz
<b>DEFAULT VALUE</b>	500 Hz
<b>EQUIVALENT MENU</b>	<b>LF</b> > LF Sweep > Start Freq
<b>EXAMPLE</b>	<i>:LFOutput:SWEEP:START:FREQUENCY 100</i> <i>:LFOutput:SWEEP:START:FREQUENCY?</i> Return: <i>100\n</i>

#### 3.4.10.4 Stop Freq ([:SOURce]:LFOutput:SWEEP:STOP:FREQUENCY)

<b>SYNTAX</b>	<i>[:SOURce]:LFOutput:SWEEP:STOP:FREQUENCY &lt;freq&gt;</i> <i>[:SOURce]:LFOutput:SWEEP:STOP:FREQUENCY?</i>
<b>DESCRIPTION</b>	This command sets/queries the stop frequency of LF sweep.
<b>DATA TYPE</b>	Float, unit: Hz, kHz, MHz or GHz, default is Hz
<b>RANGE</b>	LF wave is Sine: 0.01 Hz ~ 1 MHz, LF wave is Square/Triangle/Sawtooth: 0.01 Hz ~ 20 kHz.
<b>RETURN</b>	Float, unit: Hz
<b>DEFAULT VALUE</b>	1.5 kHz
<b>EQUIVALENT MENU</b>	<b>LF</b> > LF Sweep > Stop Freq
<b>EXAMPLE</b>	<i>:LFOutput:SWEEP:STOP:FREQUENCY 1000</i> <i>:LFOutput:SWEEP:STOP:FREQUENCY?</i> Return: <i>1000\n</i>

#### 3.4.10.5 Center Freq ([:SOURce]:LFOutput:SWEEP:CENTER:FREQUENCY)

<b>SYNTAX</b>	<i>[:SOURce]:LFOutput:SWEEP:CENTER:FREQUENCY &lt;freq&gt;</i> <i>[:SOURce]:LFOutput:SWEEP:CENTER:FREQUENCY?</i>
<b>DESCRIPTION</b>	This command sets/queries the center frequency of LF sweep.
<b>DATA TYPE</b>	Float, unit: Hz, kHz, MHz or GHz, default is Hz
<b>RANGE</b>	LF wave is Sine: 0.01 Hz ~ 1 MHz, LF wave is Square/Triangle/Sawtooth: 0.01 Hz ~ 20 kHz.
<b>RETURN</b>	Float, unit: Hz
<b>DEFAULT VALUE</b>	1 kHz
<b>EQUIVALENT MENU</b>	<b>LF</b> > LF Sweep > Center Freq
<b>EXAMPLE</b>	<i>:LFOutput:SWEEP:CENTER:FREQUENCY 550</i> <i>:LFOutput:SWEEP:CENTER:FREQUENCY?</i> Return: <i>550\n</i>

**3.4.10.6 Freq Span ([:SOURce]:LFOutput:SWEep:SPAN:FREQuency)**

<b>SYNTAX</b>	<code>[:SOURce]:LFOutput:SWEep:SPAN:FREQuency &lt;freq&gt;</code> <code>[:SOURce]:LFOutput:SWEep:SPAN:FREQuency?</code>
<b>DESCRIPTION</b>	This command sets/queries the frequency span of LF sweep.
<b>DATA TYPE</b>	Float, unit: Hz, kHz, MHz or GHz, default is Hz
<b>RANGE</b>	LF wave is Sine: 0.00 Hz ~ 999.99999 kHz, LF wave is Square/Triangle/Sawtooth: 0.00 Hz ~ 19.99999 kHz.
<b>RETURN</b>	Float, unit: Hz
<b>DEFAULT VALUE</b>	1 kHz
<b>EQUIVALENT MENU</b>	<b>LF</b> > LF Sweep > Freq Span
<b>EXAMPLE</b>	<code>:LFOutput:SWEep:SPAN:FREQuency 550</code> <code>:LFOutput:SWEep:SPAN:FREQuency?</code> Return: <code>550</code>

**3.4.10.7 Sweep Time ([:SOURce]:LFOutput:SWEep:DWELI)**

<b>SYNTAX</b>	<code>[:SOURce]:LFOutput:SWEep:DWELI &lt;time&gt;</code> <code>[:SOURce]:LFOutput:SWEep:DWELI?</code>
<b>DESCRIPTION</b>	This command sets/queries the sweep time of LF sweep.
<b>DATA TYPE</b>	Float, unit: ns, us, ms or s, default is s
<b>RANGE</b>	1 ms ~ 500 s
<b>RETURN</b>	Float, unit: s
<b>DEFAULT VALUE</b>	1 s
<b>EQUIVALENT MENU</b>	<b>LF</b> > LF Sweep > Sweep Time
<b>EXAMPLE</b>	<code>:LFOutput:SWEep:DWELI 2 s</code> <code>:LFOutput:SWEep:DWELI?</code> Return: <code>2</code>

**3.4.10.8 Trigger Mode ([:SOURce]:LFOutput:SWEep:TRIGger:TYPE)**

<b>SYNTAX</b>	<code>[:SOURce]:LFOutput:SWEep:TRIGger:TYPE AUTO KEY BUS EXT</code> <code>[:SOURce]:LFOutput:SWEep:TRIGger:TYPE?</code>
<b>DESCRIPTION</b>	This command sets/queries the sweep trigger mode of LF sweep.
<b>DATA TYPE</b>	Enumeration
<b>RANGE</b>	AUTO KEY BUS EXT
<b>RETURN</b>	Enumeration
<b>DEFAULT VALUE</b>	AUTO
<b>EQUIVALENT MENU</b>	<b>LF</b> > LF Sweep > Trigger Mode
<b>EXAMPLE</b>	<code>:LFOutput:SWEep:TRIGger:TYPE KEY</code> <code>:LFOutput:SWEep:TRIGger:TYPE?</code>

---

Return:  
*KEYn*

---

#### 3.4.10.9 Trigger Slope ([:SOURce]:LFOutput:SWEep:XPOLar)

<b>SYNTAX</b>	<i>[:SOURce]:LFOutput:SWEep:XPOLar POS NEG</i> <i>[:SOURce]:LFOutput:SWEep:XPOLar?</i>
<b>DESCRIPTION</b>	This command sets/queries the trigger edge of the external trigger signal for the LF sweep function.
<b>DATA TYPE</b>	Enumeration
<b>RANGE</b>	POS NEG
<b>RETURN</b>	Enumeration
<b>DEFAULT VALUE</b>	POS
<b>EQUIVALENT MENU</b>	<span style="border: 1px solid black; padding: 2px;">LF</span> > LF Sweep > Trigger Slope
<b>EXAMPLE</b>	<i>:LFOutput:SWEep:XPOLar POS</i> <i>:LFOutput:SWEep:XPOLar?</i> Return: <i>POSn</i>

#### 3.4.10.10 Sweep Shape ([:SOURce]:LFOutput:SWEep:SHAPE)

<b>SYNTAX</b>	<i>[:SOURce]:LFOutput:SWEep:SHAPE TRlangle SAWTooth</i> <i>[:SOURce]:LFOutput:SWEep:SHAPE?</i>
<b>DESCRIPTION</b>	This command sets/queries the sweep shape of LF sweep.
<b>DATA TYPE</b>	Enumeration
<b>RANGE</b>	TRlangle SAWTooth
<b>RETURN</b>	Enumeration
<b>DEFAULT VALUE</b>	SAWTooth
<b>EQUIVALENT MENU</b>	<span style="border: 1px solid black; padding: 2px;">LF</span> > LF Sweep > Sweep Shape
<b>EXAMPLE</b>	<i>:LFOutput:SWEep:SHAPE TRlangle</i> <i>:LFOutput:SWEep:SHAPE?</i> Return: <i>TRlanglen</i>

#### 3.4.10.11 Sweep Space ([:SOURce]:LFOutput:SWEep:SPACing)

<b>SYNTAX</b>	<i>[:SOURce]:LFOutput:SWEep:SPACing LINear LOGarithmic</i> <i>[:SOURce]:LFOutput:SWEep:SPACing?</i>
<b>DESCRIPTION</b>	This command sets/queries the frequency sweep space of LF sweep.
<b>DATA TYPE</b>	Enumeration
<b>RANGE</b>	LINear LOGarithmic
<b>RETURN</b>	Enumeration

DEFAULT VALUE	LINear
EQUIVALENT MENU	<b>LF</b> > LF Sweep > Sweep Space
EXAMPLE	<i>:LFOutput:SWEEP:SPACing LOGarithmic</i> <i>:LFOutput:SWEEP:SPACing?</i> Return: <i>LOGarithmic</i>

### 3.4.11 System Preset

#### 3.4.11.1 Preset (:SOURce:PRESet)

SYNTAX	:SOURce:PRESet
DESCRIPTION	This command sets the instrument status to factory settings.
EQUIVALENT MENU	None
EXAMPLE	<i>:SOURce:PRESet</i>

### 3.4.12 IQ Modulation

#### 3.4.12.1 IQ Modulation Switch ([:SOURce]:FUNCtion:DM:STATe)

SYNTAX	<i>[:SOURce]:FUNCtion:DM:STATe ON OFF 1 0</i> <i>[:SOURce]:FUNCtion:DM:STATe?</i>
DESCRIPTION	This command sets/queries the overall switch status of IQ modulation. <b>Note:</b> When turning on the IQ modulation function, this switch must be turned on to turn on the modulation function.
DATA TYPE	Boolean
RANGE	ON OFF 1 0
RETURN	1 0
DEFAULT VALUE	0
EQUIVALENT MENU	<b>HOME</b> > IQ MOD > On, or <b>MOD ON/OFF</b>
EXAMPLE	<i>:FUNCtion:DM:STATe ON</i> <i>:FUNCtion:DM:STATe?</i> Return: <i>1</i>

### 3.4.13 Custom

#### 3.4.13.1 Custom State ([:SOURce]:RADio:CUSTom[:STATe])

SYNTAX	<i>[:SOURce]:RADio:CUSTom[:STATe] ON OFF 1 0</i> <i>[:SOURce]:RADio:CUSTom[:STATe]?</i>
DESCRIPTION	This command sets/gets the switch status of Custom modulation.

<b>DATA TYPE</b>	Boolean
<b>RANGE</b>	ON OFF 1 0
<b>RETURN</b>	1 0
<b>DEFAULT VALUE</b>	0
<b>EQUIVALENT MENU</b>	<input type="text" value="IQ"/> > Custom > Custom State
<b>EXAMPLE</b>	<i>:RADio:CUSTom 1</i> <i>:RADio:CUSTom?</i> Return: <i>1</i>

### 3.4.13.2 Data Setup ([:SOURce]:RADio:CUSTom:DATA)

<b>SYNTAX</b>	<i>[:SOURce]:RADio:CUSTom:DATA PN7 PN9 PN15 PN23 USER</i> <i>[:SOURce]:RADio:CUSTom:DATA?</i>
<b>DESCRIPTION</b>	This command sets/queries the data pattern for unframed transmission of Custom modulation.
<b>DATA TYPE</b>	Enumeration
<b>RANGE</b>	PN7 PN9 PN15 PN23 USER
<b>RETURN</b>	Enumeration
<b>DEFAULT VALUE</b>	PN7
<b>EQUIVALENT MENU</b>	<input type="text" value="IQ"/> > Custom > Data Source > Data Setup
<b>EXAMPLE</b>	<i>:RADio:CUSTom:DATA PN9</i> <i>:RADio:CUSTom:DATA?</i> Return: <i>PN9</i>

### 3.4.13.3 Symbol Rate ([:SOURce]:RADio:CUSTom:SRATe)

<b>SYNTAX</b>	<i>[:SOURce]:RADio:CUSTom:SRATe &lt;val&gt;</i> <i>[:SOURce]:RADio:CUSTom:SRATe?</i>
<b>DESCRIPTION</b>	This command sets/queries the transmission symbol rate of Custom modulation.
<b>DATA TYPE</b>	Float, unit: Sps
<b>RANGE</b>	500 Sps ~ 120 MSps
<b>RETURN</b>	Float, unit: Sps
<b>DEFAULT VALUE</b>	1 MSps
<b>EQUIVALENT MENU</b>	<input type="text" value="IQ"/> > Custom > Data Source > Symbol Rate
<b>EXAMPLE</b>	<i>:RADio:CUSTom:SRATe 2000000</i> <i>:RADio:CUSTom:SRATe?</i> Return: <i>2000000</i>

**3.4.13.4 Symbol Length ([:SOURce]:RADio:CUSTom:SLENgth)**

<b>SYNTAX</b>	<code>[:SOURce]:RADio:CUSTom:SLENgth &lt;val&gt;</code> <code>[:SOURce]:RADio:CUSTom:SLENgth?</code>
<b>DESCRIPTION</b>	This command sets/queries the transmission symbol length of Custom modulation.
<b>DATA TYPE</b>	Integer
<b>RANGE</b>	100 ~ 100000
<b>RETURN</b>	Integer
<b>DEFAULT VALUE</b>	512
<b>EQUIVALENT MENU</b>	<b>IQ</b> > Custom > Data Source > Symbol Length
<b>EXAMPLE</b>	<code>:RADio:CUSTom:SLENgth 1024</code> <code>:RADio:CUSTom:SLENgth?</code> Return: <code>1024</code>

**3.4.13.5 Bits/Symbol ([:SOURce]:RADio:CUSTom:SBIT?)**

<b>SYNTAX</b>	<code>[:SOURce]:RADio:CUSTom:SBIT?</code>
<b>DESCRIPTION</b>	This command gets the transmission bits per symbol of Custom modulation. This value is determined by the modulation type.
<b>RETURN</b>	Integer
<b>DEFAULT VALUE</b>	4
<b>EQUIVALENT MENU</b>	<b>IQ</b> > Custom > Data Source > Bits/Symbol
<b>EXAMPLE</b>	<code>:RADio:CUSTom:SBIT?</code> Return: <code>4</code>

**3.4.13.6 Mod Type ([:SOURce]:RADio:CUSTom:MODulation[:TYPE])**

<b>SYNTAX</b>	<code>[:SOURce]:RADio:CUSTom:MODulation[:TYPE] ASK2  ASK4  ASK8  ASK16  BPSK  QPSK  PSK8  DBPSK  DQPSK  D8PSK  PI4DQPSK  PI8D8PSK  OQPSK  QAM16  QAM32  QAM64  QAM128  QAM256  QAM512  FSK2  FSK4  FSK8  FSK16  MSK1  USER</code> <code>[:SOURce]:RADio:CUSTom:MODulation[:TYPE]?</code>
<b>DESCRIPTION</b>	This command sets/queries the modulation type for the custom modulation.
<b>DATA TYPE</b>	Enumeration
<b>RANGE</b>	ASK2  ASK4  ASK8  ASK16  BPSK  QPSK  PSK8  DBPSK  DQPSK  D8PSK  PI4DQPSK  PI8D8PSK  OQPSK  QAM16  QAM32  QAM64  QAM128  QAM256  QAM512  FSK2  FSK4  FSK8  FSK16  MSK1  USER
<b>RETURN</b>	Enumeration
<b>DEFAULT VALUE</b>	QAM16



<b>EQUIVALENT MENU</b>	<code>[IQ] &gt; Custom &gt; Modulation &gt; Mod Type</code>
<b>EXAMPLE</b>	<code>:RADio:CUSTom:MODulation ASK2</code> <code>:RADio:CUSTom:MODulation?</code> Return: <code>ASK2\n</code>

#### 3.4.13.7 Gray ([:SOURce]:RADio:CUSTom:MODulation:GRAY)

<b>SYNTAX</b>	<code>[[:SOURce]:RADio:CUSTom:MODulation:GRAY ON OFF 1 0</code> <code>[[:SOURce]:RADio:CUSTom:MODulation:GRAY?</code>
<b>DESCRIPTION</b>	This command sets/queries whether the Custom modulation symbol uses Gray code encoding.
<b>DATA TYPE</b>	Boolean
<b>RANGE</b>	ON OFF 1 0
<b>RETURN</b>	1 0
<b>DEFAULT VALUE</b>	0
<b>EQUIVALENT MENU</b>	<code>[IQ] &gt; Custom &gt; Modulation &gt; Gray</code>
<b>EXAMPLE</b>	<code>:RADio:CUSTom:MODulation:GRAY 1</code> <code>:RADio:CUSTom:MODulation:GRAY?</code> Return: <code>1\n</code>

#### 3.4.13.8 Store User-defined IQ Data ([:SOURce]:RADio:CUSTom:MODulation:STORe)

<b>SYNTAX</b>	<code>[[:SOURce]:RADio:CUSTom:MODulation:STORe &lt;"file_name"&gt;</code>
<b>DESCRIPTION</b>	This command saves the user-defined I/Q data to a MAP file.
<b>DATA TYPE</b>	String
<b>RANGE</b>	Please refer to the user manual for naming rules.
<b>EQUIVALENT MENU</b>	<code>[IQ] &gt; Custom &gt; Modulation &gt; Mod Type(User) &gt; Custom &gt; Save</code>
<b>EXAMPLE</b>	<code>:RADio:CUSTom:MODulation:STORe "test.map"</code>

#### 3.4.13.9 Load User-defined IQ Data ([:SOURce]:RADio:CUSTom:MODulation:LOAD)

<b>SYNTAX</b>	<code>[[:SOURce]:RADio:CUSTom:MODulation:LOAD &lt;"file_name"&gt;</code>
<b>DESCRIPTION</b>	This command loads the I/Q data from a MAP file.
<b>DATA TYPE</b>	String
<b>RANGE</b>	None
<b>EQUIVALENT MENU</b>	<code>[IQ] &gt; Custom &gt; Modulation &gt; Mod Type(User) &gt; Custom &gt; Load</code>
<b>EXAMPLE</b>	<code>:RADio:CUSTom:MODulation:LOAD "test.map"</code>

**3.4.13.10 Get User-defined IQ Data ([:SOURce]:RADio:CUSTom:MODulation:UIQ?)**

<b>SYNTAX</b>	<code>[:SOURce]:RADio:CUSTom:MODulation:UIQ?</code>
<b>DESCRIPTION</b>	This command gets the user-defined I/Q data.
<b>RETURN</b>	String Format: I value Q value\nI value Q value\n...I value Q value\n\n
<b>DEFAULT VALUE</b>	0.632456 0.000000\n1.264911 0.000000\n\n
<b>EQUIVALENT MENU</b>	<b>IQ</b> > Custom > Modulation > Mod Type(User) > Custom
<b>EXAMPLE</b>	<code>:RADio:CUSTom:MODulation:UIQ?</code> Return: <code>0.632456 0.000000\n0.700000 -0.700000\n-0.700000 0.700000\n1.264910 0.000000\n\n</code>

**3.4.13.11 Insert User-defined IQ Data ([:SOURce]:RADio:CUSTom:MODulation:INSErt)**

<b>SYNTAX</b>	<code>[:SOURce]:RADio:CUSTom:MODulation:INSErt &lt;symbol&gt;, &lt;i data&gt;,&lt;q data&gt;</code>
<b>DESCRIPTION</b>	This command inserts a row into a user-defined IQ data list.
<b>DATA TYPE</b>	symbol: integer, i data: float, q data: float
<b>RANGE</b>	symbol: 0 ~ (current total number of symbols - 1), i data: -1 ~ 1, q data: -1 ~ 1
<b>EQUIVALENT MENU</b>	<b>IQ</b> > Custom > Modulation > Mod Type(User) > Custom > Insert
<b>EXAMPLE</b>	<code>:RADio:CUSTom:MODulation:INSErt 0,0.5,0.5</code>

**3.4.13.12 Edit User-defined IQ Data ([:SOURce]:RADio:CUSTom:MODulation:CHANge)**

<b>SYNTAX</b>	<code>[:SOURce]:RADio:CUSTom:MODulation:CHANge &lt;symbol&gt;, &lt;i data&gt;,&lt;q data&gt;</code>
<b>DESCRIPTION</b>	This command edits the specified row in the user-defined IQ data list.
<b>DATA TYPE</b>	symbol: integer, i data: float, q data: float
<b>RANGE</b>	symbol: 0 ~ (current total number of symbols - 1), i data: -1 ~ 1, q data: -1 ~ 1
<b>EQUIVALENT MENU</b>	<b>IQ</b> > Custom > Modulation > Mod Type(User) > Custom
<b>EXAMPLE</b>	<code>:RADio:CUSTom:MODulation:CHANge 0,0.5,0.5</code>

**3.4.13.13 Delete User-defined IQ Data ([:SOURce]:RADio:CUSTom:MODulation:DELEte)**

<b>SYNTAX</b>	<code>[:SOURce]:RADio:CUSTom:MODulation:DELEte &lt;symbol&gt;</code>
---------------	--

<b>DESCRIPTION</b>	This command removes a specified row from the user-defined IQ data list.
<b>DATA TYPE</b>	Integer
<b>RANGE</b>	0 ~ (current total number of symbols - 1)
<b>EQUIVALENT MENU</b>	<span style="border: 1px solid black; padding: 2px;">IQ</span> > Custom > Modulation > Mod Type(User) > Custom > Delete
<b>EXAMPLE</b>	<i>:RADio:CUSTom:MODulation:DELEte 0</i>

#### 3.4.13.14 Clear User-defined IQ Data ([:SOURce]:RADio:CUSTom:MODulation:CLEAR)

<b>SYNTAX</b>	<code>[:SOURce]:RADio:CUSTom:MODulation:CLEAR</code>
<b>DESCRIPTION</b>	This command resets the user-defined IQ data list to default values.
<b>EQUIVALENT MENU</b>	<span style="border: 1px solid black; padding: 2px;">IQ</span> > Custom > Modulation > Mod Type(User) > Custom > Clear
<b>EXAMPLE</b>	<i>:RADio:CUSTom:MODulation:CLEAR</i>

#### 3.4.13.15 FSK Deviation ([:SOURce]:RADio:CUSTom:MODulation:FSK[:DEViation])

<b>SYNTAX</b>	<code>[:SOURce]:RADio:CUSTom:MODulation:FSK[:DEViation] &lt;val&gt;</code> <code>[:SOURce]:RADio:CUSTom:MODulation:FSK[:DEViation]?</code>
<b>DESCRIPTION</b>	This command sets/queries the symmetric FSK frequency deviation value.
<b>DATA TYPE</b>	Float, unit: Hz
<b>RANGE</b>	0 ~ 0.8*Symbol Rate*Oversampling
<b>RETURN</b>	Float, unit: Hz
<b>DEFAULT VALUE</b>	600000
<b>EQUIVALENT MENU</b>	<span style="border: 1px solid black; padding: 2px;">IQ</span> > Custom > Modulation > Mod Type(FSK) > FSK Deviation
<b>EXAMPLE</b>	<i>:RADio:CUSTom:MODulation:FSK:DEViation 450e3</i> <i>:RADio:CUSTom:MODulation:FSK:DEViation?</i> Return: <i>450000\n</i>

#### 3.4.13.16 Filter Type ([:SOURce]:RADio:CUSTom:FILTer)

<b>SYNTAX</b>	<code>[:SOURce]:RADio:CUSTom:FILTer NONE  RAISecosine  ROOTcosine  GAUSSian</code> <code>[:SOURce]:RADio:CUSTom:FILTer?</code>
<b>DESCRIPTION</b>	This command sets/queries the filter type of the Custom modulation.
<b>DATA TYPE</b>	Enumeration
<b>RANGE</b>	NONE  RAISecosine  ROOTcosine  GAUSSian
<b>RETURN</b>	Enumeration
<b>DEFAULT VALUE</b>	ROOTcosine

---

**EQUIVALENT MENU**    `[IQ] > Custom > Filter > Filter Type`

---

**EXAMPLE**                    `:RADio:CUSTom:FILTer GAUSSian`  
                                   `:RADio:CUSTom:FILTer?`  
 Return:  
                                   `GAUSSian`

---

#### 3.4.13.17 Filter Alpha/BT (`[[:SOURce]:RADio:CUSTom:ALPHa]`)

---

**SYNTAX**                    `[[:SOURce]:RADio:CUSTom:ALPHa <val>`  
                                   `[[:SOURce]:RADio:CUSTom:ALPHa?`

---

**DESCRIPTION**            This command sets/queries the alpha value of a Nyquist or root Nyquist filter or the BT value of a Gaussian filter.

---

**DATA TYPE**                Float

---

**RANGE**                    0.010 ~ 1.000

---

**RETURN**                    Float

---

**DEFAULT VALUE**          0.350

---

**EQUIVALENT MENU**    `[IQ] > Custom > Filter > Filter Alpha/BT`

---

**EXAMPLE**                    `:RADio:CUSTom:ALPHa 0.22`  
                                   `:RADio:CUSTom:ALPHa?`  
 Return:  
                                   `0.22`

---

#### 3.4.13.18 Filter Length (`[[:SOURce]:RADio:CUSTom:FILTer:LENGth]`)

---

**SYNTAX**                    `[[:SOURce]:RADio:CUSTom:FILTer:LENGth <length>`  
                                   `[[:SOURce]:RADio:CUSTom:FILTer:LENGth?`

---

**DESCRIPTION**            This command sets/queries the filter length of Custom modulation.

---

**DATA TYPE**                Integer

---

**RANGE**                    1 ~ 512

---

**RETURN**                    Integer

---

**DEFAULT VALUE**          128

---

**EQUIVALENT MENU**    `[IQ] > Custom > Filter > Filter Length`

---

**EXAMPLE**                    `:RADio:CUSTom:FILTer:LENGth 64`  
                                   `:RADio:CUSTom:FILTer:LENGth?`  
 Return:  
                                   `64`

---

#### 3.4.13.19 OverSampling (`[[:SOURce]:RADio:CUSTom:FILTer:OSAMple]`)

---

**SYNTAX**                    `[[:SOURce]:RADio:CUSTom:FILTer:OSAMple <val>`  
                                   `[[:SOURce]:RADio:CUSTom:FILTer:OSAMple?`

---

**DESCRIPTION**            This command sets/queries the oversampling value of the Custom modulation filter.

---

<b>DATA TYPE</b>	Integer
<b>RANGE</b>	2 ~ 32
<b>RETURN</b>	Integer
<b>DEFAULT VALUE</b>	2
<b>EQUIVALENT MENU</b>	<span style="border: 1px solid black; padding: 0 2px;">IQ</span> > Custom > Filter > OverSampling
<b>EXAMPLE</b>	<i>:RADio:CUSTom:FILTer:OSAMple 4</i> <i>:RADio:CUSTom:FILTer:OSAMple?</i> Return: <i>4\n</i>

#### 3.4.13.20 Bit Rate ([:SOURce]:RADio:CUSTom:BRATe?)

<b>SYNTAX</b>	[:SOURce]:RADio:CUSTom:BRATe?
<b>DESCRIPTION</b>	This command queries the bit rate of Custom modulation in bits per second.
<b>RETURN</b>	Float, unit: bps
<b>DEFAULT VALUE</b>	4 MSps
<b>EQUIVALENT MENU</b>	None
<b>EXAMPLE</b>	<i>:RADio:CUSTom:BRATe?</i> Return: <i>4000000\n</i>

#### 3.4.13.21 Save Waveform ([:SOURce]:RADio:CUSTom:SAVE)

<b>SYNTAX</b>	[:SOURce]:RADio:CUSTom:SAVE <"file_name">
<b>DESCRIPTION</b>	This command saves Custom modulated waveform data to an ARB file.
<b>DATA TYPE</b>	String
<b>RANGE</b>	Please refer to the user manual for naming rules.
<b>EQUIVALENT MENU</b>	<span style="border: 1px solid black; padding: 0 2px;">IQ</span> > Custom > Save Waveform
<b>EXAMPLE</b>	<i>:RADio:CUSTom:SAVE "test.arb"</i>

#### 3.4.13.22 Update ([:SOURce]:RADio:CUSTom:DOWNload)

<b>SYNTAX</b>	[:SOURce]:RADio:CUSTom:DOWNload
<b>DESCRIPTION</b>	This command updates the settings for Custom modulation.
<b>EQUIVALENT MENU</b>	<span style="border: 1px solid black; padding: 0 2px;">IQ</span> > Custom > Update
<b>EXAMPLE</b>	<i>:RADio:CUSTom:DOWNload</i>

### 3.4.14 ARB

#### 3.4.14.1 ARB State ([:SOURce]:RADio:ARB[:STATe])

<b>SYNTAX</b>	<code>[:SOURce]:RADio:ARB[:STATe] ON OFF 1 0</code> <code>[:SOURce]:RADio:ARB[:STATe]?</code>
<b>DESCRIPTION</b>	This command sets/gets the switch status of ARB modulation.
<b>DATA TYPE</b>	Boolean
<b>RANGE</b>	ON OFF 1 0
<b>RETURN</b>	1 0
<b>DEFAULT VALUE</b>	0
<b>EQUIVALENT MENU</b>	<input type="text" value="IQ"/> > ARB > ARB State
<b>EXAMPLE</b>	<code>:RADio:ARB 1</code> <code>:RADio:ARB?</code> Return: <code>1\n</code>

#### 3.4.14.2 Select Waveform ([:SOURce]:RADio:ARB:WAVeform)

<b>SYNTAX</b>	<code>[:SOURce]:RADio:ARB:WAVeform</code> <code>&lt;"WFM:segment" "SEQ:sequence"&gt;</code> <code>[:SOURce]:RADio:ARB:WAVeform?</code>
<b>DESCRIPTION</b>	This command sets/queries the waveform segment or waveform sequence currently played by ARB.
<b>DATA TYPE</b>	String
<b>RANGE</b>	"WFM:segment": waveform name in <input type="text" value="IQ"/> > ARB > Waveform Segment, "SEQ:sequence": waveform name in <input type="text" value="IQ"/> > ARB > Waveform Sequence.
<b>RETURN</b>	String
<b>DEFAULT VALUE</b>	*NONE
<b>EQUIVALENT MENU</b>	<input type="text" value="IQ"/> > ARB > Select Waveform
<b>EXAMPLE</b>	<code>:RADio:ARB:WAVeform "WFM:SINE_WAVE"</code> <code>:RADio:ARB:WAVeform?</code> Return: <code>WFM:SINE_WAVE\n</code>  <code>:RADio:ARB:WAVeform "SEQ:test_seq"</code> <code>:RADio:ARB:WAVeform?</code> Return: <code>SEQ:test_seq\n</code>

#### 3.4.14.3 Get Segment List ([:SOURce]:IQ:DUALarb:SEGMENT:NAMES?)

<b>SYNTAX</b>	<code>[:SOURce]:IQ:DUALarb:SEGMENT:NAMES?</code>
---------------	--

<b>DESCRIPTION</b>	This command queries the list of waveform segments in ARB.
<b>RETURN</b>	String Format: segment_name sample_points\nsegment_name sample_points\n... segment_name sample_points\n
<b>DEFAULT VALUE</b>	RAMP_WAVE 200\nSINE_WAVE 200\n
<b>EQUIVALENT MENU</b>	<input type="checkbox"/> IQ > ARB > Waveform Segment
<b>EXAMPLE</b>	<i>:IQ:DUALarb:SEGMENT:NAME?</i> Return: <i>RAMP_WAVE 200\nSINE_WAVE 200\n</i>

#### 3.4.14.4 Load Segment ([:SOURce]:IQ:DUALarb:SEGMENT:LOAD)

<b>SYNTAX</b>	[:SOURce]:IQ:DUALarb:SEGMENT:LOAD <"file_name">
<b>DESCRIPTION</b>	This command loads a waveform segment file in the ARB segment list. The file types that can be loaded are: *.arb, *.wdbin, *.txt.
<b>DATA TYPE</b>	String
<b>RANGE</b>	None
<b>EQUIVALENT SCPI</b>	[:SOURce]:IQ:DUALarb:SEGMENT:LOAD:DATA <"file_name"> [:SOURce]:IQ:DUALarb:SEGMENT:LOAD:TEXT <"file_name">
<b>EQUIVALENT MENU</b>	<input type="checkbox"/> IQ > ARB > Waveform Segment > Load
<b>EXAMPLE</b>	<i>:IQ:DUALarb:SEGMENT:LOAD "Local/test.arb"</i> <i>:IQ:DUALarb:SEGMENT:LOAD "Local/sine.wdbin"</i> <i>:IQ:DUALarb:SEGMENT:LOAD "Local/16qam.txt"</i>

#### 3.4.14.5 Load Segment ([:SOURce]:IQ:DUALarb:SEGMENT:LOAD:DATA)

<b>SYNTAX</b>	[:SOURce]:IQ:DUALarb:SEGMENT:LOAD:DATA <"file_name">
<b>DESCRIPTION</b>	This command loads a waveform segment file in the ARB segment list. The file types that can be loaded are: *.arb, *.wdbin, *.txt.
<b>DATA TYPE</b>	String
<b>RANGE</b>	None
<b>EQUIVALENT SCPI</b>	[:SOURce]:IQ:DUALarb:SEGMENT:LOAD <"file_name"> [:SOURce]:IQ:DUALarb:SEGMENT:LOAD:TEXT <"file_name">
<b>EQUIVALENT MENU</b>	<input type="checkbox"/> IQ > ARB > Waveform Segment > Load
<b>EXAMPLE</b>	<i>:IQ:DUALarb:SEGMENT:LOAD:DATA "Local/test.arb"</i> <i>:IQ:DUALarb:SEGMENT:LOAD:DATA "Local/sine.wdbin"</i> <i>:IQ:DUALarb:SEGMENT:LOAD:DATA "Local/16qam.txt"</i>

#### 3.4.14.6 Load Segment ([:SOURce]:IQ:DUALarb:SEGMENT:LOAD:TEXT)

<b>SYNTAX</b>	[:SOURce]:IQ:DUALarb:SEGMENT:LOAD:TEXT <"file_name">
<b>DESCRIPTION</b>	This command loads a waveform segment file in the ARB segment list. The file types that can be loaded are: *.arb, *.wdbin, *.txt.

<b>DATA TYPE</b>	String
<b>RANGE</b>	None
<b>EQUIVALENT SCPI</b>	<code>[[:SOURce]:IQ:DUALarb:SEGment:LOAD &lt;"file_name"&gt; [:SOURce]:IQ:DUALarb:SEGment:LOAD:DATA &lt;"file_name"&gt;</code>
<b>EQUIVALENT MENU</b>	<code>[IQ] &gt; ARB &gt; Waveform Segment &gt; Load</code>
<b>EXAMPLE</b>	<code>:IQ:DUALarb:SEGment:LOAD:TEXT "Local/test.arb" :IQ:DUALarb:SEGment:LOAD:TEXT "Local/sine.wdbin" :IQ:DUALarb:SEGment:LOAD:TEXT "Local/16qam.txt"</code>

#### 3.4.14.7 Delete Segment (`[[:SOURce]:IQ:DUALarb:SEGment:DEL]`)

<b>SYNTAX</b>	<code>[[:SOURce]:IQ:DUALarb:SEGment:DEL &lt;"segment"&gt;</code>
<b>DESCRIPTION</b>	This command deletes a waveform segment from the waveform segment list.
<b>DATA TYPE</b>	String
<b>RANGE</b>	Waveform name in <code>[IQ] &gt; ARB &gt; Waveform Segment</code>
<b>EQUIVALENT MENU</b>	<code>[IQ] &gt; ARB &gt; Waveform Segment &gt; Delete</code>
<b>EXAMPLE</b>	<code>:IQ:DUALarb:SEGment:DEL "sine"</code>

#### 3.4.14.8 Rename Segment (`[[:SOURce]:IQ:DUALarb:SEGment:RENAmE]`)

<b>SYNTAX</b>	<code>[[:SOURce]:IQ:DUALarb:SEGment:RENAmE &lt;"original_name"&gt;,&lt;"new_name"&gt;</code>
<b>DESCRIPTION</b>	This command renames the name of a waveform segment in the ARB segment list.
<b>DATA TYPE</b>	String, string
<b>RANGE</b>	original_name: waveform name in <code>[IQ] &gt; ARB &gt; Waveform Segment</code> , new_name: Please refer to the user manual for naming rules.
<b>EQUIVALENT MENU</b>	<code>[IQ] &gt; ARB &gt; Waveform Segment &gt; Rename</code>
<b>EXAMPLE</b>	<code>:IQ:DUALarb:SEGment:RENAmE "test","RENAME_WAVE"</code>

#### 3.4.14.9 Clear Segment (`[[:SOURce]:IQ:DUALarb:SEGment:CLEAR]`)

<b>SYNTAX</b>	<code>[[:SOURce]:IQ:DUALarb:SEGment:CLEAR</code>
<b>DESCRIPTION</b>	This command clears the ARB segment list. <b>Note:</b> The waveform segment being played will be retained.
<b>EQUIVALENT MENU</b>	<code>[IQ] &gt; ARB &gt; Waveform Segment &gt; Clear</code>
<b>EXAMPLE</b>	<code>:IQ:DUALarb:SEGment:CLEAR</code>



**3.4.14.10 Create Sequence ([:SOURce]:RADio:ARB:SEquence)**

<b>SYNTAX</b>	<code>[:SOURce]:RADio:ARB:SEquence &lt;"file_name"&gt;,&lt;"waveform1"&gt;,&lt;reps&gt;,&lt;marker&gt;,{&lt;"waveform2"&gt;,&lt;reps&gt;,&lt;marker&gt;,...} [:SOURce]:RADio:ARB:SEquence? &lt;"file_name"&gt;</code>
<b>DESCRIPTION</b>	This command creates a waveform sequence composed of segments and other sequences. Segments and sequences play in the same order as the commands are placed in the waveform sequence. The query command returns the contents of the waveform sequence.
<b>DATA TYPE</b>	file_name: string, the name of the waveform sequence to be created, waveform: string, waveform segment or sequence name, reps: integer, number of waveform repetitions, marker: enumeration, identification point of the waveform.
<b>RANGE</b>	file_name: please refer to the user manual for naming rules, waveform: waveform name in <code>[IQ] &gt; ARB &gt; Waveform Segment or [IQ] &gt; ARB &gt; Waveform Sequence</code> , reps: 1 ~ 65535, marker: NONE  M1  M2  M3  M4  M1M2  M1M3  M1M4  M2M3  M2M4  M3M4  M1M2M3  M1M2M4  M1M3M4  M2M3M4  ALL
<b>RETURN</b>	String
<b>DEFAULT VALUE</b>	None
<b>EQUIVALENT MENU</b>	<code>[IQ] &gt; ARB &gt; Waveform Sequence &gt; Build</code>
<b>EXAMPLE</b>	<code>:RADio:ARB:SEquence "SEQ:Test_Data","WFM:ramp_wave",25,M1M4,"WFM:sine_wave",100,ALL,"SEQ:seq1",3,NONE :RADio:ARB:SEquence? "SEQ:Test_Data" Return: "WFM:ramp_wave",25,M1M4,"WFM:sine_wave",100,ALL,"SEQ:seq1",3,NONE\n</code>

**3.4.14.11 Sample Clock ([:SOURce]:RADio:ARB:SClock:RATE)**

<b>SYNTAX</b>	<code>[:SOURce]:RADio:ARB:SClock:RATE &lt;rate&gt; [:SOURce]:RADio:ARB:SClock:RATE?</code>
<b>DESCRIPTION</b>	This command sets/queries the sample clock rate of ARB modulation.
<b>DATA TYPE</b>	Float, unit: Hz, kHz, MHz or GHz, default is Hz
<b>RANGE</b>	0.002 Hz ~ 240 MHz
<b>RETURN</b>	Float, unit: Hz
<b>DEFAULT VALUE</b>	2 MHz
<b>EQUIVALENT MENU</b>	<code>[IQ] &gt; ARB &gt; ARB Setup &gt; Sample Clock</code>
<b>EXAMPLE</b>	<code>:RADio:ARB:SClock:RATE 4 MHz :RADio:ARB:SClock:RATE? Return: 4000000\n</code>

**3.4.14.12 Modulator Atten Type ([:SOURce]:RADio:ARB:IQ:MODulation:ATTen:AUTO)**

<b>SYNTAX</b>	<code>[:SOURce]:RADio:ARB:IQ:MODulation:ATTen:AUTO AUTO MANUal</code> <code>[:SOURce]:RADio:ARB:IQ:MODulation:ATTen:AUTO?</code>
<b>DESCRIPTION</b>	This command sets/queries the attenuation type of the ARB modulator.
<b>DATA TYPE</b>	Enumeration
<b>RANGE</b>	AUTO MANUal
<b>RETURN</b>	Enumeration
<b>DEFAULT VALUE</b>	AUTO
<b>EQUIVALENT MENU</b>	<b>IQ</b> > ARB > ARB Setup > Modulator Atten Type
<b>EXAMPLE</b>	<code>:RADio:ARB:IQ:MODulation:ATTen:AUTO AUTO</code> <code>:RADio:ARB:IQ:MODulation:ATTen:AUTO?</code> Return: <code>AUTO</code>

**3.4.14.13 Modulation Atten ([:SOURce]:RADio:ARB:IQ:MODulation:ATTen)**

<b>SYNTAX</b>	<code>[:SOURce]:RADio:ARB:IQ:MODulation:ATTen &lt;val&gt;</code> <code>[:SOURce]:RADio:ARB:IQ:MODulation:ATTen?</code>
<b>DESCRIPTION</b>	This command sets/queries the attenuation value of the ARB modulator.
<b>DATA TYPE</b>	Float, unit: dB
<b>RANGE</b>	0 ~ 20
<b>RETURN</b>	Float, unit: dB
<b>DEFAULT VALUE</b>	3
<b>EQUIVALENT MENU</b>	<b>IQ</b> > ARB > ARB Setup > Modulation Atten
<b>EXAMPLE</b>	<code>:RADio:ARB:IQ:MODulation:ATTen 10</code> <code>:RADio:ARB:IQ:MODulation:ATTen?</code> Return: <code>10</code>

**3.4.14.14 Real Time AWGN State ([:SOURce]:RADio:ARB:NOISe[:STATe])**

<b>SYNTAX</b>	<code>[:SOURce]:RADio:ARB:NOISe[:STATe] ON OFF 1 0</code> <code>[:SOURce]:RADio:ARB:NOISe[:STATe]?</code>
<b>DESCRIPTION</b>	This command sets/queries the real-time AWGN switch status of ARB.
<b>DATA TYPE</b>	Boolean
<b>RANGE</b>	ON OFF 1 0
<b>RETURN</b>	1 0
<b>DEFAULT VALUE</b>	0
<b>EQUIVALENT MENU</b>	<b>IQ</b> > ARB > ARB Setup > Real Time AWGN

---

**EXAMPLE**                    :*RADio:ARB:NOISe 1*  
                                   :*RADio:ARB:NOISe?*  
 Return:  
                                   1\n

---

#### 3.4.14.15 Output Mux ([:SOURce]:RADio:ARB:NOISe:OUTPut)

---

<b>SYNTAX</b>	<i>[:SOURce]:RADio:ARB:NOISe:OUTPut CARRier NOISe CARRier_NOISe [:SOURce]:RADio:ARB:NOISe:OUTPut?</i>
<b>DESCRIPTION</b>	This command sets/queries the output type of ARB real-time AWGN.
<b>DATA TYPE</b>	Enumeration
<b>RANGE</b>	CARRier NOISe CARRier_NOISe
<b>RETURN</b>	Enumeration
<b>DEFAULT VALUE</b>	CARRier_NOISe
<b>EQUIVALENT MENU</b>	<b>IQ</b> > ARB > ARB Setup > Real Time AWGN > Output Mux
<b>EXAMPLE</b>	<i>:RADio:ARB:NOISe:OUTPut CARRier</i> <i>:RADio:ARB:NOISe:OUTPut?</i> Return: <i>CARRier\n</i>

---

#### 3.4.14.16 Power Control ([:SOURce]:RADio:ARB:NOISe:POWER:TYPE)

---

<b>SYNTAX</b>	<i>[:SOURce]:RADio:ARB:NOISe:POWER:TYPE CARRier CHNO TONO TOPO [:SOURce]:RADio:ARB:NOISe:POWER:TYPE?</i>
<b>DESCRIPTION</b>	This command sets/queries the power control mode of ARB real-time AWGN.
<b>DATA TYPE</b>	Enumeration
<b>RANGE</b>	CARRier CHNO TONO TOPO
<b>RETURN</b>	Enumeration
<b>DEFAULT VALUE</b>	TOPO
<b>EQUIVALENT MENU</b>	<b>IQ</b> > ARB > ARB Setup > Real Time AWGN > Power Control
<b>EXAMPLE</b>	<i>:RADio:ARB:NOISe:POWER:TYPE CARRier</i> <i>:RADio:ARB:NOISe:POWER:TYPE?</i> Return: <i>CARRier\n</i>

---

#### 3.4.14.17 Total Power ([:SOURce]:RADio:ARB:NOISe:POWER:TOTAL)

---

<b>SYNTAX</b>	<i>[:SOURce]:RADio:ARB:NOISe:POWER:TOTAL &lt;power&gt; [:SOURce]:RADio:ARB:NOISe:POWER:TOTAL?</i>
<b>DESCRIPTION</b>	This command sets/queries the total power value of ARB real-time AWGN.

---

<b>DATA TYPE</b>	Float, unit: dBm
<b>RANGE</b>	-140 ~ 10
<b>RETURN</b>	Float, unit: dBm
<b>DEFAULT VALUE</b>	0
<b>EQUIVALENT MENU</b>	<b>IQ</b> > ARB > ARB Setup > Real Time AWGN > Total Power
<b>EXAMPLE</b>	<i>:RADio:ARB:NOISe:POWeR:TOTAL 0 dBm</i> <i>:RADio:ARB:NOISe:POWeR:TOTAL?</i> Return: <i>0</i>

#### 3.4.14.18 Carrier Power ([:SOURce]:RADio:ARB:NOISe:POWeR:CARRier)

<b>SYNTAX</b>	<i>[:SOURce]:RADio:ARB:NOISe:POWeR:CARRier &lt;power&gt;</i> <i>[:SOURce]:RADio:ARB:NOISe:POWeR:CARRier?</i>
<b>DESCRIPTION</b>	This command sets/queries the carrier power value of ARB real-time AWGN.
<b>DATA TYPE</b>	Float, unit: dBm
<b>RANGE</b>	Related to the total power value of real-time AWGN
<b>RETURN</b>	Float, unit: dBm
<b>DEFAULT VALUE</b>	-3.27
<b>EQUIVALENT MENU</b>	<b>IQ</b> > ARB > ARB Setup > Real Time AWGN > Carrier Power
<b>EXAMPLE</b>	<i>:RADio:ARB:NOISe:POWeR:CARRier 0 dBm</i> <i>:RADio:ARB:NOISe:POWeR:CARRier?</i> Return: <i>0</i>

#### 3.4.14.19 Total Noise Power ([:SOURce]:RADio:ARB:NOISe:POWeR:TONOise)

<b>SYNTAX</b>	<i>[:SOURce]:RADio:ARB:NOISe:POWeR:TONOise &lt;power&gt;</i> <i>[:SOURce]:RADio:ARB:NOISe:POWeR:TONOise?</i>
<b>DESCRIPTION</b>	This command sets/queries the total noise power value of ARB real-time AWGN.
<b>DATA TYPE</b>	Float, unit: dBm
<b>RANGE</b>	Related to the total power value of real-time AWGN
<b>RETURN</b>	Float, unit: dBm
<b>DEFAULT VALUE</b>	-3.27
<b>EQUIVALENT MENU</b>	<b>IQ</b> > ARB > ARB Setup > Real Time AWGN > Total Noise Power
<b>EXAMPLE</b>	<i>:RADio:ARB:NOISe:POWeR:TONOise 0 dBm</i> <i>:RADio:ARB:NOISe:POWeR:TONOise?</i> Return: <i>0</i>

#### 3.4.14.20 Channel Noise Power ([:SOURce]:RADio:ARB:NOISe:POWer:CHNOise)

<b>SYNTAX</b>	<code>[:SOURce]:RADio:ARB:NOISe:POWer:CHNOise &lt;power&gt;</code> <code>[:SOURce]:RADio:ARB:NOISe:POWer:CHNOise?</code>
<b>DESCRIPTION</b>	This command sets/queries the channel noise power value of ARB real-time AWGN.
<b>DATA TYPE</b>	Float, unit: dBm
<b>RANGE</b>	Related to the total power value of real-time AWGN
<b>RETURN</b>	Float, unit: dBm
<b>DEFAULT VALUE</b>	-3.27
<b>EQUIVALENT MENU</b>	<b>IQ</b> > ARB > ARB Setup > Real Time AWGN > Channel Noise Power
<b>EXAMPLE</b>	<code>:RADio:ARB:NOISe:POWer:CHNOise 0 dBm</code> <code>:RADio:ARB:NOISe:POWer:CHNOise?</code> Return: <code>0\n</code>

#### 3.4.14.21 Carrier To Noise Ratio Format ([:SOURce]:RADio:ARB:NOISe:CN:FORMat)

<b>SYNTAX</b>	<code>[:SOURce]:RADio:ARB:NOISe:CN:FORMat CARRier BIT</code> <code>[:SOURce]:RADio:ARB:NOISe:CN:FORMat?</code>
<b>DESCRIPTION</b>	This command sets/queries the carrier-to-noise ratio format of ARB real-time AWGN.
<b>DATA TYPE</b>	Enumeration
<b>RANGE</b>	CARRier BIT
<b>RETURN</b>	Enumeration
<b>DEFAULT VALUE</b>	CARRier
<b>EQUIVALENT MENU</b>	<b>IQ</b> > ARB > ARB Setup > Real Time AWGN > Carrier To Noise Ratio Format
<b>EXAMPLE</b>	<code>:RADio:ARB:NOISe:CN:FORMat BIT</code> <code>:RADio:ARB:NOISe:CN:FORMat?</code> Return: <code>BIT\n</code>

#### 3.4.14.22 Carrier To Noise Ratio ([:SOURce]:RADio:ARB:NOISe:CN)

<b>SYNTAX</b>	<code>[:SOURce]:RADio:ARB:NOISe:CN &lt;val&gt;</code> <code>[:SOURce]:RADio:ARB:NOISe:CN?</code>
<b>DESCRIPTION</b>	This command sets/queries the carrier-to-noise ratio of the ARB real-time AWGN.
<b>DATA TYPE</b>	Float, unit: dB
<b>RANGE</b>	-100 ~ 100
<b>RETURN</b>	Float, unit: dB
<b>DEFAULT VALUE</b>	0

<b>EQUIVALENT MENU</b>	<b>IQ</b> > ARB > ARB Setup > Real Time AWGN > Carrier To Noise Ratio
<b>EXAMPLE</b>	<code>:RADio:ARB:NOISe:CN -5</code> <code>:RADio:ARB:NOISe:CN?</code> Return: <code>-5\n</code>

#### 3.4.14.23 Bit To Noise Ratio ([:SOURce]:RADio:ARB:NOISe:CBNO)

<b>SYNTAX</b>	<code>[:SOURce]:RADio:ARB:NOISe:CBNO &lt;val&gt;</code> <code>[:SOURce]:RADio:ARB:NOISe:CBNO?</code>
<b>DESCRIPTION</b>	This command sets/queries the bit signal-to-noise ratio of ARB real-time AWGN.
<b>DATA TYPE</b>	Float, unit: dB
<b>RANGE</b>	Relevant to the values of carrier signal-to-noise ratio and carrier bit rate.
<b>RETURN</b>	Float, unit: dB
<b>DEFAULT VALUE</b>	0
<b>EQUIVALENT MENU</b>	<b>IQ</b> > ARB > ARB Setup > Real Time AWGN > Eb/No
<b>EXAMPLE</b>	<code>:RADio:ARB:NOISe:CBNO -5</code> <code>:RADio:ARB:NOISe:CBNO?</code> Return: <code>-5\n</code>

#### 3.4.14.24 Carrier Bit Rate ([:SOURce]:RADio:ARB:NOISe:BRATe)

<b>SYNTAX</b>	<code>[:SOURce]:RADio:ARB:NOISe:BRATe &lt;rate&gt;</code> <code>[:SOURce]:RADio:ARB:NOISe:BRATe?</code>
<b>DESCRIPTION</b>	This command sets/queries the carrier bit rate of ARB real-time AWGN.
<b>DATA TYPE</b>	Float, unit: Sps
<b>RANGE</b>	1 ~ 10*Carrier Bandwidth
<b>RETURN</b>	Float, unit: Sps
<b>DEFAULT VALUE</b>	1
<b>EQUIVALENT MENU</b>	<b>IQ</b> > ARB > ARB Setup > Real Time AWGN > Carrier Bit Rate
<b>EXAMPLE</b>	<code>:RADio:ARB:NOISe:BRATe 5</code> <code>:RADio:ARB:NOISe:BRATe?</code> Return: <code>5\n</code>

#### 3.4.14.25 Carrier Bandwidth ([:SOURce]:RADio:ARB:NOISe:CBWidth)

<b>SYNTAX</b>	<code>[:SOURce]:RADio:ARB:NOISe:CBWidth &lt;bandwidth&gt;</code> <code>[:SOURce]:RADio:ARB:NOISe:CBWidth?</code>
---------------	---

<b>DESCRIPTION</b>	This command sets/queries the carrier bandwidth of ARB real-time AWGN.
<b>DATA TYPE</b>	Float, unit: Hz
<b>RANGE</b>	1 Hz ~ 120 MHz
<b>RETURN</b>	Float, unit: Hz
<b>DEFAULT VALUE</b>	1 Hz
<b>EQUIVALENT MENU</b>	<b>IQ</b> > ARB > ARB Setup > Real Time AWGN > Carrier Bandwidth
<b>EXAMPLE</b>	<i>:RADio:ARB:NOISe:CBWidth 5000000</i> <i>:RADio:ARB:NOISe:CBWidth?</i> Return: <i>5000000\n</i>

#### 3.4.14.26 Flat Noise Bandwidth ([:SOURce]:RADio:ARB:NOISe:NBWidth)

<b>SYNTAX</b>	<i>[:SOURce]:RADio:ARB:NOISe:NBWidth &lt;bandwidth&gt;</i> <i>[:SOURce]:RADio:ARB:NOISe:NBWidth?</i>
<b>DESCRIPTION</b>	This command sets/queries the flat noise bandwidth of ARB real-time AWGN.
<b>DATA TYPE</b>	Float, unit: Hz
<b>RANGE</b>	Carrier Bandwidth ~ 120 MHz
<b>RETURN</b>	Float, unit: Hz
<b>DEFAULT VALUE</b>	1 Hz
<b>EQUIVALENT MENU</b>	<b>IQ</b> > ARB > ARB Setup > Real Time AWGN > Flat Noise Bandwidth
<b>EXAMPLE</b>	<i>:RADio:ARB:NOISe:NBWidth 5000000</i> <i>:RADio:ARB:NOISe:NBWidth?</i> Return: <i>5000000\n</i>

#### 3.4.14.27 ARB Filter Type ([:SOURce]:IQ:DUALarb:FILTer:TYPE)

<b>SYNTAX</b>	<i>[:SOURce]:IQ:DUALarb:FILTer:TYPE</i> <i>NONE RAISecosine ROOTcosine GAUSSian HSINe</i> <i>[:SOURce]:IQ:DUALarb:FILTer:TYPE?</i>
<b>DESCRIPTION</b>	This command sets/queries the filter type of ARB modulation.
<b>DATA TYPE</b>	Enumeration
<b>RANGE</b>	<i>NONE RAISecosine ROOTcosine GAUSSian HSINe</i>
<b>RETURN</b>	Enumeration
<b>DEFAULT VALUE</b>	NONE
<b>EQUIVALENT MENU</b>	<b>IQ</b> > ARB > ARB Setup > Modulation Filter > Filter Type
<b>EXAMPLE</b>	<i>:IQ:DUALarb:FILTer:TYPE GAUSSian</i> <i>:IQ:DUALarb:FILTer:TYPE?</i> Return: <i>GAUSSian\n</i>

**3.4.14.28 ARB Filter Alpha/BT ([:SOURce]:IQ:DUALarb:FILTer:ALPHa)**

<b>SYNTAX</b>	<code>[:SOURce]:IQ:DUALarb:FILTer:ALPHa &lt;val&gt;</code> <code>[:SOURce]:IQ:DUALarb:FILTer:ALPHa?</code>
<b>DESCRIPTION</b>	This command sets/queries the alpha value of a Nyquist or root Nyquist filter or the BT value of a Gaussian filter of the ARB modulation.
<b>DATA TYPE</b>	Float
<b>RANGE</b>	0.010 ~ 1.000
<b>RETURN</b>	Float
<b>DEFAULT VALUE</b>	0.500
<b>EQUIVALENT MENU</b>	<b>IQ</b> > ARB > ARB Setup > Modulation Filter > Filter Alpha/BT
<b>EXAMPLE</b>	<code>:IQ:DUALarb:FILTer:ALPHa 0.22</code> <code>:IQ:DUALarb:FILTer:ALPHa?</code> Return: <code>0.22</code>

**3.4.14.29 ARB Filter Length ([:SOURce]:IQ:DUALarb:FILTer:LENGth)**

<b>SYNTAX</b>	<code>[:SOURce]:IQ:DUALarb:FILTer:LENGth &lt;len&gt;</code> <code>[:SOURce]:IQ:DUALarb:FILTer:LENGth?</code>
<b>DESCRIPTION</b>	This command sets/queries the filter length of ARB modulation.
<b>DATA TYPE</b>	Integer
<b>RANGE</b>	1 ~ 512
<b>RETURN</b>	Integer
<b>DEFAULT VALUE</b>	32
<b>EQUIVALENT MENU</b>	<b>IQ</b> > ARB > ARB Setup > Modulation Filter > Filter Length
<b>EXAMPLE</b>	<code>:IQ:DUALarb:FILTer:LENGth 64</code> <code>:IQ:DUALarb:FILTer:LENGth?</code> Return: <code>64</code>

**3.4.14.30 ARB Filter OverSampling ([:SOURce]:IQ:DUALarb:OSAMple)**

<b>SYNTAX</b>	<code>[:SOURce]:IQ:DUALarb:OSAMple &lt;val&gt;</code> <code>[:SOURce]:IQ:DUALarb:OSAMple?</code>
<b>DESCRIPTION</b>	This command sets/queries the oversampling value of the ARB modulation filter.
<b>DATA TYPE</b>	Integer
<b>RANGE</b>	2 ~ 32
<b>RETURN</b>	Integer
<b>DEFAULT VALUE</b>	2
<b>EQUIVALENT MENU</b>	<b>IQ</b> > ARB > ARB Setup > Modulation Filter > OverSampling



---

**EXAMPLE**                    *:IQ:DUALarb:OSAMple 4*  
                                   *:IQ:DUALarb:OSAMple?*  
 Return:  
*4\n*

---

#### 3.4.14.31 ARB Filter Update ([:SOURce]:IQ:DUALarb:FILTer:UPDAte)

---

<b>SYNTAX</b>	<code>[:SOURce]:IQ:DUALarb:FILTer:UPDAte</code>
<b>DESCRIPTION</b>	This command updates the settings of the ARB filter.
<b>EQUIVALENT MENU</b>	<code>[IQ]</code> > ARB > ARB Setup > Modulation Filter > Update
<b>EXAMPLE</b>	<i>:IQ:DUALarb:FILTer:UPDAte</i>

---

#### 3.4.14.32 Baseband Offset State ([:SOURce]:RADio:ARB:OFFSet:STATe)

---

<b>SYNTAX</b>	<code>[:SOURce]:RADio:ARB:OFFSet:STATe ON OFF 1 0</code> <code>[:SOURce]:RADio:ARB:OFFSet:STATe?</code>
<b>DESCRIPTION</b>	This command sets/queries the switch status of ARB baseband frequency offset.
<b>DATA TYPE</b>	Boolean
<b>RANGE</b>	ON OFF 1 0
<b>RETURN</b>	1 0
<b>DEFAULT VALUE</b>	0
<b>EQUIVALENT MENU</b>	<code>[IQ]</code> > ARB > ARB Setup > Baseband Offset
<b>EXAMPLE</b>	<i>:RADio:ARB:OFFSet:STATe 1</i> <i>:RADio:ARB:OFFSet:STATe?</i> Return: <i>1\n</i>

---

#### 3.4.14.33 Baseband Offset Freq ([:SOURce]:RADio:ARB:OFFSet:FREQuency)

---

<b>SYNTAX</b>	<code>[:SOURce]:RADio:ARB:OFFSet:FREQuency &lt;freq&gt;</code> <code>[:SOURce]:RADio:ARB:OFFSet:FREQuency?</code>
<b>DESCRIPTION</b>	This command sets/queries the baseband offset frequency of ARB modulation.
<b>DATA TYPE</b>	Float, unit: Hz
<b>RANGE</b>	0 Hz ~ 60 MHz
<b>RETURN</b>	Float, unit: Hz
<b>DEFAULT VALUE</b>	0 Hz
<b>EQUIVALENT MENU</b>	<code>[IQ]</code> > ARB > ARB Setup > Baseband Offset(On) > Offset Freq
<b>EXAMPLE</b>	<i>:RADio:ARB:OFFSet:FREQuency -1000000</i> <i>:RADio:ARB:OFFSet:FREQuency?</i> Return: <i>-1000000\n</i>

---

**3.4.14.34 Set Active Marker ([:SOURce]:IQ:DUALarb:MARKer)**

<b>SYNTAX</b>	<code>[:SOURce]:IQ:DUALarb:MARKer &lt;marker&gt;</code> <code>[:SOURce]:IQ:DUALarb:MARKer?</code>
<b>DESCRIPTION</b>	This command selects/queries the active marker to edit.
<b>DATA TYPE</b>	Integer
<b>RANGE</b>	1 ~ 4
<b>EQUIVALENT MENU</b>	<b>IQ</b> > ARB > Marker Utilities > Marker Number
<b>EXAMPLE</b>	<code>:IQ:DUALarb:MARKer 2</code> <code>:IQ:DUALarb:MARKer?</code> Return: <code>2</code>

**3.4.14.35 Set Markers ([:SOURce]:RADio:ARB:MARKer:[SET])**

<b>SYNTAX</b>	<code>[:SOURce]:RADio:ARB:MARKer:[SET]</code> <code>&lt;"segment"&gt;,&lt;index&gt;,&lt;first_point&gt;,&lt;last_point&gt;,&lt;skip_count&gt;</code>
<b>DESCRIPTION</b>	This command sets the identification point of an ARB waveform segment.
<b>DATA TYPE</b>	segment: string, waveform segment name, index: integer, first_point: integer, marking the first identification point of the waveform segment, last_point: integer, marking the last identification point of the waveform segment, skip_count: integer, marking the interval between identification points of the waveform segment.
<b>RANGE</b>	segment: waveform segment in the ARB segment list, index: 1 ~ 1024, first_point: 1 ~ the number of points in the waveform segment, last_point: <first_point> ~ the number of points in the waveform segment, skip_count: 0 ~ (<last_point> - <first_point>)
<b>EQUIVALENT MENU</b>	<b>IQ</b> > ARB > Marker Utilities > Set Markers
<b>EXAMPLE</b>	<code>:RADio:ARB:MARKer:CLEar:ALL "RAMP_WAVE",2</code> <code>:IQ:DUALarb:MARKer 2</code> <code>:RADio:ARB:MARKer "RAMP_WAVE",1,10,20,5</code> <code>:RADio:ARB:MARKer "RAMP_WAVE",2,100,150,0</code>  At this time, the identifier of RAMP_WAVE is: 10,20,5\n100,150,0

**3.4.14.36 Clear Marker ([:SOURce]:RADio:ARB:MARKer:CLEar:ALL)**

<b>SYNTAX</b>	<code>[:SOURce]:RADio:ARB:MARKer:CLEar:ALL &lt;"segment"&gt;,&lt;marker&gt;</code>
<b>DESCRIPTION</b>	This command clears the identification of the specified identification point of the waveform segment.
<b>DATA TYPE</b>	segment: string, waveform segment name, marker: integer, identification point.

<b>RANGE</b>	segment: waveform segment in the ARB segment list, marker: 1 ~ 4.
<b>EQUIVALENT MENU</b>	<input type="text" value="IQ"/> > ARB > Marker Utilities > Set Markers > Clear
<b>EXAMPLE</b>	<i>:RADio:ARB:MARKer:CLEar:ALL "SINE_WAVE",1</i>

#### 3.4.14.37 Marker Polarity ([:SOURce]:RADio:ARB:MPOLarity:MARKer1|2|3|4)

<b>SYNTAX</b>	[:SOURce]:RADio:ARB:MPOLarity:MARKer1 2 3 4 NEG POS [:SOURce]:RADio:ARB:MPOLarity:MARKer1 2 3 4?
<b>DESCRIPTION</b>	This command sets/queries the polarity of the specified identification point.
<b>DATA TYPE</b>	Enumeration
<b>RANGE</b>	NEG POS
<b>RETURN</b>	Enumeration
<b>DEFAULT VALUE</b>	NEG
<b>EQUIVALENT MENU</b>	<input type="text" value="IQ"/> > ARB > Marker Utilities > Marker Polarity
<b>EXAMPLE</b>	<i>:RADio:ARB:MPOLarity:MARKer1 NEG</i> <i>:RADio:ARB:MPOLarity:MARKer1?</i> Return: <i>NEG\n</i>

#### 3.4.14.38 Marker Output ([:SOURce]:RADio:ARB:MARKer:OUTPut)

<b>SYNTAX</b>	[:SOURce]:RADio:ARB:MARKer:OUTPut None Marker1 Marker2 Marker3 Marker4 [:SOURce]:RADio:ARB:MARKer:OUTPut?
<b>DESCRIPTION</b>	This command sets/queries the output identification point of the ARB waveform segment.
<b>DATA TYPE</b>	Enumeration
<b>RANGE</b>	None Marker1 Marker2 Marker3 Marker4
<b>RETURN</b>	Enumeration
<b>DEFAULT VALUE</b>	Marker1
<b>EQUIVALENT MENU</b>	<input type="text" value="IQ"/> > ARB > Marker Utilities > Marker Output
<b>EXAMPLE</b>	<i>:RADio:ARB:MARKer:OUTPut Marker2</i> <i>:RADio:ARB:MARKer:OUTPut?</i> Return: <i>Marker2\n</i>

#### 3.4.14.39 Marker Delay ([:SOURce]:IQ:DUALarb:MARKer:DELAy)

<b>SYNTAX</b>	[:SOURce]:IQ:DUALarb:MARKer:DELAy <time> [:SOURce]:IQ:DUALarb:MARKer:DELAy?
<b>DESCRIPTION</b>	This command sets/queries the identification delay time of the waveform segment.

<b>DATA TYPE</b>	Float, unit: ns, us, ms or s, default is s
<b>RANGE</b>	-4 us ~ 860 us
<b>RETURN</b>	Float, unit: s
<b>DEFAULT VALUE</b>	0
<b>EQUIVALENT MENU</b>	<b>IQ</b> > ARB > Marker Utilities > Marker Delay
<b>EXAMPLE</b>	<i>:IQ:DUALarb:MARKer:DELAy 20 us</i> <i>:IQ:DUALarb:MARKer:DELAy?</i> Return: <i>2e-05\n</i>

#### 3.4.14.40 Pulse/RF Blank ([:SOURce]:RADio:ARB:MDEStination:PULSe)

<b>SYNTAX</b>	<code>[:SOURce]:RADio:ARB:MDEStination:PULSe</code> None Marker1 Marker2 Marker3 Marker4 <code>[:SOURce]:RADio:ARB:MDEStination:PULSe?</code>
<b>DESCRIPTION</b>	This command sets/queries the marker pulse/RF blanking function of the waveform segment.
<b>DATA TYPE</b>	Enumeration
<b>RANGE</b>	None Marker1 Marker2 Marker3 Marker4
<b>RETURN</b>	Enumeration
<b>DEFAULT VALUE</b>	None
<b>EQUIVALENT MENU</b>	<b>IQ</b> > ARB > Marker Utilities > Pulse/RF Blank
<b>EXAMPLE</b>	<i>:RADio:ARB:MDEStination:PULSe Marker2</i> <i>:RADio:ARB:MDEStination:PULSe?</i> Return: <i>Marker2\n</i>

#### 3.4.14.41 Clipping ([:SOURce]:RADio:ARB:CLIPping)

<b>SYNTAX</b>	<code>[:SOURce]:RADio:ARB:CLIPping</code> <"segment">,I Q IORQ,<val>[,<val>]
<b>DESCRIPTION</b>	This command sets the clipping level of the selected waveform segment to a percentage of its highest peak.
<b>DATA TYPE</b>	segment: string, waveform segment name, I Q IORQ: enumeration, reduction type,  I+jQ  or   , Q , val: float, reduction coefficient.
<b>RANGE</b>	segment: waveform segment in the ARB segment list, I Q IORQ: I Q  represents  I+jQ , IORQ represents   ,  Q , val: 0.01~1.
<b>EQUIVALENT MENU</b>	<b>IQ</b> > ARB > Waveform Utilities > Select Segment & Clip  I+jQ  to / Clip    to / Clip  Q  to
<b>EXAMPLE</b>	<i>:RADio:ARB:CLIPping "SINE_WAVE",I Q,0.75</i> <i>:RADio:ARB:CLIPping "RAMP_WAVE",IORQ,0.75,0.8</i>

**3.4.14.42 Scaling ([:SOURce]:RADio:ARB:SCaling)**

<b>SYNTAX</b>	<code>[:SOURce]:RADio:ARB:SCaling &lt;"segment"&gt;,&lt;val&gt;</code>
<b>DESCRIPTION</b>	This command scales the specified waveform segment.
<b>DATA TYPE</b>	segment: string, waveform segment name, val: float, scaling factor.
<b>RANGE</b>	segment: waveform segment in the ARB segment list, val: 0.01~1.
<b>EQUIVALENT MENU</b>	<code>IQ</code> > ARB > Waveform Utilities > Select Segment & Scaling
<b>EXAMPLE</b>	<code>:RADio:ARB:Scaling "RAMP_WAVE",0.75</code>

**3.4.14.43 ARB Trigger Type ([:SOURce]:IQ:DUALarb:TRIGger:TYPE)**

<b>SYNTAX</b>	<code>[:SOURce]:IQ:DUALarb:TRIGger:TYPE CONTInous  SINGle  SADVance  GATE</code> <code>[:SOURce]:IQ:DUALarb:TRIGger:TYPE?</code>
<b>DESCRIPTION</b>	This command sets/queries the trigger type of ARB.
<b>DATA TYPE</b>	Enumeration
<b>RANGE</b>	CONTInous  SINGle  SADVance  GATE
<b>RETURN</b>	Enumeration
<b>DEFAULT VALUE</b>	CONTInous
<b>EQUIVALENT MENU</b>	<code>IQ</code> > ARB > Trigger > Trigger Type
<b>EXAMPLE</b>	<code>:IQ:DUALarb:TRIGger:TYPE SINGle</code> <code>:IQ:DUALarb:TRIGger:TYPE?</code> Return: <code>SINGle</code>

**3.4.14.44 ARB Trigger Continuous Mode ([:SOURce]:IQ:DUALarb:TRIGger:CONTInous)**

<b>SYNTAX</b>	<code>[:SOURce]:IQ:DUALarb:TRIGger:CONTInous FREErun   RUNIgnored   RUNRestart</code> <code>[:SOURce]:IQ:DUALarb:TRIGger:CONTInous?</code>
<b>DESCRIPTION</b>	This command sets/queries the trigger mode of ARB continuous trigger.
<b>DATA TYPE</b>	Enumeration
<b>RANGE</b>	FREErun   RUNIgnored   RUNRestart
<b>RETURN</b>	Enumeration
<b>DEFAULT VALUE</b>	FREErun
<b>EQUIVALENT MENU</b>	<code>IQ</code> > ARB > Trigger > Trigger Type(Continuous) > Continuous Mode
<b>EXAMPLE</b>	<code>:IQ:DUALarb:TRIGger:CONTInous RUNIgnored</code> <code>:IQ:DUALarb:TRIGger:CONTInous?</code> Return: <code>RUNIgnored</code>

**3.4.14.45 ARB Trigger Single Mode ([:SOURce]:IQ:DUALarb:TRIGger:SINGLE)**

<b>SYNTAX</b>	[:SOURce]:IQ:DUALarb:TRIGger:SINGLE NOREtrigger   BUFFeredtrig   REStartontrig [:SOURce]:IQ:DUALarb:TRIGger:SINGLE?
<b>DESCRIPTION</b>	This command sets/queries the trigger mode of ARB single trigger.
<b>DATA TYPE</b>	Enumeration
<b>RANGE</b>	NOREtrigger   BUFFeredtrig   REStartontrig
<b>RETURN</b>	Enumeration
<b>DEFAULT VALUE</b>	NOREtrigger
<b>EQUIVALENT MENU</b>	<b>IQ</b> > ARB > Trigger > Trigger Type(Single) > Single Mode
<b>EXAMPLE</b>	<i>:IQ:DUALarb:TRIGger:SINGLE BUFFeredtrig</i> <i>:IQ:DUALarb:TRIGger:SINGLE?</i> Return: <i>BUFFeredtrig</i>

**3.4.14.46 ARB Trigger Segment Mode ([:SOURce]:IQ:DUALarb:TRIGger:SEGMENT)**

<b>SYNTAX</b>	[:SOURce]:IQ:DUALarb:TRIGger:SEGMENT SINGLE   CONTInous [:SOURce]:IQ:DUALarb:TRIGger:SEGMENT?
<b>DESCRIPTION</b>	This command sets/queries the trigger mode of ARB segment triggered in advance.
<b>DATA TYPE</b>	Enumeration
<b>RANGE</b>	SINGLE   CONTInous
<b>RETURN</b>	Enumeration
<b>DEFAULT VALUE</b>	CONTInous
<b>EQUIVALENT MENU</b>	<b>IQ</b> > ARB > Trigger > Trigger Type(Segment Advance) > Segment Mode
<b>EXAMPLE</b>	<i>:IQ:DUALarb:TRIGger:SEGMENT SINGLE</i> <i>:IQ:DUALarb:TRIGger:SEGMENT?</i> Return: <i>SINGLE</i>

**3.4.14.47 ARB Trigger Gate Mode ([:SOURce]:IQ:DUALarb:TRIGger:GATE)**

<b>SYNTAX</b>	[:SOURce]:IQ:DUALarb:TRIGger:GATE LOW   HIGH [:SOURce]:IQ:DUALarb:TRIGger:GATE?
<b>DESCRIPTION</b>	This command sets/queries the trigger mode of ARB external gating trigger.
<b>DATA TYPE</b>	Enumeration
<b>RANGE</b>	LOW   HIGH
<b>RETURN</b>	Enumeration
<b>DEFAULT VALUE</b>	HIGH

<b>EQUIVALENT MENU</b>	<code>[IQ] &gt; ARB &gt; Trigger &gt; Trigger Type(Ext Gated) &gt; Gate Mode</code>
<b>EXAMPLE</b>	<code>:IQ:DUALarb:TRIGger:GATE LOW</code> <code>:IQ:DUALarb:TRIGger:GATE?</code> Return: <code>LOWn</code>

#### 3.4.14.48 ARB Trigger Source ([:SOURce]:IQ:DUALarb:TRIGger:SOURce)

<b>SYNTAX</b>	<code>[:SOURce]:IQ:DUALarb:TRIGger:SOURce KEY  BUS  EXT</code> <code>[:SOURce]:IQ:DUALarb:TRIGger:SOURce?</code>
<b>DESCRIPTION</b>	This command sets/queries the trigger source of ARB trigger.
<b>DATA TYPE</b>	Enumeration
<b>RANGE</b>	KEY  BUS  EXT
<b>RETURN</b>	Enumeration
<b>DEFAULT VALUE</b>	KEY
<b>EQUIVALENT MENU</b>	<code>[IQ] &gt; ARB &gt; Trigger &gt; Trigger Source</code>
<b>EXAMPLE</b>	<code>:IQ:DUALarb:TRIGger:SOURce EXT</code> <code>:IQ:DUALarb:TRIGger:SOURce?</code> Return: <code>EXTn</code>

#### 3.4.14.49 ARB Bus Trigger ([:SOURce]:IQ:DUALarb:TRG)

<b>SYNTAX</b>	<code>[:SOURce]:IQ:DUALarb:TRG</code>
<b>DESCRIPTION</b>	When the ARB trigger source is Bus, executing this command sends an ARB trigger signal.
<b>EQUIVALENT MENU</b>	None
<b>EXAMPLE</b>	<code>:IQ:DUALarb:TRG</code>

#### 3.4.14.50 ARB Trigger Polarity ([:SOURce]:IQ:DUALarb:TRIGger:POL)

<b>SYNTAX</b>	<code>[:SOURce]:IQ:DUALarb:TRIGger:POL POS   NEG</code> <code>[:SOURce]:IQ:DUALarb:TRIGger:POL?</code>
<b>DESCRIPTION</b>	This command sets/queries the trigger polarity of ARB external trigger.
<b>DATA TYPE</b>	Enumeration
<b>RANGE</b>	POS   NEG
<b>RETURN</b>	Enumeration
<b>DEFAULT VALUE</b>	POS
<b>EQUIVALENT MENU</b>	<code>[IQ] &gt; ARB &gt; Trigger &gt; Trigger Source(Ext) &gt; Ext Polarity</code>
<b>EXAMPLE</b>	<code>:IQ:DUALarb:TRIGger:POL NEG</code> <code>:IQ:DUALarb:TRIGger:POL?</code>

---

Return:  
NEG\n

---

#### 3.4.14.51 ARB Trigger Delay Type ([:SOURce]:IQ:DUALarb:TRIGger:DELAy:TYPE)

<b>SYNTAX</b>	[:SOURce]:IQ:DUALarb:TRIGger:DELAy:TYPE OFF   TIME   SAMPlE [:SOURce]:IQ:DUALarb:TRIGger:DELAy:TYPE?
<b>DESCRIPTION</b>	This command sets/queries the trigger delay type of ARB external trigger.
<b>DATA TYPE</b>	Enumeration
<b>RANGE</b>	OFF   TIME   SAMPlE
<b>RETURN</b>	Enumeration
<b>DEFAULT VALUE</b>	OFF
<b>EQUIVALENT MENU</b>	<span style="border: 1px solid black; padding: 2px;">IQ</span> > ARB > Trigger > Trigger Source(Ext) > Delay Type
<b>EXAMPLE</b>	:IQ:DUALarb:TRIGger:DELAy:TYPE SAMPlE :IQ:DUALarb:TRIGger:DELAy:TYPE? Return: SAMPlE\n

#### 3.4.14.52 ARB Trigger Delay Time ([:SOURce]:IQ:DUALarb:TRIGger:DELAy:Time)

<b>SYNTAX</b>	[:SOURce]:IQ:DUALarb:TRIGger:DELAy:Time <value> [:SOURce]:IQ:DUALarb:TRIGger:DELAy:Time?
<b>DESCRIPTION</b>	This command sets/queries the trigger delay time of ARB external trigger.
<b>DATA TYPE</b>	Float, unit: s
<b>RANGE</b>	0 ~ 40s
<b>RETURN</b>	Float, unit: s
<b>DEFAULT VALUE</b>	0
<b>EQUIVALENT MENU</b>	<span style="border: 1px solid black; padding: 2px;">IQ</span> > ARB > Trigger > Trigger Source(Ext) > Delay Type(Time) > Delay Time
<b>EXAMPLE</b>	:IQ:DUALarb:TRIGger:DELAy:Time 2 :IQ:DUALarb:TRIGger:DELAy:Time? Return: 2\n

#### 3.4.14.53 ARB Trigger Delay Samples ([:SOURce]:IQ:DUALarb:TRIGger:DELAy:SAMPlE)

<b>SYNTAX</b>	[:SOURce]:IQ:DUALarb:TRIGger:DELAy:SAMPlE <value> [:SOURce]:IQ:DUALarb:TRIGger:DELAy:SAMPlE?
<b>DESCRIPTION</b>	This command sets/queries the trigger delay samples of ARB external trigger.
<b>DATA TYPE</b>	Integer



<b>RANGE</b>	0 ~ 1000000000
<b>RETURN</b>	Integer
<b>DEFAULT VALUE</b>	0
<b>EQUIVALENT MENU</b>	<b>IQ</b> > ARB > Trigger > Trigger Source(Ext) > Delay Type(Sample) > Delay Samples
<b>EXAMPLE</b>	<i>:IQ:DUALarb:TRIGger:DELAy:SAMPlE 500</i> <i>:IQ:DUALarb:TRIGger:DELAy:SAMPlE?</i> Return: <i>500\n</i>

#### 3.4.14.54 Header Info ([:SOURce]:IQ:DUALarb:HEADer:INFO?)

<b>SYNTAX</b>	[:SOURce]:IQ:DUALarb:HEADer:INFO?
<b>DESCRIPTION</b>	This command is used to query the content of the waveform header file. Before querying the content of the header file, you need to select the waveform to be played.
<b>RETURN</b>	String
<b>DEFAULT VALUE</b>	None
<b>EQUIVALENT MENU</b>	<b>IQ</b> > ARB > Waveform Header
<b>EXAMPLE</b>	<i>:RADio:ARB:WAVeform "WFM:SINE_WAVE"</i> <i>:IQ:DUALarb:HEADer:INFO?</i> Return: <i>discript=</i> <i>sampling rate=Unspecified</i> <i>marker1 polary=Unspecified</i> <i>marker2 polary=Unspecified</i> <i>marker3 polary=Unspecified</i> <i>marker4 polary=Unspecified</i> <i>rf marker=Unspecified</i> <i>output marker=Unspecified</i> <i>atten type=Unspecified</i> <i>atten value=Unspecified</i> <i>noise state=Unspecified</i> <i>noise output=Unspecified</i> <i>noise power control=Unspecified</i> <i>noise total power=Unspecified</i> <i>noise carrier power=Unspecified</i> <i>noise noise power=Unspecified</i> <i>channel noise power=Unspecified</i> <i>carrier to noise ratio format=Unspecified</i> <i>carrier to noise ratio=Unspecified</i> <i>bit to noise ratio=Unspecified</i> <i>carrier bit ratio=Unspecified</i> <i>carrier bandwidth=Unspecified</i> <i>noise bandwidth=Unspecified</i> <i>baseband offset state=Unspecified</i> <i>baseband offset freq=Unspecified\n\n</i>

**3.4.14.55 Clear Header ([:SOURce]:IQ:DUALarb:HEADer:CLEAR)**

<b>SYNTAX</b>	<code>[:SOURce]:IQ:DUALarb:HEADer:CLEAR</code>
<b>DESCRIPTION</b>	This command clears the contents of the header file for a waveform segment or sequence.
<b>EQUIVALENT MENU</b>	<code>IQ</code> > ARB > Waveform Header > Clear Header
<b>EXAMPLE</b>	<code>:IQ:DUALarb:HEADer:CLEAR</code>

**3.4.14.56 Save To Header ([:SOURce]:IQ:DUALarb:HEADer:STORE)**

<b>SYNTAX</b>	<code>[:SOURce]:IQ:DUALarb:HEADer:STORE</code>
<b>DESCRIPTION</b>	This command saves the header file contents of a waveform segment or sequence.
<b>EQUIVALENT MENU</b>	<code>IQ</code> > ARB > Waveform Header > Save To Header
<b>EXAMPLE</b>	<code>:IQ:DUALarb:HEADer:STORE</code>

**3.4.14.57 Describe ([:SOURce]:IQ:DUALarb:HEADer:DESCRipt)**

<b>SYNTAX</b>	<code>[:SOURce]:IQ:DUALarb:HEADer:DESCRipt &lt;"string"&gt;</code> <code>[:SOURce]:IQ:DUALarb:HEADer:DESCRipt?</code>
<b>DESCRIPTION</b>	This command sets/queries the header file description of a waveform segment or sequence.
<b>DATA TYPE</b>	String
<b>RANGE</b>	Please refer to the user manual for naming rules.
<b>RETURN</b>	String
<b>DEFAULT VALUE</b>	No description
<b>EQUIVALENT MENU</b>	<code>IQ</code> > ARB > Waveform Header > Describe
<b>EXAMPLE</b>	<code>:IQ:DUALarb:HEADer:DESCRipt "INFO"</code> <code>:IQ:DUALarb:HEADer:DESCRipt?</code> Return: <code>INFO</code>

**3.4.14.58 Multicarrier Waveform Name****([:SOURce]:RADio:DMODulation:ARB:SETup:MCARrier:NAME)**

<b>SYNTAX</b>	<code>[:SOURce]:RADio:DMODulation:ARB:SETup:MCARrier:NAME</code> <code>&lt;"waveform"&gt;</code> <code>[:SOURce]:RADio:DMODulation:ARB:SETup:MCARrier:NAME?</code>
<b>DESCRIPTION</b>	This command sets/queries the waveform name of ARB multi-carrier.
<b>DATA TYPE</b>	String
<b>RANGE</b>	Please refer to the user manual for naming rules.
<b>RETURN</b>	String
<b>DEFAULT VALUE</b>	MULTICARRIER

<b>EQUIVALENT MENU</b>	<code>[IQ] &gt; ARB &gt; Multi Carrier &gt; Waveform Name</code>
<b>EXAMPLE</b>	<pre><code>:RADio:DMODulation:ARB:SETup:MCARrier:NAME "MULTI_TEST" :RADio:DMODulation:ARB:SETup:MCARrier:NAME? Return: MULTI_TEST\n</code></pre>

#### 3.4.14.59 Multicarrier Create and Load ([:SOURce]:RADio:DMODulation:ARB:SETup)

<b>SYNTAX</b>	<code>[:SOURce]:RADio:DMODulation:ARB:SETup</code>
<b>DESCRIPTION</b>	This command can create a multicarrier based on the current settings, then load the multicarrier into an ARB segment and select to play the multicarrier.
<b>EQUIVALENT MENU</b>	<code>[IQ] &gt; ARB &gt; Multi Carrier &gt; Create and Load</code>
<b>EXAMPLE</b>	<code>:RADio:DMODulation:ARB:SETup</code>

#### 3.4.14.60 Multicarrier Assistant ([:SOURce]:RADio:DMODulation:ARB:SETup:MCARrier)

<b>SYNTAX</b>	<pre><code>[:SOURce]:RADio:DMODulation:ARB:SETup:MCARrier &lt;"segment"&gt;,&lt;num&gt;,&lt;freq_space&gt; [:SOURce]:RADio:DMODulation:ARB:SETup:MCARrier?</code></pre>
<b>DESCRIPTION</b>	This command builds a carrier table using the specified number of identical subcarriers and frequency spacing. The query command returns the subcarrier name, subcarrier number and frequency interval of the multi-carrier.
<b>DATA TYPE</b>	<pre>segment: string, num: integer, number of carriers, freq_space: double, frequency interval between carriers, unit: Hz.</pre>
<b>RANGE</b>	<pre>segment: waveform segment in the ARB waveform segment list, num: 2 ~ 100, freq_space: 0 ~ maximum sampling bandwidth/(number of carriers-1).</pre>
<b>RETURN</b>	<pre>String Format: &lt;carrier&gt;,&lt;num carriers&gt;,&lt;freq spacing&gt;</pre>
<b>DEFAULT VALUE</b>	<code>*NONE,2,1000000\n</code>
<b>EQUIVALENT MENU</b>	<code>[IQ] &gt; ARB &gt; Multi Carrier &gt; Carrier Table &gt; Assistant</code>
<b>EXAMPLE</b>	<pre><code>:RADio:DMODulation:ARB:SETup:MCARrier "SINE_WAVE",3,2e6 :RADio:DMODulation:ARB:SETup:MCARrier? Return: SINE_WAVE,3,2000000\n</code></pre>

#### 3.4.14.61 Multicarrier Table ([:SOURce]:RADio:DMODulation:ARB:SETup:MCARrier:TABLE)

<b>SYNTAX</b>	<pre><code>[:SOURce]:RADio:DMODulation:ARB:SETup:MCARrier:TABLE INIT APPend &lt;carrier_num&gt;,&lt;"segment"&gt;,&lt;freq_offset&gt;,&lt;power&gt;,&lt;phase&gt; [:SOURce]:RADio:DMODulation:ARB:SETup:MCARrier:TABLE? &lt;carrier_num&gt;</code></pre>
---------------	--

<b>DESCRIPTION</b>	<p>This command edits the specified row of the ARB multi-carrier list.</p> <p>INIT: This option deletes all multi-carriers and then writes a line of specified carriers,</p> <p>APPend: This option adds a new row of specified carriers after the multi-carrier list.</p> <p>carrier_num: This option modifies the specified row of the multi-carrier list.</p> <p>The query command queries the specified row of the ARB multi-carrier list.</p>
<b>DATA TYPE</b>	<p>INIT APPend: enumeration,</p> <p>carrier_num: integer, carrier number,</p> <p>segment: string,</p> <p>freq_offset: double, offset frequency of the carrier, unit: Hz,</p> <p>power: double, carrier gain, unit: dB,</p> <p>phase: double, carrier phase, unit: ° (degree).</p>
<b>RANGE</b>	<p>carrier_num: 1 ~ total number of carriers,</p> <p>segment: waveform segment in the ARB waveform segment list,</p> <p>freq_offset: -60 MHz ~ 60 MHz,</p> <p>power: -40 ~ 0,</p> <p>phase: -360 ~ 360.</p>
<b>RETURN</b>	<p>String</p> <p>Format: &lt;carrier&gt;,&lt;freq_offset&gt;,&lt;power&gt;,&lt;phase&gt;,&lt;sample_clock&gt;,&lt;sample_points&gt;</p>
<b>DEFAULT VALUE</b>	SINE_WAVE,0,0,0,2e+06,200\n
<b>EQUIVALENT MENU</b>	<b>IQ</b> > ARB > Multi Carrier > Carrier Table
<b>EXAMPLE</b>	<pre><i>:RADio:DMODulation:ARB:SETup:MCARrier:TABLE INIT,"RAMP_WAVE",1000000,-10,20  :RADio:DMODulation:ARB:SETup:MCARrier:TABLE APPend,"RAMP_WAVE",2000000,-5,90  :RADio:DMODulation:ARB:SETup:MCARrier:TABLE 2,"TEST",- 5000000,-2,-30  :RADio:DMODulation:ARB:SETup:MCARrier:TABLE? 1 Return: RAMP_WAVE,1e+06,-10,20,2e+06,200\n</i></pre>

#### 3.4.14.62 Multicarrier Save ([:SOURce]:RADio:DMODulation:ARB:SETup:MCARrier:STORE)

<b>SYNTAX</b>	[:SOURce]:RADio:DMODulation:ARB:SETup:MCARrier:STORE <"file_name">
<b>DESCRIPTION</b>	This command saves the multi carrier table to a ML file.
<b>DATA TYPE</b>	String
<b>RANGE</b>	Please refer to the user manual for naming rules.
<b>EQUIVALENT MENU</b>	<b>IQ</b> > ARB > Multi Carrier > Carrier Table > Save
<b>EXAMPLE</b>	<i>:RADio:DMODulation:ARB:SETup:MCARrier:STORE "Multi_Table.ml"</i>

**3.4.14.63 Multicarrier Load ([:SOURce]:IQ:CARRier:LOAD)**

<b>SYNTAX</b>	<code>[:SOURce]:IQ:CARRier:LOAD &lt;"file_name"&gt;</code>
<b>DESCRIPTION</b>	This command loads the multi carrier table from a ML file.
<b>DATA TYPE</b>	String
<b>RANGE</b>	None
<b>EQUIVALENT MENU</b>	<code>[IQ]</code> > ARB > Multi Carrier > Carrier Table > Load
<b>EXAMPLE</b>	<code>:IQ:CARRier:LOAD "Multi_Table.ml"</code>

**3.4.14.64 Multicarrier Power Reference ([:SOURce]:IQ:CARRier:POWER:TYPE)**

<b>SYNTAX</b>	<code>[:SOURce]:IQ:CARRier:POWER:TYPE RMS   PEAK</code> <code>[:SOURce]:IQ:CARRier:POWER:TYPE?</code>
<b>DESCRIPTION</b>	This command sets/queries the power reference type of ARB multi-carrier.
<b>DATA TYPE</b>	Enumeration
<b>RANGE</b>	RMS   PEAK
<b>RETURN</b>	Enumeration
<b>DEFAULT VALUE</b>	PEAK
<b>EQUIVALENT MENU</b>	<code>[IQ]</code> > ARB > Multi Carrier > Power Reference
<b>EXAMPLE</b>	<code>:IQ:CARRier:POWER:TYPE RMS</code> <code>:IQ:CARRier:POWER:TYPE?</code> Return: <code>RMS\n</code>

**3.4.14.65 Multicarrier Signal Period Mode ([:SOURce]:IQ:CARRier:PERIod:MODE)**

<b>SYNTAX</b>	<code>[:SOURce]:IQ:CARRier:PERIod:MODE LONGest   SHORtest   USER</code> <code>  LCM</code> <code>[:SOURce]:IQ:CARRier:PERIod:MODE?</code>
<b>DESCRIPTION</b>	This command sets/queries the signal period mode of ARB multi-carrier.
<b>DATA TYPE</b>	Enumeration
<b>RANGE</b>	LONGest   SHORtest   USER   LCM
<b>RETURN</b>	Enumeration
<b>DEFAULT VALUE</b>	LCM
<b>EQUIVALENT MENU</b>	<code>[IQ]</code> > ARB > Multi Carrier > Signal Period Mode
<b>EXAMPLE</b>	<code>:IQ:CARRier:PERIod:MODE LONGest</code> <code>:IQ:CARRier:PERIod:MODE?</code> Return: <code>LONGest\n</code>

**3.4.14.66 Multicarrier Signal Period ([:SOURce]:IQ:CARRier:PERIod)**

<b>SYNTAX</b>	<code>[:SOURce]:IQ:CARRier:PERIod &lt;value&gt;</code> <code>[:SOURce]:IQ:CARRier:PERIod?</code>
<b>DESCRIPTION</b>	When the multi-carrier signal period mode is custom, this command sets the multi-carrier signal period. The query command returns the signal period of the multi-carrier.
<b>DATA TYPE</b>	Float, unit: s
<b>RANGE</b>	200/multi-carrier sampling rate ~ min(10e6/multi-carrier sampling rate, (35e6 - total number of sub-carrier sampling points)/(3 * multi-carrier sampling rate))
<b>RETURN</b>	Float, unit: s
<b>DEFAULT VALUE</b>	None
<b>EQUIVALENT MENU</b>	<span style="border: 1px solid black; padding: 2px;">IQ</span> > ARB > Multi Carrier > Signal Period
<b>EXAMPLE</b>	<code>:IQ:CARRier:PERIod 10e-3</code> <code>:IQ:CARRier:PERIod?</code> Return: <code>0.01\n</code>

**3.4.14.67 Multicarrier Sampling Rate ([:SOURce]:IQ:CARRier:SAMPLerate?)**

<b>SYNTAX</b>	<code>[:SOURce]:IQ:CARRier:SAMPLerate?</code>
<b>DESCRIPTION</b>	This command queries the sampling rate of ARB multi-carrier.
<b>RETURN</b>	Float, unit: Hz
<b>DEFAULT VALUE</b>	None
<b>EQUIVALENT MENU</b>	<span style="border: 1px solid black; padding: 2px;">IQ</span> > ARB > Multi Carrier > Sampling Rate
<b>EXAMPLE</b>	<code>:IQ:CARRier:SAMPLerate?</code> Return: <code>21000000\n</code>

**3.4.15 I/Q Control****3.4.15.1 I/Q Mod State ([:SOURce]:DM:STATe)**

<b>SYNTAX</b>	<code>[:SOURce]:DM:STATe ON OFF 1 0</code> <code>[:SOURce]:DM:STATe?</code>
<b>DESCRIPTION</b>	This command sets/queries the switch status of the I/Q modulator.  <b>Note:</b> When the Custom modulation, ARB modulation, Stream modulation, IoT modulation, multi-tone or AWGN function is turned on, the I/Q modulator will be turned on automatically. You also need to turn on the IQ modulation master switch to enable the modulation function. For related commands, please refer to "IQ Modulation Switch ([:SOURce]:FUNCTION:DM:STATe)".
<b>DATA TYPE</b>	Boolean

<b>RANGE</b>	ON OFF 1 0
<b>RETURN</b>	1 0
<b>DEFAULT VALUE</b>	0
<b>EQUIVALENT MENU</b>	<b>IQ</b> > I/Q Control > I/Q Mod State
<b>EXAMPLE</b>	<i>:DM:STATe ON</i> <i>:DM:STATe?</i> Return: <i>1\n</i>

### 3.4.15.2 I/Q Source ([:SOURce]:DM:SOURce)

<b>SYNTAX</b>	[:SOURce]:DM:SOURce EXTernal INTernal [:SOURce]:DM:SOURce?
<b>DESCRIPTION</b>	This command selects/queries the I/Q modulator source.
<b>DATA TYPE</b>	Enumeration
<b>RANGE</b>	EXTernal INTernal
<b>RETURN</b>	Enumeration
<b>DEFAULT VALUE</b>	INTernal
<b>EQUIVALENT MENU</b>	<b>IQ</b> > I/Q Control > I/Q Source
<b>EXAMPLE</b>	<i>:DM:SOURce EXTernal</i> <i>:DM:SOURce?</i> Return: <i>EXTernal\n</i>

### 3.4.15.3 Compensation Channel ([:SOURce]:DM:BW:CAL:LINK)

<b>SYNTAX</b>	[:SOURce]:DM:BW:CAL:LINK RF OUTPut [:SOURce]:DM:BW:CAL:LINK?
<b>DESCRIPTION</b>	This command sets/queries broadband compensation links.
<b>DATA TYPE</b>	Enumeration
<b>RANGE</b>	RF OUTPut
<b>RETURN</b>	Enumeration
<b>DEFAULT VALUE</b>	RF
<b>EQUIVALENT MENU</b>	<b>IQ</b> > I/Q Control > Compensation Channel
<b>EXAMPLE</b>	<i>:DM:BW:CAL:LINK OUTPut</i> <i>:DM:BW:CAL:LINK?</i> Return: <i>OUTPut\n</i>

**3.4.15.4 I/Q Adjustment State ([:SOURce]:DM:IQADjustment[:STATe])**

<b>SYNTAX</b>	<code>[:SOURce]:DM:IQADjustment[:STATe] ON OFF 1 0</code> <code>[:SOURce]:DM:IQADjustment[:STATe]?</code>
<b>DESCRIPTION</b>	This command sets/queries the switch status of I/Q adjustment.
<b>DATA TYPE</b>	Boolean
<b>RANGE</b>	ON OFF 1 0
<b>RETURN</b>	1 0
<b>DEFAULT VALUE</b>	1
<b>EQUIVALENT MENU</b>	<b>IQ</b> > I/Q Control > I/Q Adjustment
<b>EXAMPLE</b>	<code>:DM:IQADjustment ON</code> <code>:DM:IQADjustment?</code> Return: 1\n

**3.4.15.5 Gain Balance ([:SOURce]:DM:IQADjustment:GAIN)**

<b>SYNTAX</b>	<code>[:SOURce]:DM:IQADjustment:GAIN &lt;val&gt;</code> <code>[:SOURce]:DM:IQADjustment:GAIN?</code>
<b>DESCRIPTION</b>	This command sets/queries the gain for the I signal relative to the Q signal.
<b>DATA TYPE</b>	Float, unit: dB
<b>RANGE</b>	-4 ~ 4
<b>RETURN</b>	Float, unit: dB
<b>DEFAULT VALUE</b>	0
<b>EQUIVALENT MENU</b>	<b>IQ</b> > I/Q Control > I/Q Adjustment > Gain Balance
<b>EXAMPLE</b>	<code>:DM:IQADjustment:GAIN -0.5</code> <code>:DM:IQADjustment:GAIN?</code> Return: -0.5\n

**3.4.15.6 I Offset ([:SOURce]:DM:IQADjustment:IOFFset)**

<b>SYNTAX</b>	<code>[:SOURce]:DM:IQADjustment:IOFFset &lt;val&gt;</code> <code>[:SOURce]:DM:IQADjustment:IOFFset?</code>
<b>DESCRIPTION</b>	This command adjusts the I channel offset value.
<b>DATA TYPE</b>	Float, unit: %
<b>RANGE</b>	-50 ~ 50
<b>RETURN</b>	Float, unit: %
<b>DEFAULT VALUE</b>	0
<b>EQUIVALENT MENU</b>	<b>IQ</b> > I/Q Control > I/Q Adjustment > I Offset
<b>EXAMPLE</b>	<code>:DM:IQADjustment:IOFFset 1.2</code>



---

```
:DM:IQADjustment:IOFFset?
```

```
Return:
```

```
1.2\n
```

---

### 3.4.15.7 Q Offset ([:SOURce]:DM:IQADjustment:QOFFset)

<b>SYNTAX</b>	<code>[:SOURce]:DM:IQADjustment:QOFFset &lt;val&gt;</code> <code>[:SOURce]:DM:IQADjustment:QOFFset?</code>
<b>DESCRIPTION</b>	This command adjusts the Q channel offset value.
<b>DATA TYPE</b>	Float, unit: %
<b>RANGE</b>	-50 ~ 50
<b>RETURN</b>	Float, unit: %
<b>DEFAULT VALUE</b>	0
<b>EQUIVALENT MENU</b>	<span style="border: 1px solid black; padding: 2px;">IQ</span> > I/Q Control > I/Q Adjustment > Q Offset
<b>EXAMPLE</b>	<pre><i>:DM:IQADjustment:QOFFset -0.35</i></pre> <pre><i>:DM:IQADjustment:QOFFset?</i></pre> Return: <pre><i>-0.35\n</i></pre>

### 3.4.15.8 Quad Angle Adjustment ([:SOURce]:DM:IQADjustment:QSKew)

<b>SYNTAX</b>	<code>[:SOURce]:DM:IQADjustment:QSKew &lt;val&gt;</code> <code>[:SOURce]:DM:IQADjustment:QSKew?</code>
<b>DESCRIPTION</b>	This command adjusts the phase angle (quadrature skew) between the I and Q vectors by increasing or decreasing the Q phase angle. It only affects the RF output path. Positive skew causes the angle to increase from 90 degrees, while negative skew causes the angle to decrease from 90 degrees. When the quadrature skew is zero, the phase angle between the I and Q vectors is 90 degrees.
<b>DATA TYPE</b>	Float, unit: degree
<b>RANGE</b>	-10 ~ 10
<b>RETURN</b>	Float, unit: degree
<b>DEFAULT VALUE</b>	0
<b>EQUIVALENT MENU</b>	<span style="border: 1px solid black; padding: 2px;">IQ</span> > I/Q Control > I/Q Adjustment > Quad Angle Adjustment
<b>EXAMPLE</b>	<pre><i>:DM:IQAD:QSK 1.52</i></pre> <pre><i>:DM:IQAD:QSK?</i></pre> Return: <pre><i>1.52\n</i></pre>

### 3.4.15.9 I/Q Output State ([:SOURce]:DM:IQADjustment:EXTernal[:STATe])

<b>SYNTAX</b>	<code>[:SOURce]:DM:IQADjustment:EXTernal[:STATe] ON OFF 1 0</code> <code>[:SOURce]:DM:IQADjustment:EXTernal[:STATe]?</code>
<b>DESCRIPTION</b>	This command sets/queries the output status of the I/Q signal.

<b>DATA TYPE</b>	Boolean
<b>RANGE</b>	ON OFF 1 0
<b>RETURN</b>	1 0
<b>DEFAULT VALUE</b>	0
<b>EQUIVALENT MENU</b>	<b>IQ</b> > I/Q Control > I/Q Output
<b>EXAMPLE</b>	<i>:DM:IQADjustment:EXternal 1</i> <i>:DM:IQADjustment:EXternal?</i> Return: <i>1</i>

#### 3.4.15.10 I/Q Output Atten ([:SOURce]:DM:IQADjustment:EXternal:IQATten)

<b>SYNTAX</b>	<i>[:SOURce]:DM:IQADjustment:EXternal:IQATten &lt;val&gt;</i> <i>[:SOURce]:DM:IQADjustment:EXternal:IQATten?</i>
<b>DESCRIPTION</b>	This command sets the attenuation value of the I/Q output.
<b>DATA TYPE</b>	Float, unit: dB
<b>RANGE</b>	0 ~ 20
<b>RETURN</b>	Float, unit: dB
<b>DEFAULT VALUE</b>	0
<b>EQUIVALENT MENU</b>	<b>IQ</b> > I/Q Control > I/Q Output > I/Q Output Atten
<b>EXAMPLE</b>	<i>:DM:IQADjustment:EXternal:IQATten 2.13</i> <i>:DM:IQADjustment:EXternal:IQATten?</i> Return: <i>2.13</i>

#### 3.4.15.11 I/Q Output Gain Balance ([:SOURce]:DM:IQADjustment:EXternal:GAIN)

<b>SYNTAX</b>	<i>[:SOURce]:DM:IQADjustment:EXternal:GAIN &lt;val&gt;</i> <i>[:SOURce]:DM:IQADjustment:EXternal:GAIN?</i>
<b>DESCRIPTION</b>	This command sets/queries the I/Q gain ratio for signals routed to the rear panel I and Q output connectors
<b>DATA TYPE</b>	Float, unit: dB
<b>RANGE</b>	-4 ~ 4
<b>RETURN</b>	Float, unit: dB
<b>DEFAULT VALUE</b>	0
<b>EQUIVALENT MENU</b>	<b>IQ</b> > I/Q Control > I/Q Output > I/Q Output Gain Balance
<b>EXAMPLE</b>	<i>:DM:IQADjustment:EXternal:GAIN -1.31</i> <i>:DM:IQADjustment:EXternal:GAIN?</i> Return: <i>-1.31</i>

**3.4.15.12 I Output Offset ([:SOURce]:DM:IQADjustment:EXTernal:DIOffset)**

<b>SYNTAX</b>	<code>[:SOURce]:DM:IQADjustment:EXTernal:DIOffset &lt;val&gt;</code> <code>[:SOURce]:DM:IQADjustment:EXTernal:DIOffset?</code>
<b>DESCRIPTION</b>	This command sets/queries the differential offset voltage for an in-phase (I) signal routed to the I output connectors.
<b>DATA TYPE</b>	Float, unit: mV or V, default is V
<b>RANGE</b>	-3 V ~ 3 V
<b>RETURN</b>	Float, unit: V
<b>DEFAULT VALUE</b>	0
<b>EQUIVALENT MENU</b>	<b>IQ</b> > I/Q Control > I/Q Output > I Output Offset
<b>EXAMPLE</b>	<code>:DM:IQADjustment:EXTernal:DIOffset 0.12</code> <code>:DM:IQADjustment:EXTernal:DIOffset?</code> Return: <code>0.12</code>

**3.4.15.13 Q Output Offset ([:SOURce]:DM:IQADjustment:DQOFFset)**

<b>SYNTAX</b>	<code>[:SOURce]:DM:IQADjustment:EXTernal:DQOFFset &lt;val&gt;</code> <code>[:SOURce]:DM:IQADjustment:EXTernal:DQOFFset?</code>
<b>DESCRIPTION</b>	This command sets/queries the differential offset voltage of the quadrature phase (Q) signal routed to the Q output connector.
<b>DATA TYPE</b>	Float, unit: mV or V, default is V
<b>RANGE</b>	-3 V ~ 3 V
<b>RETURN</b>	Float, unit: V
<b>DEFAULT VALUE</b>	0
<b>EQUIVALENT MENU</b>	<b>IQ</b> > I/Q Control > I/Q Output > Q Output Offset
<b>EXAMPLE</b>	<code>:DM:IQADjustment:EXTernal:DQOFFset -0.12</code> <code>:DM:IQADjustment:EXTernal:DQOFFset?</code> Return: <code>-0.12</code>

**3.4.15.14 I/Q Common Offset ([:SOURce]:DM:IQADjustment:EXTernal:COFFset)**

<b>SYNTAX</b>	<code>[:SOURce]:DM:IQADjustment:EXTernal:COFFset &lt;val&gt;</code> <code>[:SOURce]:DM:IQADjustment:EXTernal:COFFset?</code>
<b>DESCRIPTION</b>	This command sets/queries the common mode offset voltage for both the in-phase (I) and quadrature-phase(Q) signals going to the rear panel I and Q output connectors.
<b>DATA TYPE</b>	Float, unit: mV or V, default is V
<b>RANGE</b>	-3 V ~ 3 V
<b>RETURN</b>	Float, unit: V
<b>DEFAULT VALUE</b>	0

<b>EQUIVALENT MENU</b>	<code>[IQ]</code> > I/Q Control > I/Q Output > I/Q Common Offset
<b>EXAMPLE</b>	<code>:DM:IQADjustment:EXTernal:COFFset 1 mV</code> <code>:DM:IQADjustment:EXTernal:COFFset?</code> Return: 0.001\n

### 3.4.15.15 I/Q Swap ([:SOURce]:IQ:BW:SWAP)

<b>SYNTAX</b>	<code>[:SOURce]:IQ:BW:SWAP ON OFF 1 0</code> <code>[:SOURce]:IQ:BW:SWAP?</code>
<b>DESCRIPTION</b>	This command sets/queries the exchange status of I and Q signals. After enabling, the I signal remains unchanged, the Q signal will be inverted, and the spectrum is a mirror image of the normal mode.
<b>DATA TYPE</b>	Boolean
<b>RANGE</b>	ON OFF 1 0
<b>RETURN</b>	1 0
<b>DEFAULT VALUE</b>	0
<b>EQUIVALENT MENU</b>	<code>[IQ]</code> > I/Q Control > I/Q Swap
<b>EXAMPLE</b>	<code>:IQ:BW:SWAP ON</code> <code>:IQ:BW:SWAP?</code> Return: 1\n

## 3.4.16 IoT

### 3.4.16.1 Protocol Type ([:SOURce]:RADio:IOT:TYPE)

<b>SYNTAX</b>	<code>[:SOURce]:RADio:IOT:TYPE ZIGBee   ZWAVE</code> <code>[:SOURce]:RADio:IOT:TYPE?</code>
<b>DESCRIPTION</b>	This command sets/queries the protocol type of IoT modulation.
<b>DATA TYPE</b>	Enumeration
<b>RANGE</b>	ZIGBee   ZWAVE
<b>RETURN</b>	Enumeration
<b>DEFAULT VALUE</b>	ZIGBee
<b>EQUIVALENT MENU</b>	<code>[IQ]</code> > IoT > Protocol Type
<b>EXAMPLE</b>	<code>:RADio:IOT:TYPE ZWAVE</code> <code>:RADio:IOT:TYPE?</code> Return: ZWAVE\n

### 3.4.16.2 ZigBee

#### 3.4.16.2.1 Save Waveform ([:SOURce]:RADio:ZIGBee:SAVE)

<b>SYNTAX</b>	[:SOURce]:RADio:ZIGBee:SAVE <"file_name">
<b>DESCRIPTION</b>	This command saves ZigBee modulated waveform data to an ARB file.
<b>DATA TYPE</b>	String
<b>RANGE</b>	Please refer to the user manual for naming rules.
<b>EQUIVALENT MENU</b>	<span style="border: 1px solid black; padding: 2px;">IQ</span> > IoT > Protocol Type(ZigBee) > Save Waveform
<b>EXAMPLE</b>	<i>:RADio:ZIGBee:SAVE "test_zigbee.arb"</i>

#### 3.4.16.2.2 ZigBee State ([:SOURce]:RADio:ZIGBee:STATe)

<b>SYNTAX</b>	[:SOURce]:RADio:ZIGBee:STATe ON OFF 1 0 [:SOURce]:RADio:ZIGBee:STATe?
<b>DESCRIPTION</b>	This command sets/queries the switch status of ZigBee modulation.
<b>DATA TYPE</b>	Boolean
<b>RANGE</b>	ON OFF 1 0
<b>RETURN</b>	1 0
<b>DEFAULT VALUE</b>	0
<b>EQUIVALENT MENU</b>	<span style="border: 1px solid black; padding: 2px;">IQ</span> > IoT > Protocol Type(ZigBee) > ZigBee State
<b>EXAMPLE</b>	<i>:RADio:ZIGBee:STATe ON</i> <i>:RADio:ZIGBee:STATe?</i> Return: <i>1\n</i>

#### 3.4.16.2.3 OverSampling Ratio ([:SOURce]:RADio:ZIGBee:OSAMple:RATIo)

<b>SYNTAX</b>	[:SOURce]:RADio:ZIGBee:OSAMple:RATIo <val> [:SOURce]:RADio:ZIGBee:OSAMple:RATIo?
<b>DESCRIPTION</b>	This command sets/queries the oversampling rate of ZigBee modulated wave.
<b>DATA TYPE</b>	Integer
<b>RANGE</b>	2 ~ 64
<b>RETURN</b>	Integer
<b>DEFAULT VALUE</b>	8
<b>EQUIVALENT MENU</b>	<span style="border: 1px solid black; padding: 2px;">IQ</span> > IoT > Protocol Type(ZigBee) > Basic > OverSampling Ratio
<b>EXAMPLE</b>	<i>:RADio:ZIGBee:OSAMple:RATIo 10</i> <i>:RADio:ZIGBee:OSAMple:RATIo?</i> Return: <i>10\n</i>

**3.4.16.2.4 Number of Frames ([:SOURce]:RADio:ZIGBee:FRAMe:NUMBer)**

<b>SYNTAX</b>	<code>[:SOURce]:RADio:ZIGBee:FRAMe:NUMBer &lt;val&gt;</code> <code>[:SOURce]:RADio:ZIGBee:FRAMe:NUMBer?</code>
<b>DESCRIPTION</b>	This command sets and gets the number of frames contained in the ZigBee modulated wave.
<b>DATA TYPE</b>	Integer
<b>RANGE</b>	1 ~ 2000
<b>RETURN</b>	Integer
<b>DEFAULT VALUE</b>	1
<b>EQUIVALENT MENU</b>	<b>IQ</b> > IoT > Protocol Type(ZigBee) > Basic > Number of Frames
<b>EXAMPLE</b>	<code>:RADio:ZIGBee:FRAMe:NUMBer 2</code> <code>:RADio:ZIGBee:FRAMe:NUMBer?</code> Return: <code>2\n</code>

**3.4.16.2.5 Total Sample Points ([:SOURce]:RADio:ZIGBee:TOTAL:SAMPLe:POINts?)**

<b>SYNTAX</b>	<code>[:SOURce]:RADio:ZIGBee:TOTAL:SAMPLe:POINts?</code>
<b>DESCRIPTION</b>	This command queries the total number of sampling points of the ZigBee modulated wave.
<b>RETURN</b>	Integer
<b>DEFAULT VALUE</b>	None
<b>EQUIVALENT MENU</b>	<b>IQ</b> > IoT > Protocol Type(ZigBee) > Basic > Total Sample Points
<b>EXAMPLE</b>	<code>:RADio:ZIGBee:TOTAL:SAMPLe:POINts?</code> Return: <code>20608\n</code>

**3.4.16.2.6 Waveform Length ([:SOURce]:RADio:ZIGBee:WAVEform:LENGth?)**

<b>SYNTAX</b>	<code>[:SOURce]:RADio:ZIGBee:WAVEform:LENGth?</code>
<b>DESCRIPTION</b>	This command queries the waveform length of the ZigBee modulated wave.
<b>RETURN</b>	Float, unit: s
<b>DEFAULT VALUE</b>	None
<b>EQUIVALENT MENU</b>	<b>IQ</b> > IoT > Protocol Type(ZigBee) > Basic > Waveform Length
<b>EXAMPLE</b>	<code>:RADio:ZIGBee:WAVEform:LENGth?</code> Return: <code>0.00644\n</code>

**3.4.16.2.7 PHY SCHEme ([:SOURce]:RADio:ZIGBee:PHY:SCHEme)**

<b>SYNTAX</b>	<code>[:SOURce]:RADio:ZIGBee:PHY:SCHEme OQPSK BPSK</code> <code>[:SOURce]:RADio:ZIGBee:PHY:SCHEme?</code>
---------------	--

<b>DESCRIPTION</b>	This command sets/queries the modulation method of ZigBee modulation.
<b>DATA TYPE</b>	Enumeration
<b>RANGE</b>	OQPSK  BPSK
<b>RETURN</b>	Enumeration
<b>DEFAULT VALUE</b>	OQPSK
<b>EQUIVALENT MENU</b>	<input type="text" value="IQ"/> > IoT > Protocol Type(ZigBee) > General Settings > PHY SCHEme
<b>EXAMPLE</b>	<pre>:RADio:ZIGBee:PHY:SCHEme BPSK :RADio:ZIGBee:PHY:SCHEme? Return: BPSK\n</pre>

#### 3.4.16.2.8 Idle Interval ([:SOURce]:RADio:ZIGBee:IDLE)

<b>SYNTAX</b>	<pre>[:SOURce]:RADio:ZIGBee:IDLE &lt;val&gt; [:SOURce]:RADio:ZIGBee:IDLE?</pre>
<b>DESCRIPTION</b>	This command sets/queries the idle interval (in seconds) between frames contained in the ZigBee modulated wave.
<b>DATA TYPE</b>	Float, unit: ns, us, ms or s, default is s
<b>RANGE</b>	0 ~ 200 ms
<b>RETURN</b>	Float, unit: s
<b>DEFAULT VALUE</b>	100 us
<b>EQUIVALENT MENU</b>	<input type="text" value="IQ"/> > IoT > Protocol Type(ZigBee) > General Settings > Idle Interval
<b>EXAMPLE</b>	<pre>:RADio:ZIGBee:IDLE 10 ms :RADio:ZIGBee:IDLE? Return: 0.01\n</pre>

#### 3.4.16.2.9 Frequency Band ([:SOURce]:RADio:ZIGBee:FREQ:BAND)

<b>SYNTAX</b>	<pre>[:SOURce]:RADio:ZIGBee:FREQ:BAND F868M   F915M  F2450M [:SOURce]:RADio:ZIGBee:FREQ:BAND?</pre>
<b>DESCRIPTION</b>	This command sets/queries the frequency band of ZigBee modulation.
<b>DATA TYPE</b>	Enumeration
<b>RANGE</b>	F868M   F915M  F2450M
<b>RETURN</b>	Enumeration
<b>DEFAULT VALUE</b>	F868M
<b>EQUIVALENT MENU</b>	<input type="text" value="IQ"/> > IoT > Protocol Type(ZigBee) > General Settings > Frequency Band

---

**EXAMPLE**                    :*RADio:ZIGBee:FREQ:BAND F915M*  
                                   :*RADio:ZIGBee:FREQ:BAND?*  
 Return:  
*F915M\n*

---

#### 3.4.16.2.10 Data Rate ([:SOURce]:RADio:ZIGBee:RATE?)

---

<b>SYNTAX</b>	[:SOURce]:RADio:ZIGBee:RATE?
<b>DESCRIPTION</b>	This command queries the data rate of ZigBee modulated.
<b>RETURN</b>	Float, unit: b/s
<b>DEFAULT VALUE</b>	None
<b>EQUIVALENT MENU</b>	<input type="text" value="IQ"/> > IoT > Protocol Type(ZigBee) > General Settings > Data Rate

---

**EXAMPLE**                    :*RADio:ZIGBee:RATE?*  
 Return:  
*40000\n*

---

#### 3.4.16.2.11 Preamble ([:SOURce]:RADio:ZIGBee:PREAmble?)

---

<b>SYNTAX</b>	[:SOURce]:RADio:ZIGBee:PREAmble?
<b>DESCRIPTION</b>	This command gets the Preamble field (hexadecimal) of ZigBee PPDU.
<b>RETURN</b>	Integer
<b>DEFAULT VALUE</b>	00000000
<b>EQUIVALENT MENU</b>	<input type="text" value="IQ"/> > IoT > Protocol Type(ZigBee) > PPDU Settings > Preamble(Hex)

---

**EXAMPLE**                    :*RADio:ZIGBee:PREAmble?*  
 Return:  
*00000000\n*

---

#### 3.4.16.2.12 SFD ([:SOURce]:RADio:ZIGBee:SFD?)

---

<b>SYNTAX</b>	[:SOURce]:RADio:ZIGBee:SFD?
<b>DESCRIPTION</b>	This command gets the SFD field (hexadecimal) of ZigBee PPDU.
<b>RETURN</b>	Integer
<b>DEFAULT VALUE</b>	a7
<b>EQUIVALENT MENU</b>	<input type="text" value="IQ"/> > IoT > Protocol Type(ZigBee) > PPDU Settings > SFD(Hex)

---

**EXAMPLE**                    :*RADio:ZIGBee:SFD?*  
 Return:  
*a7\n*

---



**3.4.16.2.13 PHR ([:SOURCE]:RADIO:ZIGBEE:PHR?)**

<b>SYNTAX</b>	<code>[:SOURCE]:RADIO:ZIGBEE:PHR?</code>
<b>DESCRIPTION</b>	This command gets the PHR field (hexadecimal) of ZigBee PPDU.
<b>RETURN</b>	Integer
<b>DEFAULT VALUE</b>	21
<b>EQUIVALENT MENU</b>	<code>IQ</code> > IoT > Protocol Type(ZigBee) > PPDU Settings > PHR (Hex)
<b>EXAMPLE</b>	<code>:RADIO:ZIGBEE:PHR?</code> Return: <code>21\n</code>

**3.4.16.2.14 MAC Frame Type ([:SOURCE]:RADIO:ZIGBEE:FRAME:TYPE)**

<b>SYNTAX</b>	<code>[:SOURCE]:RADIO:ZIGBEE:FRAME:TYPE General   Beacon   Data   ACK   MAC</code> <code>[:SOURCE]:RADIO:ZIGBEE:FRAME:TYPE?</code>
<b>DESCRIPTION</b>	This command sets/queries the frame type of ZigBee modulation.
<b>DATA TYPE</b>	Enumeration
<b>RANGE</b>	General   Beacon   Data   ACK   MAC
<b>RETURN</b>	Enumeration
<b>DEFAULT VALUE</b>	General
<b>EQUIVALENT MENU</b>	<code>IQ</code> > IoT > Protocol Type(ZigBee) > PPDU Settings > MAC Frame Type
<b>EXAMPLE</b>	<code>:RADIO:ZIGBEE:FRAME:TYPE Data</code> <code>:RADIO:ZIGBEE:FRAME:TYPE?</code> Return: <code>Data\n</code>

**3.4.16.2.15 MAC Header State ([:SOURCE]:RADIO:ZIGBEE:MAC:HEADER:STATE)**

<b>SYNTAX</b>	<code>[:SOURCE]:RADIO:ZIGBEE:MAC:HEADER:STATE ON OFF 1 0</code> <code>[:SOURCE]:RADIO:ZIGBEE:MAC:HEADER:STATE?</code>
<b>DESCRIPTION</b>	This command sets/queries the enable status of the MAC Header field of ZigBee PPDU.
<b>DATA TYPE</b>	Boolean
<b>RANGE</b>	ON OFF 1 0
<b>RETURN</b>	1 0
<b>DEFAULT VALUE</b>	1
<b>EQUIVALENT MENU</b>	<code>IQ</code> > IoT > Protocol Type(ZigBee) > PPDU Settings > MAC Header
<b>EXAMPLE</b>	<code>:RADIO:ZIGBEE:MAC:HEADER:STATE OFF</code> <code>:RADIO:ZIGBEE:MAC:HEADER:STATE?</code> Return: <code>0\n</code>

**3.4.16.2.16 General MAC Frame Header ([:SOURce]:RADio:ZIGBee:FRAMe:GENERal)**

<b>SYNTAX</b>	<code>[:SOURce]:RADio:ZIGBee:FRAMe:GENERal &lt;"header"&gt;</code> <code>[:SOURce]:RADio:ZIGBee:FRAMe:GENERal?</code>
<b>DESCRIPTION</b>	This command sets/queries the MAC Header field of ZigBee General frame.
<b>DATA TYPE</b>	String
<b>RANGE</b>	None
<b>RETURN</b>	String
<b>DEFAULT VALUE</b>	8821,01,1234,5678,4321,8765,,, \n
<b>EQUIVALENT MENU</b>	<b>IQ</b> > IoT > Protocol Type(ZigBee) > PPDU Settings > MAC Frame Type(General) > MAC Header
<b>EXAMPLE</b>	<code>:RADio:ZIGBee:FRAMe:GENERal</code> <code>"8888,01,1234,5678,4321,8765,,,AABB"</code> <code>:RADio:ZIGBee:FRAMe:GENERal?</code> Return: <code>8888,01,1234,5678,4321,8765,,,AABB\n</code>

**3.4.16.2.17 Beacon Frame Header ([:SOURce]:RADio:ZIGBee:FRAMe:BEACon)**

<b>SYNTAX</b>	<code>[:SOURce]:RADio:ZIGBee:FRAMe:BEACon &lt;"header"&gt;</code> <code>[:SOURce]:RADio:ZIGBee:FRAMe:BEACon?</code>
<b>DESCRIPTION</b>	This command sets/queries the MAC Header field of ZigBee Beacon frame.
<b>DATA TYPE</b>	String
<b>RANGE</b>	None
<b>RETURN</b>	String
<b>DEFAULT VALUE</b>	8820,01,1234,5678,4321,8765,,0000,00,00\n
<b>EQUIVALENT MENU</b>	<b>IQ</b> > IoT > Protocol Type(ZigBee) > PPDU Settings > MAC Frame Type(Beacon) > MAC Header
<b>EXAMPLE</b>	<code>:RADio:ZIGBee:FRAMe:BEACon</code> <code>"8821,01,1234,5678,4321,8765,,0000,BD,00"</code> <code>:RADio:ZIGBee:FRAMe:BEACon?</code> Return: <code>8820,01,1234,5678,4321,8765,,0000,BD,00\n</code>

**3.4.16.2.18 Data Frame Header ([:SOURce]:RADio:ZIGBee:FRAMe:DATA)**

<b>SYNTAX</b>	<code>[:SOURce]:RADio:ZIGBee:FRAMe:DATA &lt;"header"&gt;</code> <code>[:SOURce]:RADio:ZIGBee:FRAMe:DATA?</code>
<b>DESCRIPTION</b>	This command sets/queries the MAC Header field of ZigBee Data frame.
<b>DATA TYPE</b>	String
<b>RANGE</b>	None

<b>RETURN</b>	String
<b>DEFAULT VALUE</b>	8821,01,1234,5678,4321,8765,,,\n
<b>EQUIVALENT MENU</b>	<b>IQ</b> > IoT > Protocol Type(ZigBee) > PPDU Settings > MAC Frame Type(Data) > MAC Header
<b>EXAMPLE</b>	<i>:RADio:ZIGBee:FRAME:DATA "8821,01,1234,5678,4321,8765,,AABB," :RADio:ZIGBee:FRAME:DATA? Return: 8821,01,1234,5678,4321,8765,,AABB,\n</i>

#### 3.4.16.2.19 Ack Frame Header ([:SOURce]:RADio:ZIGBee:FRAME:ACK)

<b>SYNTAX</b>	<code>[:SOURce]:RADio:ZIGBee:FRAME:ACK &lt;"header"&gt;</code> <code>[:SOURce]:RADio:ZIGBee:FRAME:ACK?</code>
<b>DESCRIPTION</b>	This command sets/queries the MAC Header field of ZigBee Ack frame.
<b>DATA TYPE</b>	String
<b>RANGE</b>	None
<b>RETURN</b>	String
<b>DEFAULT VALUE</b>	8822,01\n
<b>EQUIVALENT MENU</b>	<b>IQ</b> > IoT > Protocol Type(ZigBee) > PPDU Settings > MAC Frame Type(Ack) > MAC Header
<b>EXAMPLE</b>	<i>:RADio:ZIGBee:FRAME:ACK "1212,56" :RADio:ZIGBee:FRAME:ACK? Return: 1212,56\n</i>

#### 3.4.16.2.20 MAC Command Frame Header ([:SOURce]:RADio:ZIGBee:FRAME:MAC)

<b>SYNTAX</b>	<code>[:SOURce]:RADio:ZIGBee:FRAME:MAC &lt;"header"&gt;</code> <code>[:SOURce]:RADio:ZIGBee:FRAME:MAC?</code>
<b>DESCRIPTION</b>	This command sets/queries the MAC Header field of ZigBee MAC Command frame.
<b>DATA TYPE</b>	String
<b>RANGE</b>	None
<b>RETURN</b>	String
<b>DEFAULT VALUE</b>	8823,01,1234,5678,4321,8765,,,,,00\n
<b>EQUIVALENT MENU</b>	<b>IQ</b> > IoT > Protocol Type(ZigBee) > PPDU Settings > MAC Frame Type(MAC Command) > MAC Header
<b>EXAMPLE</b>	<i>:RADio:ZIGBee:FRAME:MAC "8823,56,1234,5678,4321,8765,, AABB,,12" :RADio:ZIGBee:FRAME:MAC? Return: 8823,01,1234,5678,4321,8765,,,,,00\n</i>

**3.4.16.2.21 Data Type ([:SOURce]:RADio:ZIGBee:PNTYpe)**

<b>SYNTAX</b>	<code>[:SOURce]:RADio:ZIGBee:PNTYpe PN9   PN15   USER</code> <code>[:SOURce]:RADio:ZIGBee:PNTYpe?</code>
<b>DESCRIPTION</b>	This command sets/queries the data type of ZigBee PPDU.
<b>DATA TYPE</b>	Enumeration
<b>RANGE</b>	PN9   PN15   USER
<b>RETURN</b>	Enumeration
<b>DEFAULT VALUE</b>	PN9
<b>EQUIVALENT MENU</b>	<b>IQ</b> > IoT > Protocol Type(ZigBee) > PPDU Settings > Data Type
<b>EXAMPLE</b>	<code>:RADio:ZIGBee:PNTYpe PN15</code> <code>:RADio:ZIGBee:PNTYpe?</code> Return: <code>PN15</code>

**3.4.16.2.22 Seed ([:SOURce]:RADio:ZIGBee:SEED)**

<b>SYNTAX</b>	<code>[:SOURce]:RADio:ZIGBee:SEED &lt;val&gt;</code> <code>[:SOURce]:RADio:ZIGBee:SEED?</code>
<b>DESCRIPTION</b>	This command sets the seed that generates the PN sequence.
<b>DATA TYPE</b>	Integer
<b>RANGE</b>	1 ~ 32767
<b>RETURN</b>	Integer
<b>DEFAULT VALUE</b>	511
<b>EQUIVALENT MENU</b>	<b>IQ</b> > IoT > Protocol Type(ZigBee) > PPDU Settings > Seed(Hex)
<b>EXAMPLE</b>	<code>:RADio:ZIGBee:SEED 974</code> <code>:RADio:ZIGBee:SEED?</code> Return: <code>974</code>

**3.4.16.2.23 Custom PN Data ([:SOURce]:RADio:ZIGBee:PN:USER:DATA)**

<b>SYNTAX</b>	<code>[:SOURce]:RADio:ZIGBee:PN:USER:DATA &lt;user_data&gt;</code>
<b>DESCRIPTION</b>	This command sets custom PN data for the ZigBee PPDU Payload field.
<b>DATA TYPE</b>	Binary string
<b>RANGE</b>	None
<b>EQUIVALENT MENU</b>	<b>IQ</b> > IoT > Protocol Type(ZigBee) > PPDU Settings > Data Type (User) > User Data
<b>EXAMPLE</b>	<code>:RADio:ZIGBee:PN:USER:DATA 010100110011</code>

**3.4.16.2.24 Get PN Data ([:SOURce]:RADio:ZIGBee:PN:DATA?)**

<b>SYNTAX</b>	<code>[:SOURce]:RADio:ZIGBee:PN:DATA? PN9   PN15   USER</code>
<b>DESCRIPTION</b>	This command queries the PN data of the ZigBee PPDU Payload field.
<b>DATA TYPE</b>	Enumeration
<b>RANGE</b>	PN9   PN15   USER
<b>RETURN</b>	Binary string
<b>DEFAULT VALUE</b>	None
<b>EQUIVALENT MENU</b>	IQ > IoT > Protocol Type(ZigBee) > PPDU Settings > Data Type (User) > User Data
<b>EXAMPLE</b>	<code>:RADio:ZIGBee:PN:DATA? USER</code> Return: <code>0101001100111n</code>

**3.4.16.2.25 Store User PN Data ([:SOURce]:RADio:ZIGBee:PN:SAVE)**

<b>SYNTAX</b>	<code>[:SOURce]:RADio:ZIGBee:PN:SAVE &lt;"file_name"&gt;</code>
<b>DESCRIPTION</b>	This command saves the customized PN data of the ZigBee PPDU Payload field into the UDATA file.
<b>DATA TYPE</b>	String
<b>RANGE</b>	Please refer to the user manual for naming rules.
<b>EQUIVALENT MENU</b>	<code>IQ</code> > IoT > Protocol Type(ZigBee) > PPDU Settings > Data Type (User) > User Data > Save
<b>EXAMPLE</b>	<code>:RADio:ZIGBee:PN:SAVE "test.udata"</code>

**3.4.16.2.26 Load User PN Data ([:SOURce]:RADio:ZIGBee:PN:LOAD)**

<b>SYNTAX</b>	<code>[:SOURce]:RADio:ZIGBee:PN:LOAD &lt;"file_name"&gt;</code>
<b>DESCRIPTION</b>	This command loads the custom PN data of the ZigBee PPDU Payload field from the UDATA file.
<b>DATA TYPE</b>	String
<b>RANGE</b>	None
<b>EQUIVALENT MENU</b>	<code>IQ</code> > IoT > Protocol Type(ZigBee) > PPDU Settings > Data Type (User) > User Data > Load
<b>EXAMPLE</b>	<code>:RADio:ZIGBee:PN:LOAD "test.udata"</code>

**3.4.16.2.27 Data Length ([:SOURce]:RADio:ZIGBee:FRAME:LEN)**

<b>SYNTAX</b>	<code>[:SOURce]:RADio:ZIGBee:FRAME:LEN &lt;val&gt;</code> <code>[:SOURce]:RADio:ZIGBee:FRAME:LEN?</code>
<b>DESCRIPTION</b>	This command sets/queries the data length of the ZigBee PPDU

	Payload field.
<b>DATA TYPE</b>	Integer, unit: octets
<b>RANGE</b>	0 ~ 114
<b>RETURN</b>	Integer, unit: octets
<b>DEFAULT VALUE</b>	20
<b>EQUIVALENT MENU</b>	<b>IQ</b> > IoT > Protocol Type(ZigBee) > PPDU Settings > Data Length
<b>EXAMPLE</b>	<i>:RADio:ZIGBee:FRAMe:LEN 10</i> <i>:RADio:ZIGBee:FRAMe:LEN?</i> Return: <i>10\n</i>

#### 3.4.16.2.28 Data Mode ([:SOURce]:RADio:ZIGBee:CONTInuous:STATe)

<b>SYNTAX</b>	<i>[:SOURce]:RADio:ZIGBee:CONTInuous:STATe ON OFF 1 0</i> <i>[:SOURce]:RADio:ZIGBee:CONTInuous:STATe?</i>
<b>DESCRIPTION</b>	This command enables or disables data continuity status. Continuous mode will have the data bits spread out continuously over multiple frames, truncated mode will have the same payload data bits for all frames.
<b>DATA TYPE</b>	Boolean
<b>RANGE</b>	ON OFF 1 0
<b>RETURN</b>	1 0
<b>DEFAULT VALUE</b>	0
<b>EQUIVALENT MENU</b>	<b>IQ</b> > IoT > Protocol Type(ZigBee) > PPDU Settings > Data Mode
<b>EXAMPLE</b>	<i>:RADio:ZIGBee:CONTInuous:STATe 1</i> <i>:RADio:ZIGBee:CONTInuous:STATe?</i> Return: <i>1\n</i>

#### 3.4.16.2.29 MAC FCS State ([:SOURce]:RADio:ZIGBee:FCS:STATe)

<b>SYNTAX</b>	<i>[:SOURce]:RADio:ZIGBee:FCS:STATe ON OFF 1 0</i> <i>[:SOURce]:RADio:ZIGBee:FCS:STATe?</i>
<b>DESCRIPTION</b>	This command enables or disables MAC FCS in the PSDU. When turned off, it can be used to simulate an invalid FCS condition since the FCS section is actually filled with user data bits.
<b>DATA TYPE</b>	Boolean
<b>RANGE</b>	ON OFF 1 0
<b>RETURN</b>	1 0
<b>DEFAULT VALUE</b>	1
<b>EQUIVALENT MENU</b>	<b>IQ</b> > IoT > Protocol Type(ZigBee) > PPDU Settings > MAC FCS

---

**EXAMPLE**                    *:RADio:ZIGBee:FCS:STATe 0*  
                                   *:RADio:ZIGBee:FCS:STATe?*  
 Return:  
*0\n*

---

#### 3.4.16.2.30 Symbol Timing Error ([:SOURce]:RADio:ZIGBee:SYMBle:TIMIng:ERROr)

---

<b>SYNTAX</b>	<i>[:SOURce]:RADio:ZIGBee:SYMBle:TIMIng:ERROr &lt;val&gt;</i> <i>[:SOURce]:RADio:ZIGBee:SYMBle:TIMIng:ERROr?</i>
<b>DESCRIPTION</b>	This command sets the shift to the standard symbol rate in ppm.
<b>DATA TYPE</b>	Integer, unit: ppm
<b>RANGE</b>	-300 ~ 300
<b>RETURN</b>	Integer, unit: ppm
<b>DEFAULT VALUE</b>	0
<b>EQUIVALENT MENU</b>	<span style="border: 1px solid black; padding: 2px;">IQ</span> > IoT > Protocol Type(ZigBee) > Impairments > Symbol Timing Error

---

**EXAMPLE**                    *:RADio:ZIGBee:SYMBle:TIMIng:ERROr -10*  
                                   *:RADio:ZIGBee:SYMBle:TIMIng:ERROr?*  
 Return:  
*-10\n*

---

#### 3.4.16.2.31 Frequency Offset ([:SOURce]:RADio:ZIGBee:FREQ:OFFSET)

---

<b>SYNTAX</b>	<i>[:SOURce]:RADio:ZIGBee:FREQ:OFFSET &lt;val&gt;</i> <i>[:SOURce]:RADio:ZIGBee:FREQ:OFFSET?</i>
<b>DESCRIPTION</b>	This command sets or gets the offset (in Hz) of the nominal carrier frequency for ZigBee modulation.
<b>DATA TYPE</b>	Float, unit: Hz
<b>RANGE</b>	-200000 ~ 200000
<b>RETURN</b>	Float, unit: Hz
<b>DEFAULT VALUE</b>	0
<b>EQUIVALENT MENU</b>	<span style="border: 1px solid black; padding: 2px;">IQ</span> > IoT > Protocol Type(ZigBee) > Impairments > Frequency Offset

---

**EXAMPLE**                    *:RADio:ZIGBee:FREQ:OFFSET 1000*  
                                   *:RADio:ZIGBee:FREQ:OFFSET?*  
 Return:  
*1000\n*

---

#### 3.4.16.2.32 Marker 1 Source ([:SOURce]:RADio:ZIGBee:MARKer:ONE:SOURce)

---

<b>SYNTAX</b>	<i>[:SOURce]:RADio:ZIGBee:MARKer:ONE:SOURce WAVEform FRAME</i> <i>[:SOURce]:RADio:ZIGBee:MARKer:ONE:SOURce?</i>
<b>DESCRIPTION</b>	This command sets/queries the source of Mark 1 of the ZigBee

---

	modulated wave. Waveform Start - Indicates the start of the waveform, Frame Start - Indicates the beginning of each frame in the waveform.
<b>DATA TYPE</b>	Enumeration
<b>RANGE</b>	WAVEform  FRAME
<b>RETURN</b>	Enumeration
<b>DEFAULT VALUE</b>	FRAME
<b>EQUIVALENT MENU</b>	<code>[IQ]</code> > IoT > Protocol Type(ZigBee) > Marker > Marker 1 Source
<b>EXAMPLE</b>	<code>:RADio:ZIGBee:MARKer:ONE:SOURce WAVEform</code> <code>:RADio:ZIGBee:MARKer:ONE:SOURce?</code> Return: <code>WAVEform\n</code>

#### 3.4.16.2.33 Marker 2 Source ([:SOURce]:RADio:ZIGBee:MARKer:TWO:SOURce)

<b>SYNTAX</b>	<code>[:SOURce]:RADio:ZIGBee:MARKer:TWO:SOURce WAVEform </code> <code>FRAME</code> <code>[:SOURce]:RADio:ZIGBee:MARKer:TWO:SOURce?</code>
<b>DESCRIPTION</b>	This command sets/queries the source of Mark 2 of the ZigBee modulated wave. Waveform Start - Indicates the start of the waveform, Frame Start - Indicates the beginning of each frame in the waveform.
<b>DATA TYPE</b>	Enumeration
<b>RANGE</b>	WAVEform  FRAME
<b>RETURN</b>	Enumeration
<b>DEFAULT VALUE</b>	FRAME
<b>EQUIVALENT MENU</b>	<code>[IQ]</code> > IoT > Protocol Type(ZigBee) > Marker > Marker 2 Source
<b>EXAMPLE</b>	<code>:RADio:ZIGBee:MARKer:TWO:SOURce WAVEform</code> <code>:RADio:ZIGBee:MARKer:TWO:SOURce?</code> Return: <code>WAVEform\n</code>

#### 3.4.16.2.34 ZigBee Trigger Type ([:SOURce]:RADio:ZIGBee:TRIGger:TYPE)

<b>SYNTAX</b>	<code>[:SOURce]:RADio:ZIGBee:TRIGger:TYPE CONTInous  SINGle </code> <code>GATE</code> <code>[:SOURce]:RADio:ZIGBee:TRIGger:TYPE?</code>
<b>DESCRIPTION</b>	This command sets/queries the trigger type of ZigBee.
<b>DATA TYPE</b>	Enumeration
<b>RANGE</b>	CONTInous  SINGle  GATE
<b>RETURN</b>	Enumeration
<b>DEFAULT VALUE</b>	CONTInous



<b>EQUIVALENT MENU</b>	<code>[IQ] &gt; IoT &gt; Protocol Type(ZigBee) &gt; Trigger &gt; Trigger Type</code>
<b>EXAMPLE</b>	<code>:RADio:ZIGBee:TRIGger:TYPE SINGle</code> <code>:RADio:ZIGBee:TRIGger:TYPE?</code> Return: <code>SINGle\n</code>

#### 3.4.16.2.35 ZigBee Trigger Continuous Mode ([:SOURce]:RADio:ZIGBee:TRIGger:CONTInous)

<b>SYNTAX</b>	<code>[:SOURce]:RADio:ZIGBee:TRIGger:CONTInous FREErun   RUNIgnored</code> <code>[:SOURce]:RADio:ZIGBee:TRIGger:CONTInous?</code>
<b>DESCRIPTION</b>	This command sets/queries the trigger mode of ZigBee continuous trigger.
<b>DATA TYPE</b>	Enumeration
<b>RANGE</b>	FREErun   RUNIgnored
<b>RETURN</b>	Enumeration
<b>DEFAULT VALUE</b>	FREErun
<b>EQUIVALENT MENU</b>	<code>[IQ] &gt; IoT &gt; Protocol Type(ZigBee) &gt; Trigger &gt; Trigger Type(Continuous) &gt; Continuous Mode</code>
<b>EXAMPLE</b>	<code>:RADio:ZIGBee:TRIGger:CONTInous RUNIgnored</code> <code>:RADio:ZIGBee:TRIGger:CONTInous?</code> Return: <code>RUNIgnored\n</code>

#### 3.4.16.2.36 ZigBee Trigger Gate Mode ([:SOURce]:RADio:ZIGBee:TRIGger:GATE)

<b>SYNTAX</b>	<code>[:SOURce]:RADio:ZIGBee:TRIGger:GATE LOW   HIGH</code> <code>[:SOURce]:RADio:ZIGBee:TRIGger:GATE?</code>
<b>DESCRIPTION</b>	This command sets/queries the trigger mode of ZigBee external gating trigger.
<b>DATA TYPE</b>	Enumeration
<b>RANGE</b>	LOW   HIGH
<b>RETURN</b>	Enumeration
<b>DEFAULT VALUE</b>	LOW
<b>EQUIVALENT MENU</b>	<code>[IQ] &gt; IoT &gt; Protocol Type(ZigBee) &gt; Trigger &gt; Trigger Type(Ext Gated) &gt; Gate Mode</code>
<b>EXAMPLE</b>	<code>:RADio:ZIGBee:TRIGger:GATE HIGH</code> <code>:RADio:ZIGBee:TRIGger:GATE?</code> Return: <code>HIGH\n</code>

**3.4.16.2.37 ZigBee Trigger Source ([:SOURce]:RADio:ZIGBee:TRIGger:SOURce)**

<b>SYNTAX</b>	<code>[:SOURce]:RADio:ZIGBee:TRIGger:SOURce KEY  BUS  EXT</code> <code>[:SOURce]:RADio:ZIGBee:TRIGger:SOURce?</code>
<b>DESCRIPTION</b>	This command sets/queries the trigger source of ZigBee trigger.
<b>DATA TYPE</b>	Enumeration
<b>RANGE</b>	KEY  BUS  EXT
<b>RETURN</b>	Enumeration
<b>DEFAULT VALUE</b>	KEY
<b>EQUIVALENT MENU</b>	<b>IQ</b> > IoT > Protocol Type(ZigBee) > Trigger > Trigger Source
<b>EXAMPLE</b>	<code>:RADio:ZIGBee:TRIGger:SOURce BUS</code> <code>:RADio:ZIGBee:TRIGger:SOURce?</code> Return: <code>BUS\n</code>

**3.4.16.2.38 ZigBee Trigger Polarity ([:SOURce]:RADio:ZIGBee:TRIGger:POL)**

<b>SYNTAX</b>	<code>[:SOURce]:RADio:ZIGBee:TRIGger:POL POS   NEG</code> <code>[:SOURce]:RADio:ZIGBee:TRIGger:POL?</code>
<b>DESCRIPTION</b>	This command sets/queries the trigger polarity of ZigBee external trigger.
<b>DATA TYPE</b>	Enumeration
<b>RANGE</b>	POS   NEG
<b>RETURN</b>	Enumeration
<b>DEFAULT VALUE</b>	POS
<b>EQUIVALENT MENU</b>	<b>IQ</b> > IoT > Protocol Type(ZigBee) > Trigger > Trigger Source(Ext) > Ext Polarity
<b>EXAMPLE</b>	<code>:RADio:ZIGBee:TRIGger:POL NEG</code> <code>:RADio:ZIGBee:TRIGger:POL?</code> Return: <code>NEG\n</code>

**3.4.16.2.39 ZigBee Trigger Delay Samples ([:SOURce]:RADio:ZIGBee:TRIGger:DELAy:SAMPlE)**

<b>SYNTAX</b>	<code>[:SOURce]:RADio:ZIGBee:TRIGger:DELAy:SAMPlE &lt;samples&gt;</code> <code>[:SOURce]:RADio:ZIGBee:TRIGger:DELAy:SAMPlE?</code>
<b>DESCRIPTION</b>	This command sets/queries the trigger delay samples of ZigBee external trigger.
<b>DATA TYPE</b>	Integer
<b>RANGE</b>	0 ~ 100000000
<b>RETURN</b>	Integer
<b>DEFAULT VALUE</b>	0

<b>EQUIVALENT MENU</b>	<code>[IQ] &gt; IoT &gt; Protocol Type(ZigBee) &gt; Trigger &gt; Trigger Source(Ext) &gt; Delay Samples</code>
<b>EXAMPLE</b>	<code>:RADio:ZIGBee:TRIGger:DELAy:SAMPlE 1000</code> <code>:RADio:ZIGBee:TRIGger:DELAy:SAMPlE?</code> Return: <code>1000\n</code>

#### 3.4.16.2.40 ZigBee Bus Trigger ([:SOURce]:RADio:ZIGBee:TRG)

<b>SYNTAX</b>	<code>[:SOURce]:RADio:ZIGBee:TRG</code>
<b>DESCRIPTION</b>	This command sends a trigger signal of the ZigBee bus trigger source.
<b>EQUIVALENT MENU</b>	None
<b>EXAMPLE</b>	<code>:RADio:ZIGBee:TRG</code>

### 3.4.16.3 Z-Wave

#### 3.4.16.3.1 Save Waveform ([:SOURce]:RADio:ZWAVE:SAVE)

<b>SYNTAX</b>	<code>[:SOURce]:RADio:ZWAVE:SAVE &lt;"file_name"&gt;</code>
<b>DESCRIPTION</b>	This command saves Z-Wave modulated waveform data to an ARB file.
<b>DATA TYPE</b>	String
<b>RANGE</b>	Please refer to the user manual for naming rules.
<b>EQUIVALENT MENU</b>	<code>[IQ] &gt; IoT &gt; Protocol Type(Z-Wave) &gt; Save Waveform</code>
<b>EXAMPLE</b>	<code>:RADio:ZWAVE:SAVE "test_zwave.arb"</code>

#### 3.4.16.3.2 Z-Wave State ([:SOURce]:RADio:ZWAVE:STATe)

<b>SYNTAX</b>	<code>[:SOURce]:RADio:ZWAVE:STATe ON OFF 1 0</code> <code>[:SOURce]:RADio:ZWAVE:STATe?</code>
<b>DESCRIPTION</b>	This command sets/queries the switch status of Z-Wave modulation.
<b>DATA TYPE</b>	Boolean
<b>RANGE</b>	ON OFF 1 0
<b>RETURN</b>	1 0
<b>DEFAULT VALUE</b>	0
<b>EQUIVALENT MENU</b>	<code>[IQ] &gt; IoT &gt; Protocol Type(Z-Wave) &gt; Z-Wave State</code>
<b>EXAMPLE</b>	<code>:RADio:ZWAVE:STATe ON</code> <code>:RADio:ZWAVE:STATe?</code> Return: <code>1\n</code>

**3.4.16.3.3 OverSampling Ratio ([:SOURce]:RADio:ZWAVE:OSAMple:RATIo)**

<b>SYNTAX</b>	<code>[:SOURce]:RADio:ZWAVE:OSAMple:RATIo &lt;val&gt;</code> <code>[:SOURce]:RADio:ZWAVE:OSAMple:RATIo?</code>
<b>DESCRIPTION</b>	This command sets/queries the oversampling rate of Z-Wave modulated wave.
<b>DATA TYPE</b>	Integer
<b>RANGE</b>	2 ~ 64
<b>RETURN</b>	Integer
<b>DEFAULT VALUE</b>	8
<b>EQUIVALENT MENU</b>	<span style="border: 1px solid black; padding: 2px;">IQ</span> > IoT > Protocol Type(Z-Wave) > Basic > OverSampling Ratio
<b>EXAMPLE</b>	<code>:RADio:ZWAVE:OSAMple:RATIo 10</code> <code>:RADio:ZWAVE:OSAMple:RATIo?</code> Return: <code>10</code>

**3.4.16.3.4 Number of Frames ([:SOURce]:RADio:ZWAVE:FRAME:NUMBER)**

<b>SYNTAX</b>	<code>[:SOURce]:RADio:ZWAVE:FRAME:NUMBER &lt;val&gt;</code> <code>[:SOURce]:RADio:ZWAVE:FRAME:NUMBER?</code>
<b>DESCRIPTION</b>	This command sets and gets the number of frames contained in the Z-Wave modulated wave.
<b>DATA TYPE</b>	Integer
<b>RANGE</b>	1 ~ 2000
<b>RETURN</b>	Integer
<b>DEFAULT VALUE</b>	1
<b>EQUIVALENT MENU</b>	<span style="border: 1px solid black; padding: 2px;">IQ</span> > IoT > Protocol Type(Z-Wave) > Basic > Number of Frames
<b>EXAMPLE</b>	<code>:RADio:ZWAVE:FRAME:NUMBER 2</code> <code>:RADio:ZWAVE:FRAME:NUMBER?</code> Return: <code>2</code>

**3.4.16.3.5 Total Sample Points ([:SOURce]:RADio:ZWAVE:TOTAL:SAMple:POINts?)**

<b>SYNTAX</b>	<code>[:SOURce]:RADio:ZWAVE:TOTAL:SAMple:POINts?</code>
<b>DESCRIPTION</b>	This command queries the total number of sampling points of the Z-Wave modulated wave.
<b>RETURN</b>	Integer
<b>DEFAULT VALUE</b>	None
<b>EQUIVALENT MENU</b>	<span style="border: 1px solid black; padding: 2px;">IQ</span> > IoT > Protocol Type(Z-Wave) > Basic > Total Sample Points
<b>EXAMPLE</b>	<code>:RADio:ZWAVE:TOTAL:SAMple:POINts?</code> Return: <code>17720</code>

**3.4.16.3.6 Waveform Length ([:SOURce]:RADio:ZWAVE:WAVEform:LENGth?)**

<b>SYNTAX</b>	<code>[:SOURce]:RADio:ZWAVE:WAVEform:LENGth?</code>
<b>DESCRIPTION</b>	This command queries the waveform length of the Z-Wave modulated wave.
<b>RETURN</b>	Float, unit: s
<b>DEFAULT VALUE</b>	None
<b>EQUIVALENT MENU</b>	<code>IQ</code> > IoT > Protocol Type(Z-Wave) > Basic > Waveform Length
<b>EXAMPLE</b>	<code>:RADio:ZWAVE:WAVEform:LENGth?</code> Return: <code>0.0922916666666667\n</code>

**3.4.16.3.7 Data Rate ([:SOURce]:RADio:ZWAVE:RATE:TYPE)**

<b>SYNTAX</b>	<code>[:SOURce]:RADio:ZWAVE:RATE:TYPE R1 R2 R3</code> <code>[:SOURce]:RADio:ZWAVE:RATE:TYPE?</code>
<b>DESCRIPTION</b>	This command sets/queries the data rate of Z-Wave modulation.
<b>DATA TYPE</b>	Enumeration
<b>RANGE</b>	R1 R2 R3
<b>RETURN</b>	Enumeration
<b>DEFAULT VALUE</b>	R1
<b>EQUIVALENT MENU</b>	<code>IQ</code> > IoT > Protocol Type(Z-Wave) > General Settings > Data Rate
<b>EXAMPLE</b>	<code>:RADio:ZWAVE:RATE:TYPE R2</code> <code>:RADio:ZWAVE:RATE:TYPE?</code> Return: <code>R2\n</code>

**3.4.16.3.8 Modulation Type ([:SOURce]:RADio:ZWAVE:MODUlation:TYPE)**

<b>SYNTAX</b>	<code>[:SOURce]:RADio:ZWAVE:MODUlation:TYPE FSK   GFSK</code> <code>[:SOURce]:RADio:ZWAVE:MODUlation:TYPE?</code>
<b>DESCRIPTION</b>	This command sets/queries the modulation type of Z-Wave modulation.
<b>DATA TYPE</b>	Enumeration
<b>RANGE</b>	FSK   GFSK
<b>RETURN</b>	Enumeration
<b>DEFAULT VALUE</b>	R1/R2 is FSK and R3 is GFSK.
<b>EQUIVALENT MENU</b>	<code>IQ</code> > IoT > Protocol Type(Z-Wave) > General Settings > Modulation
<b>EXAMPLE</b>	<code>:RADio:ZWAVE:MODUlation:TYPE GFSK</code> <code>:RADio:ZWAVE:MODUlation:TYPE?</code> Return: <code>GFSK\n</code>

**3.4.16.3.9 Idle Interval ([:SOURce]:RADio:ZWAVE:IDLE)**

<b>SYNTAX</b>	<code>[:SOURce]:RADio:ZWAVE:IDLE &lt;val&gt;</code> <code>[:SOURce]:RADio:ZWAVE:IDLE?</code>
<b>DESCRIPTION</b>	This command sets/queries the idle interval (in seconds) between frames contained in the Z-Wave modulated wave.
<b>DATA TYPE</b>	Float, unit: ns, us, ms or s, default is s
<b>RANGE</b>	0 ~ 200 ms
<b>RETURN</b>	Float, unit: s
<b>DEFAULT VALUE</b>	100 us
<b>EQUIVALENT MENU</b>	<b>IQ</b> > IoT > Protocol Type(Z-Wave) > General Settings > Idle Interval
<b>EXAMPLE</b>	<code>:RADio:ZWAVE:IDLE 10 ms</code> <code>:RADio:ZWAVE:IDLE?</code> Return: <code>0.01</code>

**3.4.16.3.10 Ramp Symbols ([:SOURce]:RADio:ZWAVE:RAMP:SYMBOL)**

<b>SYNTAX</b>	<code>[:SOURce]:RADio:ZWAVE:RAMP:SYMBOL &lt;val&gt;</code> <code>[:SOURce]:RADio:ZWAVE:RAMP:SYMBOL?</code>
<b>DESCRIPTION</b>	This command sets/queries the number of sustained symbols for the rising and falling slopes of the Z-Wave modulated waveform.
<b>DATA TYPE</b>	Integer
<b>RANGE</b>	1 ~ 10
<b>RETURN</b>	Integer
<b>DEFAULT VALUE</b>	10
<b>EQUIVALENT MENU</b>	<b>IQ</b> > IoT > Protocol Type(Z-Wave) > Basic > Ramp Symbols
<b>EXAMPLE</b>	<code>:RADio:ZWAVE:RAMP:SYMBOL 6</code> <code>:RADio:ZWAVE:RAMP:SYMBOL?</code> Return: <code>6</code>

**3.4.16.3.11 Ramp Up/Down Symbol ([:SOURce]:RADio:ZWAVE:RAMP:MODE)**

<b>SYNTAX</b>	<code>[:SOURce]:RADio:ZWAVE:RAMP:MODE</code> <code>FIRLast CENTer ONE ZERO</code> <code>[:SOURce]:RADio:ZWAVE:RAMP:MODE?</code>
<b>DESCRIPTION</b>	This command selects/queries the symbol type of the rising and falling periods of the Z-Wave modulated waveform ramp.
<b>DATA TYPE</b>	Enumeration
<b>RANGE</b>	<code>FIRLast CENTer ONE ZERO</code>
<b>RETURN</b>	Enumeration

<b>DEFAULT VALUE</b>	FIRLast
<b>EQUIVALENT MENU</b>	<input type="checkbox"/> IQ > IoT > Protocol Type(Z-Wave) > General Settings > Ramp Up/Down Symbol
<b>EXAMPLE</b>	<i>:RADio:ZWAVe:RAMP:MODE CENTer</i> <i>:RADio:ZWAVe:RAMP:MODE?</i> Return: <i>CENTer</i>

#### 3.4.16.3.12 PPDU Length ([:SOURce]:RADio:ZWAVe:PPDU:LENGth?)

<b>SYNTAX</b>	[:SOURce]:RADio:ZWAVe:PPDU:LENGth?
<b>DESCRIPTION</b>	This command queries the PPDU byte length of Z-Wave modulation.
<b>RETURN</b>	Integer, unit: octets
<b>DEFAULT VALUE</b>	54
<b>EQUIVALENT MENU</b>	<input type="checkbox"/> IQ > IoT > Protocol Type(Z-Wave) > PPDU Settings > PPDU Length
<b>EXAMPLE</b>	<i>:RADio:ZWAVe:PPDU:LENGth?</i> Return: <i>53</i>

#### 3.4.16.3.13 Preamble Length ([:SOURce]:RADio:ZWAVe:PREAmble:LENGth)

<b>SYNTAX</b>	[:SOURce]:RADio:ZWAVe:PREAmble:LENGth <val> [:SOURce]:RADio:ZWAVe:PREAmble:LENGth?
<b>DESCRIPTION</b>	This command sets/gets the preamble length of Z-Wave PPDU.
<b>DATA TYPE</b>	Integer, unit: octets
<b>RANGE</b>	10 ~ 100
<b>RETURN</b>	Integer, unit: octets
<b>DEFAULT VALUE</b>	10
<b>EQUIVALENT MENU</b>	<input type="checkbox"/> IQ > IoT > Protocol Type(Z-Wave) > PPDU Settings > Preamble Length
<b>EXAMPLE</b>	<i>:RADio:ZWAVe:PREAmble:LENGth 12</i> <i>:RADio:ZWAVe:PREAmble:LENGth?</i> Return: <i>12</i>

#### 3.4.16.3.14 Start of Frame Delimiter ([:SOURce]:RADio:ZWAVe:SOF)

<b>SYNTAX</b>	[:SOURce]:RADio:ZWAVe:SOF <val> [:SOURce]:RADio:ZWAVe:SOF?
<b>DESCRIPTION</b>	This command sets/gets the frame start field (decimal) of Z-Wave PPDU.
<b>DATA TYPE</b>	Integer

<b>RANGE</b>	0 ~ 255
<b>RETURN</b>	Integer
<b>DEFAULT VALUE</b>	240
<b>EQUIVALENT MENU</b>	<b>IQ</b> > IoT > Protocol Type(Z-Wave) > PPDU Settings > Start of Frame Delimiter(Hex)
<b>EXAMPLE</b>	<i>:RADio:ZWAVe:SOF 100</i> <i>:RADio:ZWAVe:SOF?</i> Return: <i>100\n</i>

#### 3.4.16.3.15 MAC Header State ([:SOURce]:RADio:ZWAVe:MAC:HEADer:STATe)

<b>SYNTAX</b>	<i>[:SOURce]:RADio:ZWAVe:MAC:HEADer:STATe ON OFF 1 0</i> <i>[:SOURce]:RADio:ZWAVe:MAC:HEADer:STATe?</i>
<b>DESCRIPTION</b>	This command sets/queries the enable status of the MAC Header field of Z-Wave PPDU.
<b>DATA TYPE</b>	Boolean
<b>RANGE</b>	ON OFF 1 0
<b>RETURN</b>	1 0
<b>DEFAULT VALUE</b>	1
<b>EQUIVALENT MENU</b>	<b>IQ</b> > IoT > Protocol Type(Z-Wave) > PPDU Settings > MAC Header
<b>EXAMPLE</b>	<i>:RADio:ZWAVe:MAC:HEADer:STATe OFF</i> <i>:RADio:ZWAVe:MAC:HEADer:STATe?</i> Return: <i>0\n</i>

#### 3.4.16.3.16 MAC Header ([:SOURce]:RADio:ZWAVe:MAC:HEADer)

<b>SYNTAX</b>	<i>[:SOURce]:RADio:ZWAVe:MAC:HEADer &lt;"header"&gt;</i> <i>[:SOURce]:RADio:ZWAVe:MAC:HEADer?</i>
<b>DESCRIPTION</b>	This command sets/queries the MAC Header field of Z-Wave frame.
<b>DATA TYPE</b>	String
<b>RANGE</b>	None
<b>RETURN</b>	String
<b>DEFAULT VALUE</b>	12345678,01,3412,2A,01,01
<b>EQUIVALENT MENU</b>	<b>IQ</b> > IoT > Protocol Type(Z-Wave) > PPDU Settings > MAC Header
<b>EXAMPLE</b>	<i>:RADio:ZWAVe:MAC:HEADer "12345678,01,3412,2B,01,AB"</i> <i>:RADio:ZWAVe:MAC:HEADer?</i> Return: <i>12345678,01,3412,2A,01,AB\n</i>



### 3.4.16.3.17 MAC Header Sequence Number State ([:SOURCE]:RADio:ZWAVE:MAC:HEADer:SEQUence:STATe)

<b>SYNTAX</b>	<code>[:SOURCE]:RADio:ZWAVE:MAC:HEADer:SEQUence:STATe ON OFF 1 0</code> <code>[:SOURCE]:RADio:ZWAVE:MAC:HEADer:SEQUence:STATe?</code>
<b>DESCRIPTION</b>	This command sets/queries the enable status of the Sequence Number field in the Z-Wave PPDU MAC Header field.
<b>DATA TYPE</b>	Boolean
<b>RANGE</b>	ON OFF 1 0
<b>RETURN</b>	1 0
<b>DEFAULT VALUE</b>	0
<b>EQUIVALENT MENU</b>	<code>[IQ]</code> > IoT > Protocol Type(Z-Wave) > PPDU Settings > MAC Header > Sequence Number
<b>EXAMPLE</b>	<code>:RADio:ZWAVE:MAC:HEADer:SEQUence:STATe ON</code> <code>:RADio:ZWAVE:MAC:HEADer:SEQUence:STATe?</code> Return: <code>1</code>

### 3.4.16.3.18 Data Type ([:SOURCE]:RADio:ZWAVE:DATA:TYPE)

<b>SYNTAX</b>	<code>[:SOURCE]:RADio:ZWAVE:DATA:TYPE PN9   PN15   USER</code> <code>[:SOURCE]:RADio:ZWAVE:DATA:TYPE?</code>
<b>DESCRIPTION</b>	This command sets/queries the data type of Z-Wave PPDU.
<b>DATA TYPE</b>	Enumeration
<b>RANGE</b>	PN9   PN15   USER
<b>RETURN</b>	Enumeration
<b>DEFAULT VALUE</b>	PN9
<b>EQUIVALENT MENU</b>	<code>[IQ]</code> > IoT > Protocol Type(Z-Wave) > PPDU Settings > Data Type
<b>EXAMPLE</b>	<code>:RADio:ZWAVE:DATA:TYPE PN15</code> <code>:RADio:ZWAVE:DATA:TYPE?</code> Return: <code>PN15</code>

### 3.4.16.3.19 Seed ([:SOURCE]:RADio:ZWAVE:PN:SEED)

<b>SYNTAX</b>	<code>[:SOURCE]:RADio:ZWAVE:PN:SEED &lt;val&gt;</code> <code>[:SOURCE]:RADio:ZWAVE:PN:SEED?</code>
<b>DESCRIPTION</b>	This command sets the seed that generates the PN sequence.
<b>DATA TYPE</b>	Integer
<b>RANGE</b>	1 ~ 32767
<b>RETURN</b>	Integer

<b>DEFAULT VALUE</b>	511
<b>EQUIVALENT MENU</b>	<code>IQ</code> > IoT > Protocol Type(Z-Wave) > PPDU Settings > Seed(Hex)
<b>EXAMPLE</b>	<code>:RADio:ZWAVe:PN:SEED 974</code> <code>:RADio:ZWAVe:PN:SEED?</code> Return: <code>974</code>

#### 3.4.16.3.20 Custom PN Data (`[[:SOURce]:RADio:ZWAVe:PN:USER:DATA]`)

<b>SYNTAX</b>	<code>[[:SOURce]:RADio:ZWAVe:PN:USER:DATA &lt;user_data&gt;</code>
<b>DESCRIPTION</b>	This command sets custom PN data for the Z-Wave PPDU Payload field.
<b>DATA TYPE</b>	Binary string
<b>RANGE</b>	None
<b>EQUIVALENT MENU</b>	<code>IQ</code> > IoT > Protocol Type(Z-Wave) > PPDU Settings > Data Type (User) > User Data
<b>EXAMPLE</b>	<code>:RADio:ZWAVe:PN:USER:DATA 0101001100111</code>

#### 3.4.16.3.21 Get PN Data (`[[:SOURce]:RADio:ZWAVe:PN:DATA?]`)

<b>SYNTAX</b>	<code>[[:SOURce]:RADio:ZWAVe:PN:DATA? PN9   PN15   USER</code>
<b>DESCRIPTION</b>	This command queries the PN data of the Z-Wave PPDU Payload field.
<b>DATA TYPE</b>	Enumeration
<b>RANGE</b>	PN9   PN15   USER
<b>RETURN</b>	Binary string
<b>DEFAULT VALUE</b>	None
<b>EQUIVALENT MENU</b>	<code>IQ</code> > IoT > Protocol Type(Z-Wave) > PPDU Settings > Data Type (User) > User Data
<b>EXAMPLE</b>	<code>:RADio:ZIGBee:PN:DATA? PN9</code> Return: <code>11111111000001111011111000101110011001000001001010011101</code> <code>101000111100111110011011000101010010001110001101101010111</code> <code>000100110001000100000000100001000110000100111001010101100</code> <code>001101111010011011100100010100001010110100111111011001001</code> <code>00101101111100100110101001100110000000110001100101000110</code> <code>10010111111010001011000111010110010110011110001111101110</code> <code>1000001101011011011101100000101101011111010101000000101</code> <code>001010111100101110111000000111001110100100111101011101010</code> <code>0010010000110011100001011110110110011010000111011110000</code>

#### 3.4.16.3.22 Store User PN Data (`[[:SOURce]:RADio:ZWAVe:PN:SAVE]`)

<b>SYNTAX</b>	<code>[[:SOURce]:RADio:ZWAVe:PN:SAVE &lt;"file_name"&gt;</code>
---------------	---

<b>DESCRIPTION</b>	This command saves the customized PN data of the Z-Wave PPDU Payload field into the UDATA file.
<b>DATA TYPE</b>	String
<b>RANGE</b>	Please refer to the user manual for naming rules.
<b>EQUIVALENT MENU</b>	<code>[IQ]</code> > IoT > Protocol Type(Z-Wave) > PPDU Settings > Data Type (User) > User Data > Save
<b>EXAMPLE</b>	<code>:RADio:ZWAVe:PN:SAVE "user_pn.udata"</code>

#### 3.4.16.3.23 Load User PN Data ([:SOURce]:RADio:ZWAVE:PN:LOAD)

<b>SYNTAX</b>	<code>[:SOURce]:RADio:ZWAVE:PN:LOAD &lt;"file_name"&gt;</code>
<b>DESCRIPTION</b>	This command loads the custom PN data of the Z-Wave PPDU Payload field from the UDATA file.
<b>DATA TYPE</b>	String
<b>RANGE</b>	None
<b>EQUIVALENT MENU</b>	<code>[IQ]</code> > IoT > Protocol Type(Z-Wave) > PPDU Settings > Data Type (User) > User Data > Load
<b>EXAMPLE</b>	<code>:RADio:ZWAVe:PN:LOAD "user_pn.udata"</code>

#### 3.4.16.3.24 Data Length ([:SOURce]:RADio:ZWAVE:DATA:LENGth)

<b>SYNTAX</b>	<code>[:SOURce]:RADio:ZWAVE:DATA:LENGth &lt;val&gt;</code> <code>[:SOURce]:RADio:ZWAVE:DATA:LENGth?</code>
<b>DESCRIPTION</b>	This command sets/queries the data length of the Z-Wave PPDU Payload field.
<b>DATA TYPE</b>	Integer, unit: octets
<b>RANGE</b>	Depends on the maximum length of the PSDU and MSDU fields
<b>RETURN</b>	Integer, unit: octets
<b>DEFAULT VALUE</b>	32
<b>EQUIVALENT MENU</b>	<code>[IQ]</code> > IoT > Protocol Type(Z-Wave) > PPDU Settings > Data Length
<b>EXAMPLE</b>	<code>:RADio:ZWAVe:DATA:LENGth 10</code> <code>:RADio:ZWAVe:DATA:LENGth?</code> Return: <code>10\rn</code>

#### 3.4.16.3.25 Data Mode ([:SOURce]:RADio:ZWAVE:CONTInuous:STATe)

<b>SYNTAX</b>	<code>[:SOURce]:RADio:ZWAVE:CONTInuous:STATe ON OFF 1 0</code> <code>[:SOURce]:RADio:ZWAVE:CONTInuous:STATe?</code>
<b>DESCRIPTION</b>	This command enables or disables data continuity status. Continuous mode will have the data bits spread out continuously over multiple frames, truncated mode will have the same payload data bits for all frames.

<b>DATA TYPE</b>	Boolean
<b>RANGE</b>	ON OFF 1 0
<b>RETURN</b>	1 0
<b>DEFAULT VALUE</b>	0
<b>EQUIVALENT MENU</b>	<b>IQ</b> > IoT > Protocol Type(Z-Wave) > PPDU Settings > Data Mode
<b>EXAMPLE</b>	<i>:RADio:ZWAVe:CONTinuous:STATe 1</i> <i>:RADio:ZWAVe:CONTinuous:STATe?</i> Return: <i>1</i>

#### 3.4.16.3.26 MAC FCS State ([:SOURce]:RADio:ZWAVe:FCS:STATe)

<b>SYNTAX</b>	<i>[:SOURce]:RADio:ZWAVe:FCS:STATe ON OFF 1 0</i> <i>[:SOURce]:RADio:ZWAVe:FCS:STATe?</i>
<b>DESCRIPTION</b>	This command enables or disables MAC FCS in the PSDU. When turned off, it can be used to simulate an invalid FCS condition since the FCS section is actually filled with user data bits.
<b>DATA TYPE</b>	Boolean
<b>RANGE</b>	ON OFF 1 0
<b>RETURN</b>	1 0
<b>DEFAULT VALUE</b>	1
<b>EQUIVALENT MENU</b>	<b>IQ</b> > IoT > Protocol Type(Z-Wave) > PPDU Settings > MAC FCS
<b>EXAMPLE</b>	<i>:RADio:ZWAVe:FCS:STATe 0</i> <i>:RADio:ZWAVe:FCS:STATe?</i> Return: <i>0</i>

#### 3.4.16.3.27 End of Frame Delimiter ([:SOURce]:RADio:ZWAVe:EOF:STATe)

<b>SYNTAX</b>	<i>[:SOURce]:RADio:ZWAVe:EOF:STATe ON OFF 1 0</i> <i>[:SOURce]:RADio:ZWAVe:EOF:STATe?</i>
<b>DESCRIPTION</b>	Enable or disable EHR in PPDU. For data rates R2 and R3, this setting is off and read-only.
<b>DATA TYPE</b>	Boolean
<b>RANGE</b>	ON OFF 1 0
<b>RETURN</b>	1 0
<b>DEFAULT VALUE</b>	1
<b>EQUIVALENT MENU</b>	<b>IQ</b> > IoT > Protocol Type(Z-Wave) > PPDU Settings > End of Frame Delimiter
<b>EXAMPLE</b>	<i>:RADio:ZWAVe:EOF:STATe 0</i> <i>:RADio:ZWAVe:EOF:STATe?</i> Return: <i>0</i>

**3.4.16.3.28 Symbol Timing Error ([:SOURce]:RADio:ZWAVE:SYMBle:TIMIng:ERROr)**

<b>SYNTAX</b>	<code>[:SOURce]:RADio:ZWAVE:SYMBle:TIMIng:ERROr &lt;val&gt;</code> <code>[:SOURce]:RADio:ZWAVE:SYMBle:TIMIng:ERROr?</code>
<b>DESCRIPTION</b>	This command sets the shift to the standard symbol rate in ppm.
<b>DATA TYPE</b>	Integer, unit: ppm
<b>RANGE</b>	-300 ~ 300
<b>RETURN</b>	Integer, unit: ppm
<b>DEFAULT VALUE</b>	0
<b>EQUIVALENT MENU</b>	<b>IQ</b> > IoT > Protocol Type(Z-Wave) > Impairments > Symbol Timing Error
<b>EXAMPLE</b>	<code>:RADio:ZWAVE:SYMBle:TIMIng:ERROr -10</code> <code>:RADio:ZWAVE:SYMBle:TIMIng:ERROr?</code> Return: <code>-10\n</code>

**3.4.16.3.29 Frequency Offset ([:SOURce]:RADio:ZWAVE:FREQ:OFFSEt)**

<b>SYNTAX</b>	<code>[:SOURce]:RADio:ZWAVE:FREQ:OFFSEt &lt;val&gt;</code> <code>[:SOURce]:RADio:ZWAVE:FREQ:OFFSEt?</code>
<b>DESCRIPTION</b>	This command sets or gets the offset (in Hz) of the nominal carrier frequency for Z-Wave modulation.
<b>DATA TYPE</b>	Float, unit: Hz
<b>RANGE</b>	-200000 ~ 200000
<b>RETURN</b>	Float, unit: Hz
<b>DEFAULT VALUE</b>	0
<b>EQUIVALENT MENU</b>	<b>IQ</b> > IoT > Protocol Type(Z-Wave) > Impairments > Frequency Offset
<b>EXAMPLE</b>	<code>:RADio:ZWAVE:FREQ:OFFSEt 1000</code> <code>:RADio:ZWAVE:FREQ:OFFSEt?</code> Return: <code>1000\n</code>

**3.4.16.3.30 Frequency Deviation Scaling ([:SOURce]:RADio:ZWAVE:FREQ:DEVIation:SCALE)**

<b>SYNTAX</b>	<code>[:SOURce]:RADio:ZWAVE:FREQ:DEVIation:SCALE &lt;val&gt;</code> <code>[:SOURce]:RADio:ZWAVE:FREQ:DEVIation:SCALE?</code>
<b>DESCRIPTION</b>	Set the additional scale to the nominal FSK frequency deviation, which is equivalent to applying scaling to the FSK modulation index.
<b>DATA TYPE</b>	Float
<b>RANGE</b>	0.5 ~ 1.5
<b>RETURN</b>	Float

<b>DEFAULT VALUE</b>	1
<b>EQUIVALENT MENU</b>	<b>IQ</b> > IoT > Protocol Type(Z-Wave) > Impairments > Frequency Deviation Scaling
<b>EXAMPLE</b>	<i>:RADio:ZWAVe:FREQ:DEVlation:SCALe 0.8</i> <i>:RADio:ZWAVe:FREQ:DEVlation:SCALe?</i> Return: <i>0.8\n</i>

#### 3.4.16.3.31 Gaussian BT ([:SOURce]:RADio:ZWAVe:GAUSSian:BT)

<b>SYNTAX</b>	<i>[:SOURce]:RADio:ZWAVe:GAUSSian:BT &lt;val&gt;</i> <i>[:SOURce]:RADio:ZWAVe:GAUSSian:BT?</i>
<b>DESCRIPTION</b>	This command sets or gets the BT product of the Gaussian filter applied to FSK modulation.
<b>DATA TYPE</b>	Float
<b>RANGE</b>	0.1 ~ 10
<b>RETURN</b>	Float
<b>DEFAULT VALUE</b>	0.6
<b>EQUIVALENT MENU</b>	<b>IQ</b> > IoT > Protocol Type(Z-Wave) > Impairments > Gaussian BT
<b>EXAMPLE</b>	<i>:RADio:ZWAVe:GAUSSian:BT 0.8</i> <i>:RADio:ZWAVe:GAUSSian:BT?</i> Return: <i>0.8\n</i>

#### 3.4.16.3.32 Marker 1 Source ([:SOURce]:RADio:ZWAVe:MARKer:ONE:SOURce)

<b>SYNTAX</b>	<i>[:SOURce]:RADio:ZWAVe:MARKer:ONE:SOURce WAVEform FRAME</i> <i>[:SOURce]:RADio:ZWAVe:MARKer:ONE:SOURce?</i>
<b>DESCRIPTION</b>	This command sets/queries the source of Mark 1 of the Z-Wave modulated wave. Waveform Start - Indicates the start of the waveform, Frame Start - Indicates the beginning of each frame in the waveform.
<b>DATA TYPE</b>	Enumeration
<b>RANGE</b>	WAVEform FRAME
<b>RETURN</b>	Enumeration
<b>DEFAULT VALUE</b>	FRAME
<b>EQUIVALENT MENU</b>	<b>IQ</b> > IoT > Protocol Type(Z-Wave) > Marker > Marker 1 Source
<b>EXAMPLE</b>	<i>:RADio:ZWAVe:MARKer:ONE:SOURce WAVEform</i> <i>:RADio:ZWAVe:MARKer:ONE:SOURce?</i> Return: <i>WAVEform\n</i>

**3.4.16.3.33 Marker 2 Source ([:SOURce]:RADio:ZWAVE:MARKer:TWO:SOURce)**

<b>SYNTAX</b>	<code>[:SOURce]:RADio:ZWAVE:MARKer:TWO:SOURce WAVEform FRAME</code> <code>[:SOURce]:RADio:ZWAVE:MARKer:TWO:SOURce?</code>
<b>DESCRIPTION</b>	This command sets/queries the source of Mark 2 of the Z-Wave modulated wave. Waveform Start - Indicates the start of the waveform, Frame Start - Indicates the beginning of each frame in the waveform.
<b>DATA TYPE</b>	Enumeration
<b>RANGE</b>	WAVEform FRAME
<b>RETURN</b>	Enumeration
<b>DEFAULT VALUE</b>	FRAME
<b>EQUIVALENT MENU</b>	<span style="border: 1px solid black; padding: 2px;">IQ</span> > IoT > Protocol Type(Z-Wave) > Marker > Marker 2 Source
<b>EXAMPLE</b>	<code>:RADio:ZWAVE:MARKer:TWO:SOURce WAVEform</code> <code>:RADio:ZWAVE:MARKer:TWO:SOURce?</code> Return: <code>WAVEform\n</code>

**3.4.16.3.34 Z-Wave Trigger Type ([:SOURce]:RADio:ZWAVE:TRIGger:TYPE)**

<b>SYNTAX</b>	<code>[:SOURce]:RADio:ZWAVE:TRIGger:TYPE CONTInous SINGle GATE</code> <code>[:SOURce]:RADio:ZWAVE:TRIGger:TYPE?</code>
<b>DESCRIPTION</b>	This command sets/queries the trigger type of Z-Wave.
<b>DATA TYPE</b>	Enumeration
<b>RANGE</b>	CONTInous SINGle GATE
<b>RETURN</b>	Enumeration
<b>DEFAULT VALUE</b>	CONTInous
<b>EQUIVALENT MENU</b>	<span style="border: 1px solid black; padding: 2px;">IQ</span> > IoT > Protocol Type(Z-Wave) > Trigger > Trigger Type
<b>EXAMPLE</b>	<code>:RADio:ZWAVE:TRIGger:TYPE SINGle</code> <code>:RADio:ZWAVE:TRIGger:TYPE?</code> Return: <code>SINGle\n</code>

**3.4.16.3.35 Z-Wave Trigger Continuous Mode ([:SOURce]:RADio:ZWAVE:TRIGger:CONTInous)**

<b>SYNTAX</b>	<code>[:SOURce]:RADio:ZWAVE:TRIGger:CONTInous FREErun   RUNIgnored</code> <code>[:SOURce]:RADio:ZWAVE:TRIGger:CONTInous?</code>
<b>DESCRIPTION</b>	This command sets/queries the trigger mode of Z-Wave continuous trigger.
<b>DATA TYPE</b>	Enumeration
<b>RANGE</b>	FREErun   RUNIgnored

<b>RETURN</b>	Enumeration
<b>DEFAULT VALUE</b>	FREErun
<b>EQUIVALENT MENU</b>	[IQ] > IoT > Protocol Type(Z-Wave) > Trigger > Trigger Type(Continuous) > Continuous Mode
<b>EXAMPLE</b>	<i>:RADio:ZWAVe:TRIGger:CONTInous RUNIgnored</i> <i>:RADio:ZWAVe:TRIGger:CONTInous?</i> Return: <i>RUNIgnored\n</i>

#### 3.4.16.3.36 Z-Wave Trigger Gate Mode ([:SOURce]:RADio:ZWAVe:TRIGger:GATE)

<b>SYNTAX</b>	<i>[:SOURce]:RADio:ZWAVe:TRIGger:GATE LOW   HIGH</i> <i>[:SOURce]:RADio:ZWAVe:TRIGger:GATE?</i>
<b>DESCRIPTION</b>	This command sets/queries the trigger mode of Z-Wave external gating trigger.
<b>DATA TYPE</b>	Enumeration
<b>RANGE</b>	LOW   HIGH
<b>RETURN</b>	Enumeration
<b>DEFAULT VALUE</b>	LOW
<b>EQUIVALENT MENU</b>	[IQ] > IoT > Protocol Type(Z-Wave) > Trigger > Trigger Type(Ext Gated) > Gate Mode
<b>EXAMPLE</b>	<i>:RADio:ZWAVe:TRIGger:GATE HIGH</i> <i>:RADio:ZWAVe:TRIGger:GATE?</i> Return: <i>HIGH\n</i>

#### 3.4.16.3.37 Z-Wave Trigger Source ([:SOURce]:RADio:ZWAVe:TRIGger:SOURce)

<b>SYNTAX</b>	<i>[:SOURce]:RADio:ZWAVe:TRIGger:SOURce KEY  BUS  EXT</i> <i>[:SOURce]:RADio:ZWAVe:TRIGger:SOURce?</i>
<b>DESCRIPTION</b>	This command sets/queries the trigger source of Z-Wave trigger.
<b>DATA TYPE</b>	Enumeration
<b>RANGE</b>	KEY  BUS  EXT
<b>RETURN</b>	Enumeration
<b>DEFAULT VALUE</b>	KEY
<b>EQUIVALENT MENU</b>	[IQ] > IoT > Protocol Type(Z-Wave) > Trigger > Trigger Source
<b>EXAMPLE</b>	<i>:RADio:ZWAVe:TRIGger:SOURce BUS</i> <i>:RADio:ZWAVe:TRIGger:SOURce?</i> Return: <i>BUS\n</i>



**3.4.16.3.38 Z-Wave Trigger Polarity ([:SOURce]:RADio:ZWAVE:TRIGger:POL)**

<b>SYNTAX</b>	<code>[:SOURce]:RADio:ZWAVE:TRIGger:POL POS   NEG</code> <code>[:SOURce]:RADio:ZWAVE:TRIGger:POL?</code>
<b>DESCRIPTION</b>	This command sets/queries the trigger polarity of Z-Wave external trigger.
<b>DATA TYPE</b>	Enumeration
<b>RANGE</b>	POS   NEG
<b>RETURN</b>	Enumeration
<b>DEFAULT VALUE</b>	POS
<b>EQUIVALENT MENU</b>	<code>[IQ]</code> > IoT > Protocol Type(Z-Wave) > Trigger > Trigger Source(Ext) > Ext Polarity
<b>EXAMPLE</b>	<code>:RADio:ZWAVE:TRIGger:POL NEG</code> <code>:RADio:ZWAVE:TRIGger:POL?</code> Return: <code>NEG\n</code>

**3.4.16.3.39 Z-Wave Trigger Delay Samples ([:SOURce]:RADio:ZWAVE:TRIGger:DELAy:SAMPlE)**

<b>SYNTAX</b>	<code>[:SOURce]:RADio:ZWAVE:TRIGger:DELAy:SAMPlE &lt;samples&gt;</code> <code>[:SOURce]:RADio:ZWAVE:TRIGger:DELAy:SAMPlE?</code>
<b>DESCRIPTION</b>	This command sets/queries the trigger delay samples of Z-Wave external trigger.
<b>DATA TYPE</b>	Integer
<b>RANGE</b>	0 ~ 100000000
<b>RETURN</b>	Integer
<b>DEFAULT VALUE</b>	0
<b>EQUIVALENT MENU</b>	<code>[IQ]</code> > IoT > Protocol Type(Z-Wave) > Trigger > Trigger Source(Ext) > Delay Samples
<b>EXAMPLE</b>	<code>:RADio:ZWAVE:TRIGger:DELAy:SAMPlE 1000</code> <code>:RADio:ZWAVE:TRIGger:DELAy:SAMPlE?</code> Return: <code>1000\n</code>

**3.4.16.3.40 Z-Wave Bus Trigger ([:SOURce]:RADio:ZWAVE:TRG)**

<b>SYNTAX</b>	<code>[:SOURce]:RADio:ZWAVE:TRG</code>
<b>DESCRIPTION</b>	This command sends a trigger signal of the Z-Wave bus trigger source.
<b>EQUIVALENT MENU</b>	None
<b>EXAMPLE</b>	<code>:RADio:ZWAVE:TRG</code>

### 3.4.17 Multitone

#### 3.4.17.1 Multitone State ([:SOURce]:RADio:MTONe:ARB[:STATe])

<b>SYNTAX</b>	[:SOURce]:RADio:MTONe:ARB[:STATe] ON OFF 1 0 [:SOURce]:RADio:MTONe:ARB[:STATe]?
<b>DESCRIPTION</b>	This command sets/queries the switch status of multi-tone modulation.
<b>DATA TYPE</b>	Boolean
<b>RANGE</b>	ON OFF 1 0
<b>RETURN</b>	1 0
<b>DEFAULT VALUE</b>	0
<b>EQUIVALENT MENU</b>	<input type="checkbox"/> IQ > Multitone > Multitone State
<b>EXAMPLE</b>	<i>:RADio:MTONe:ARB ON</i> <i>:RADio:MTONe:ARB?</i> Return: <i>1</i>

#### 3.4.17.2 Tone Number ([:SOURce]:RADio:MTONe:ARB:SETup:TABLE:NTONes)

<b>SYNTAX</b>	[:SOURce]:RADio:MTONe:ARB:SETup:TABLE:NTONes <num> [:SOURce]:RADio:MTONe:ARB:SETup:TABLE:NTONes?
<b>DESCRIPTION</b>	This command sets/queries the number of tones in the multi-tone waveform.
<b>DATA TYPE</b>	Integer
<b>RANGE</b>	1 ~ 20
<b>RETURN</b>	Integer
<b>DEFAULT VALUE</b>	2
<b>EQUIVALENT MENU</b>	<input type="checkbox"/> IQ > Multitone > Tone Number
<b>EXAMPLE</b>	<i>:RADio:MTONe:ARB:SETup:TABLE:NTONes 5</i> <i>:RADio:MTONe:ARB:SETup:TABLE:NTONes?</i> Return: <i>5</i>

#### 3.4.17.3 Single Side ([:SOURce]:RADio:MTONe:ARB:SETup:TABLE:SINGLE)

<b>SYNTAX</b>	[:SOURce]:RADio:MTONe:ARB:SETup:TABLE:SINGLE ON OFF 1 0 [:SOURce]:RADio:MTONe:ARB:SETup:TABLE:SINGLE?
<b>DESCRIPTION</b>	This command enables or disables multi-tone single-sided.
<b>DATA TYPE</b>	Boolean
<b>RANGE</b>	ON OFF 1 0
<b>RETURN</b>	1 0
<b>DEFAULT VALUE</b>	0

<b>EQUIVALENT MENU</b>	<code>IQ</code> > Multitone > Single Side
<b>EXAMPLE</b>	<code>:RADio:MTONE:ARB:SETup:TABLE:SINgle ON</code> <code>:RADio:MTONE:ARB:SETup:TABLE:SINgle?</code> Return: 1\n

#### 3.4.17.4 Sample Rate (`[[:SOURce]:RADio:MTONE:ARB:SCLock:RATE]`)

<b>SYNTAX</b>	<code>[[:SOURce]:RADio:MTONE:ARB:SCLock:RATE &lt;val&gt;</code> <code>[[:SOURce]:RADio:MTONE:ARB:SCLock:RATE?</code>
<b>DESCRIPTION</b>	This command sets/queries the sampling clock rate for Multitone modulation.
<b>DATA TYPE</b>	Float, unit: Hz, kHz, MHz or GHz, default is Hz
<b>RANGE</b>	500 Hz ~ 240 MHz
<b>RETURN</b>	Float, unit: Hz
<b>DEFAULT VALUE</b>	2 MHz
<b>EQUIVALENT MENU</b>	<code>IQ</code> > Multitone > Sample Rate
<b>EXAMPLE</b>	<code>:RADio:MTONE:ARB:SCLock:RATE 4 MHz</code> <code>:RADio:MTONE:ARB:SCLock:RATE?</code> Return: 4000000\n

#### 3.4.17.5 Freq Spacing (`[[:SOURce]:RADio:MTONE:ARB:SETup:TABLE:FSPacing]`)

<b>SYNTAX</b>	<code>[[:SOURce]:RADio:MTONE:ARB:SETup:TABLE:FSPacing &lt;val&gt;</code> <code>[[:SOURce]:RADio:MTONE:ARB:SETup:TABLE:FSPacing?</code>
<b>DESCRIPTION</b>	This command sets/queries the frequency interval between total tones.
<b>DATA TYPE</b>	Float, unit: Hz, kHz, MHz or GHz, default is Hz
<b>RANGE</b>	Tone Number * Sample Rate /4096 ~ min(120MHz, Sample Rate /1.28)
<b>RETURN</b>	Float, unit: Hz
<b>DEFAULT VALUE</b>	1 MHz
<b>EQUIVALENT MENU</b>	<code>IQ</code> > Multitone > Freq Spacing
<b>EXAMPLE</b>	<code>:RADio:MTONE:ARB:SETup:TABLE:FSPacing 2 MHz</code> <code>:RADio:MTONE:ARB:SETup:TABLE:FSPacing?</code> Return: 2000000\n

#### 3.4.17.6 Save State (`[[:SOURce]:RADio:MTONE:ARB:SETup:STORE]`)

<b>SYNTAX</b>	<code>[[:SOURce]:RADio:MTONE:ARB:SETup:STORE &lt;"file_name"&gt;</code>
<b>DESCRIPTION</b>	This command stores the current multitone settings in a MULSTATE file.

<b>DATA TYPE</b>	String
<b>RANGE</b>	Please refer to the user manual for naming rules.
<b>EQUIVALENT MENU</b>	<span style="border: 1px solid black; padding: 2px;">IQ</span> > Multitone > Save State
<b>EXAMPLE</b>	<i>:RADio:MTONe:ARB:SETup:STORe "test.mulstate"</i>

### 3.4.17.7 Load State ([:SOURce]:RADio:MTONe:ARB:SETup)

<b>SYNTAX</b>	<i>[:SOURce]:RADio:MTONe:ARB:SETup &lt;"file_name"&gt;</i>
<b>DESCRIPTION</b>	This command loads multitone waveform settings from a MULSTATE file.
<b>DATA TYPE</b>	String
<b>RANGE</b>	None
<b>EQUIVALENT MENU</b>	<span style="border: 1px solid black; padding: 2px;">IQ</span> > Multitone > Load State
<b>EXAMPLE</b>	<i>:RADio:MTONe:ARB:SETup "test.mulstate"</i>

## 3.4.18 AWGN

### 3.4.18.1 AWGN State ([:SOURce]:RADio:AWGN:RT[:STATe])

<b>SYNTAX</b>	<i>[:SOURce]:RADio:AWGN:RT[:STATe] ON OFF 1 0 [:SOURce]:RADio:AWGN:RT[:STATe]?</i>
<b>DESCRIPTION</b>	This command sets/queries the switch status of AWGN modulation.
<b>DATA TYPE</b>	Boolean
<b>RANGE</b>	ON OFF 1 0
<b>RETURN</b>	1 0
<b>DEFAULT VALUE</b>	0
<b>EQUIVALENT MENU</b>	<span style="border: 1px solid black; padding: 2px;">IQ</span> > AWGN > AWGN State
<b>EXAMPLE</b>	<i>:RADio:AWGN:RT ON :RADio:AWGN:RT? Return: 1\n</i>

### 3.4.18.2 Bandwidth ([:SOURce]:RADio:AWGN:RT:BWIDth)

<b>SYNTAX</b>	<i>[:SOURce]:RADio:AWGN:RT:BWIDth &lt;bandwidth&gt; [:SOURce]:RADio:AWGN:RT:BWIDth?</i>
<b>DESCRIPTION</b>	This command sets/queries the bandwidth of the real-time AWGN.
<b>DATA TYPE</b>	Float, unit: Hz
<b>RANGE</b>	1 Hz ~ 150 MHz

<b>RETURN</b>	Float, unit: Hz
<b>DEFAULT VALUE</b>	10 MHz
<b>EQUIVALENT MENU</b>	IQ > AWGN > Bandwidth
<b>EXAMPLE</b>	<code>:RADio:AWGN:RT:BWIDth 5000000</code> <code>:RADio:AWGN:RT:BWIDth?</code> Return: <code>5000000\r</code>

## 3.5 SENSE Commands

### 3.5.1 Power Sensor

#### 3.5.1.1 Sensor Info (:SENSe[:POWER]:TYPE?)

<b>SYNTAX</b>	<code>:SENSe[:POWER]:TYPE?</code>
<b>DESCRIPTION</b>	This command queries the model of the power sensor connected to the signal generator.
<b>RETURN</b>	String
<b>DEFAULT VALUE</b>	None
<b>EQUIVALENT MENU</b>	<code>HOME</code> > POWER SENSOR > Sensor Info
<b>EXAMPLE</b>	<code>SENSe:TYPE?</code> Return: <code>NRP6A\r</code>

#### 3.5.1.2 Sensor State (:SENSe[:POWER]:STATus)

<b>SYNTAX</b>	<code>:SENSe[:POWER]:STATus OFF ON 0 1</code> <code>:SENSe[:POWER]:STATus?</code>
<b>DESCRIPTION</b>	This command sets/queries the measurement status of the power sensor.
<b>DATA TYPE</b>	Boolean
<b>RANGE</b>	ON OFF 1 0
<b>RETURN</b>	1 0
<b>DEFAULT VALUE</b>	0
<b>EQUIVALENT MENU</b>	<code>HOME</code> > POWER SENSOR > Sensor State
<b>EXAMPLE</b>	<code>SENSe:STATus ON</code> <code>SENSe:STATus?</code> Return: <code>1\r</code>

**3.5.1.3 Measurement (:SENSe[:POWer]:VALue?)**

<b>SYNTAX</b>	:SENSe[:POWer]:VALue?
<b>DESCRIPTION</b>	This command queries the measured value of the power sensor connected to the signal generator.
<b>RETURN</b>	Float, unit: dBm
<b>DEFAULT VALUE</b>	None
<b>EQUIVALENT MENU</b>	<input type="button" value="HOME"/> > POWER SENSOR > Measurement
<b>EXAMPLE</b>	<i>SENSe:VALue?</i> Return: <i>-0.02600282</i>

**3.5.1.4 Statistics State (:SENSe[:POWer]:STATIStics:STATe)**

<b>SYNTAX</b>	:SENSe[:POWer]:STATIStics:STATe ON OFF 1 0 :SENSe[:POWer]:STATIStics:STATe?
<b>DESCRIPTION</b>	This command sets/queries the measurement statistics status of the power sensor.
<b>DATA TYPE</b>	Boolean
<b>RANGE</b>	ON OFF 1 0
<b>RETURN</b>	1 0
<b>DEFAULT VALUE</b>	0
<b>EQUIVALENT MENU</b>	<input type="button" value="HOME"/> > POWER SENSOR > Statistics
<b>EXAMPLE</b>	<i>SENSe:STATIStics:STATe ON</i> <i>SENSe:STATIStics:STATe?</i> Return: <i>1</i>

**3.5.1.5 Statistics Value (:READ[:POWer]?)**

<b>SYNTAX</b>	:READ[:POWer]?
<b>DESCRIPTION</b>	This command queries the average and maximum values of the power sensor measurement statistics.
<b>RETURN</b>	String The string format: average,maximum Average: float, unit: dBm, Maximum: float, unit: dBm.
<b>DEFAULT VALUE</b>	None
<b>EQUIVALENT MENU</b>	<input type="button" value="HOME"/> > POWER SENSOR > Statistics > mean/max
<b>EXAMPLE</b>	<i>READ?</i> Return: <i>-0.05,-0.04</i>

**3.5.1.6 Statistics Max Value (:SENSe[:POWer]:STATIStics:MAX?)**

<b>SYNTAX</b>	:SENSe[:POWer]:STATIStics:MAX?
<b>DESCRIPTION</b>	This command queries the maximum value of the power sensor measurement statistics.
<b>RETURN</b>	Float, unit: dBm.
<b>DEFAULT VALUE</b>	None
<b>EQUIVALENT MENU</b>	<input type="button" value="HOME"/> > POWER SENSOR > Statistics > max
<b>EXAMPLE</b>	<i>SENSe:STATIStics:MAX?</i> Return: <i>-0.03117205</i>

**3.5.1.7 Statistics Min Value (:SENSe[:POWer]:STATIStics:MIN?)**

<b>SYNTAX</b>	:SENSe[:POWer]:STATIStics:MIN?
<b>DESCRIPTION</b>	This command queries the minimum value of the power sensor measurement statistics.
<b>RETURN</b>	Float, unit: dBm.
<b>DEFAULT VALUE</b>	None
<b>EQUIVALENT MENU</b>	<input type="button" value="HOME"/> > POWER SENSOR > Statistics > min
<b>EXAMPLE</b>	<i>SENSe:STATIStics:MIN?</i> Return: <i>-0.06101395</i>

**3.5.1.8 Statistics Mean Value (:SENSe[:POWer]:STATIStics:AVG?)**

<b>SYNTAX</b>	:SENSe[:POWer]:STATIStics:AVG?
<b>DESCRIPTION</b>	This command queries the average value of the power sensor measurement statistics.
<b>RETURN</b>	Float, unit: dBm.
<b>DEFAULT VALUE</b>	None
<b>EQUIVALENT MENU</b>	<input type="button" value="HOME"/> > POWER SENSOR > Statistics > mean
<b>EXAMPLE</b>	<i>SENSe:STATIStics:AVG?</i> Return: <i>-0.0322136383619456</i>

**3.5.1.9 Statistics Count (:SENSe[:POWer]:STATIStics:COUNT?)**

<b>SYNTAX</b>	:SENSe[:POWer]:STATIStics:COUNT?
<b>DESCRIPTION</b>	This command queries the count of the power sensor measurement statistics.
<b>RETURN</b>	Integer
<b>DEFAULT VALUE</b>	None

<b>EQUIVALENT MENU</b>	<code>[HOME]</code> > POWER SENSOR > Statistics > count
<b>EXAMPLE</b>	<code>SENSe:STATISTICS:COUNT?</code> Return: <code>2035\n</code>

### 3.5.1.10 Statistics Clear (:SENSe[:POWER]:STATISTICS:CLEAr)

<b>SYNTAX</b>	<code>:SENSe[:POWER]:STATISTICS:CLEAr</code>
<b>DESCRIPTION</b>	This command clears the measurement statistics of the power sensor.
<b>EQUIVALENT MENU</b>	<code>[HOME]</code> > POWER SENSOR > Statistics > clear
<b>EXAMPLE</b>	<code>SENSe:STATISTICS:CLEAr</code>

### 3.5.1.11 Level Control (:SENSe[:POWER]:LEV:CTL:STATe)

<b>SYNTAX</b>	<code>:SENSe[:POWER]:LEV:CTL:STATe ON OFF 1 0</code> <code>:SENSe[:POWER]:LEV:CTL:STATe?</code>
<b>DESCRIPTION</b>	This command sets/queries the level control state of the power sensor.
<b>DATA TYPE</b>	Boolean
<b>RANGE</b>	ON OFF 1 0
<b>RETURN</b>	1 0
<b>DEFAULT VALUE</b>	0
<b>EQUIVALENT SCPI</b>	<code>[:SOURce]:POWER:SPC:STATe ON OFF 1 0</code> <code>[:SOURce]:POWER:SPC:STATe?</code>
<b>EQUIVALENT MENU</b>	<code>[HOME]</code> > POWER SENSOR > Level Control
<b>EXAMPLE</b>	<code>:SENSe:LEV:CTL:STATe OFF</code> <code>:SENSe:LEV:CTL:STATe?</code> Return: <code>0\n</code>

### 3.5.1.12 Target Level (:SENSe[:POWER]:SPC:TARGet)

<b>SYNTAX</b>	<code>:SENSe[:POWER]:SPC:TARGet &lt;power&gt;</code> <code>:SENSe[:POWER]:SPC:TARGet?</code>
<b>DESCRIPTION</b>	This command sets/queries the target level of the power sensor level control.
<b>DATA TYPE</b>	Float, unit: dBm, dBuV, uV, mV, V, nW, uW, mW or W, default is dBm
<b>RANGE</b>	-120 dBm ~ 20 dBm
<b>RETURN</b>	Float, unit: dBm
<b>DEFAULT VALUE</b>	0
<b>EQUIVALENT SCPI</b>	<code>[:SOURce]:POWER:SPC:TARGet &lt;power&gt;</code> <code>[:SOURce]:POWER:SPC:TARGet?</code>



<b>EQUIVALENT MENU</b>	<code>[HOME]</code> > POWER SENSOR > Level Control > Target Level
<b>EXAMPLE</b>	<code>SENSe:SPC:TARGet -6</code> <code>SENSe:SPC:TARGet?</code> Return: <code>-6\r</code>

### 3.5.1.13 Limit Level (:SENSe[:POWer]:LIMit)

<b>SYNTAX</b>	<code>:SENSe[:POWer]:LIMit &lt;power&gt;</code> <code>:SENSe[:POWer]:LIMit?</code>
<b>DESCRIPTION</b>	This command sets/queries the Limit level of the power sensor level control.
<b>DATA TYPE</b>	Float, unit: dBm, dBuV, uV, mV, V, nW, uW, mW or W, default is dBm
<b>RANGE</b>	-120 dBm ~ 20 dBm
<b>RETURN</b>	Float, unit: dBm
<b>DEFAULT VALUE</b>	0
<b>EQUIVALENT SCPI</b>	<code>[:SOURce]:POWer:LIMit &lt;power&gt;</code> <code>[:SOURce]:POWer:LIMit?</code>
<b>EQUIVALENT MENU</b>	<code>[HOME]</code> > POWER SENSOR > Level Control > Limit Level
<b>EXAMPLE</b>	<code>SENSe:LIMit 2</code> <code>SENSe:LIMit?</code> Return: <code>2\r</code>

### 3.5.1.14 Catch Range (:SENSe[:POWer]:SPC:CRANge)

<b>SYNTAX</b>	<code>:SENSe[:POWer]:SPC:CRANge &lt;power&gt;</code> <code>:SENSe[:POWer]:SPC:CRANge?</code>
<b>DESCRIPTION</b>	This command sets/queries the catch range of the power sensor level control.
<b>DATA TYPE</b>	Float, unit: dB
<b>RANGE</b>	0 ~ 50
<b>RETURN</b>	Float, unit: dB
<b>DEFAULT VALUE</b>	0
<b>EQUIVALENT SCPI</b>	<code>[SOURce]:POWer:SPC:CRANge &lt;power&gt;</code> <code>[SOURce]:POWer:SPC:CRANge?</code>
<b>EQUIVALENT MENU</b>	<code>[HOME]</code> > POWER SENSOR > Level Control > Catch Range
<b>EXAMPLE</b>	<code>:SENSe:SPC:CRANge 10</code> <code>:SENSe:SPC:CRANge?</code> Return: <code>10\r</code>

**3.5.1.15 Auto Zero (:CALibration:ZERO:TYPE)**

<b>SYNTAX</b>	:CALibration:ZERO:TYPE INTernal EXTernal :CALibration:ZERO:TYPE?
<b>DESCRIPTION</b>	This command sets/queries the automatic zero adjustment type of the power sensor.
<b>DATA TYPE</b>	Enumeration
<b>RANGE</b>	INTernal EXTernal
<b>RETURN</b>	Enumeration
<b>DEFAULT VALUE</b>	INTernal
<b>EQUIVALENT MENU</b>	<input type="button" value="HOME"/> > POWER SENSOR > Auto Zero
<b>EXAMPLE</b>	:CALibration:ZERO:TYPE EXTernal :CALibration:ZERO:TYPE? Return: EXTernal\n

**3.5.1.16 Zeroing (:SENSe[:POWER]:ZERO)**

<b>SYNTAX</b>	:SENSe[:POWER]:ZERO
<b>DESCRIPTION</b>	This command performs a zeroing operation on the power sensor.
<b>EQUIVALENT MENU</b>	<input type="button" value="HOME"/> > POWER SENSOR > Click to perform zeroing
<b>EXAMPLE</b>	:SENSe:ZERO

**3.5.1.17 Frequency Type (:SENSe[:POWER]:SOURce)**

<b>SYNTAX</b>	:SENSe[:POWER]:SOURce RF USER :SENSe[:POWER]:SOURce?
<b>DESCRIPTION</b>	This command sets/queries the measurement frequency type of the power sensor.
<b>DATA TYPE</b>	Enumeration
<b>RANGE</b>	RF USER
<b>RETURN</b>	Enumeration
<b>DEFAULT VALUE</b>	RF
<b>EQUIVALENT MENU</b>	<input type="button" value="HOME"/> > POWER SENSOR > Frequency
<b>EXAMPLE</b>	SENSe:SOURce USER SENSe:SOURce? Return: USER\n

**3.5.1.18 Frequency (:SENSe[:POWER]:FREQuency)**

<b>SYNTAX</b>	:SENSe[:POWER]:FREQuency <freq> :SENSe[:POWER]:FREQuency?
---------------	--

<b>DESCRIPTION</b>	This command sets/queries the manual measurement frequency of the power sensor.
<b>DATA TYPE</b>	Float, unit: Hz, kHz, MHz or GHz, default is Hz
<b>RANGE</b>	Power sensor measurement range
<b>RETURN</b>	Float, unit: Hz
<b>DEFAULT VALUE</b>	None
<b>EQUIVALENT MENU</b>	<input type="button" value="HOME"/> > POWER SENSOR > Frequency
<b>EXAMPLE</b>	<i>SENSe:FREQuency 1 MHz</i> <i>SENSe:FREQuency?</i> Return: <i>1000000\n</i>

### 3.5.1.19 Level Offset State (:SENSe[:POWer]:OFFSet:STATe)

<b>SYNTAX</b>	:SENSe[:POWer]:OFFSet:STATe ON OFF 1 0 :SENSe[:POWer]:OFFSet:STATe?
<b>DESCRIPTION</b>	This command sets/queries the level offset state of the power sensor.
<b>DATA TYPE</b>	Boolean
<b>RANGE</b>	ON OFF 1 0
<b>RETURN</b>	1 0
<b>DEFAULT VALUE</b>	0
<b>EQUIVALENT MENU</b>	<input type="button" value="HOME"/> > POWER SENSOR > Level Offset
<b>EXAMPLE</b>	<i>SENSe:OFFSet:STATe ON</i> <i>SENSe:OFFSet:STATe?</i> Return: <i>1\n</i>

### 3.5.1.20 Level Offset (:SENSe[:POWer]:OFFSet)

<b>SYNTAX</b>	:SENSe[:POWer]:OFFSet <power> :SENSe[:POWer]:OFFSet?
<b>DESCRIPTION</b>	This command sets/queries the level offset value of the power sensor.
<b>DATA TYPE</b>	Float, unit: dB
<b>RANGE</b>	-200 ~ 200
<b>RETURN</b>	Float, unit: dB
<b>DEFAULT VALUE</b>	0
<b>EQUIVALENT MENU</b>	<input type="button" value="HOME"/> > POWER SENSOR > Level Offset
<b>EXAMPLE</b>	<i>SENSe:OFFSet 10</i> <i>SENSe:OFFSet?</i> Return: <i>10\n</i>

**3.5.1.21 Average Type (:SENSe[:POWER]:FILTer:TYPE)**

<b>SYNTAX</b>	:SENSe[:POWER]:FILTer:TYPE AUTO USER NSRatio :SENSe[:POWER]:FILTer:TYPE?
<b>DESCRIPTION</b>	This command sets/queries the measurement averaging type of the power sensor.
<b>DATA TYPE</b>	Enumeration
<b>RANGE</b>	AUTO USER NSRatio
<b>RETURN</b>	Enumeration
<b>DEFAULT VALUE</b>	AUTO
<b>EQUIVALENT MENU</b>	<span style="border: 1px solid black; padding: 2px;">HOME</span> > POWER SENSOR > Averaging
<b>EXAMPLE</b>	<i>SENSe:FILTer:TYPE USER</i> <i>SENSe:FILTer:TYPE?</i> Return: <i>USER</i>

**3.5.1.22 Average Times (:SENSe[:POWER]:FILTer:LENGth)**

<b>SYNTAX</b>	:SENSe[:POWER]:FILTer:LENGth <length> :SENSe[:POWER]:FILTer:LENGth?
<b>DESCRIPTION</b>	This command sets/queries the average number of measurements of the power sensor.
<b>DATA TYPE</b>	Integer
<b>RANGE</b>	1 ~ 65536
<b>RETURN</b>	Integer
<b>DEFAULT VALUE</b>	None
<b>EQUIVALENT MENU</b>	<span style="border: 1px solid black; padding: 2px;">HOME</span> > POWER SENSOR > Averaging Count
<b>EXAMPLE</b>	<i>SENSe:FILTer:LENGth 10</i> <i>SENSe:FILTer:LENGth?</i> Return: <i>10</i>

**3.5.1.23 Internal Noise (:SENSe[:POWER]:FILTer:NSRatio)**

<b>SYNTAX</b>	:SENSe[:POWER]:FILTer:NSRatio <noise> :SENSe[:POWER]:FILTer:NSRatio?
<b>DESCRIPTION</b>	When the measurement averaging type of the power sensor is fixed noise, this command sets/queries the fixed noise of the power sensor.
<b>DATA TYPE</b>	Float, unit: dB
<b>RANGE</b>	None
<b>RETURN</b>	Float, unit: dB
<b>DEFAULT VALUE</b>	None

<b>EQUIVALENT MENU</b>	<code>[HOME]</code> > POWER SENSOR > Internal Noise
<b>EXAMPLE</b>	<code>SENSe:FILTer:NSRatio 1</code> <code>SENSe:FILTer:NSRatio?</code> Return: <code>1\n</code>

### 3.5.1.24 Logging (:SENSe[:POWer]:LOGGing:STATe)

<b>SYNTAX</b>	<code>:SENSe[:POWer]:LOGGing:STATe ON OFF 1 0</code> <code>:SENSe[:POWer]:LOGGing:STATe?</code>
<b>DESCRIPTION</b>	This command sets/queries the logging status of the power sensor.
<b>DATA TYPE</b>	Boolean
<b>RANGE</b>	ON OFF 1 0
<b>RETURN</b>	1 0
<b>DEFAULT VALUE</b>	0
<b>EQUIVALENT MENU</b>	<code>[HOME]</code> > POWER SENSOR > Logging
<b>EXAMPLE</b>	<code>SENSe:LOGGing:STATe ON</code> <code>SENSe:LOGGing:STATe?</code> Return: <code>1\n</code>

## 3.6 MEMoryCommands

### 3.6.1 ARB

#### 3.6.1.1 Save Segment (:MEMory:COpy[:NAME])

<b>SYNTAX</b>	<code>:MEMory:COpy[:NAME] &lt;"segment"&gt;,&lt;"file_name"&gt;</code>
<b>DESCRIPTION</b>	Copy a waveform segment file from volatile memory to non-volatile memory
<b>DATA TYPE</b>	String, string
<b>RANGE</b>	segment: waveform name in <code>[IQ]</code> > ARB > Waveform Segment, file_name: ARB file name to save. Please refer to the user manual for naming rules.
<b>EQUIVALENT MENU</b>	<code>[IQ]</code> > ARB > Waveform Segment > Save
<b>EXAMPLE</b>	<code>:MEMory:COpy "SINE_WAVE","SINE_test.arb"</code>

#### 3.6.1.2 Create Segment (:MEM:DATA)

<b>SYNTAX</b>	<code>:MEM:DATA &lt;"file_name"&gt;,&lt;data_block&gt;</code>
<b>DESCRIPTION</b>	This command loads waveform data into signal generator memory using the <data_block> parameter and saves the waveform data into a file specified by the <"file_name"> variable.

<b>DATA TYPE</b>	file_name: string. This variable names the destination file, including the directory path. data_block: string. This parameter represents the data and file length parameters. The data in the file is represented by the variable.
<b>RANGE</b>	file_name: please refer to the user manual for naming rules. data_block: none.
<b>EQUIVALENT MENU</b>	None
<b>EXAMPLE</b>	<i>:MEM:DATA "IQ_Data.arb",#14Y9oL</i>
	<p><b>Note:</b>  #14Y9oL - Data block  # - This character indicates the beginning of the data block  1 - Number of digits in the byte count  4 - Byte count  Y9oL - 4 bytes of data (ascii representation of bit data)</p>

### 3.6.1.3 Load User Bit Data (:MEM:DATA:BIT)

<b>SYNTAX</b>	:MEM:DATA:BIT <"file_name">,<bit_count>,<data_block>
<b>DESCRIPTION</b>	This command loads bit data into signal generator memory using the <bit_count> and <data_block> parameters and saves the data to a file designated by the <"file_name"> variable.
<b>DATA TYPE</b>	file_name: string. This variable names the destination file and the directory path.  bit_count: integer. This number represents the number of bits in the data block.  data_block: string. This parameter represents the data and file length parameters. The data in the file is represented by the variable. The file length parameters are used by the signal generator for allocating memory.
<b>RANGE</b>	file_name: please refer to the user manual for naming rules. bit_count: none. data_block: none.
<b>EQUIVALENT MENU</b>	None
<b>EXAMPLE</b>	<i>:MEM:DATA:BIT "Test_Data.udata",16,#12Qz</i>
	<p><b>Note:</b>  #12Qz - Data block  # - This character indicates the beginning of the data block  1 - Number of digits in the byte count  2 - Byte count  Qz - 16 bits of data (ascii representation of bit data)</p>

## 4 Programming Examples

This chapter provides some examples for programmers. In these examples you can see how to use VISA or Sockets and the above SCPI commands to control a signal generator. By following these examples, you can develop more applications.

### 4.1 VISA Examples

#### 4.1.1 VC++ Example

**System environment:** Windows 10, 64-bit operating system

**Programming software:** Visual Studio

**Example content:** Use NI-VISA to access and control the device through USBTMC or TCP/IP and perform read and write operations.

Please follow below steps to complete the example:

1. Open Visual Studio, and create a new VC++ win32 console project.
2. Set up the project environment to use the NI-VISA library. There are two ways to use the NI-VISA library, static or automatic:

(1) Static:

Find the files in the NI-VISA installation path: visa.h, visatype.h, visa32.lib. The default installation path of NI-VISA is "C:\Program Files\IVI Foundation\VISA\Win64\". Copy the above files into your project and add them to the project. Then add the following two lines of code in the project.cpp file:

```
#include "visa.h"  
#pragma comment(lib,"visa32.lib")
```

(2) Automatic:

Set the include directory for header files. The default installation path of NI-VISA header files is "C:\Program Files\IVI Foundation\VISA\Win64\Include". Fill in the header file installation path in Project --- Properties --- C/C++ --- General --- Additional Include Directories, as shown below:

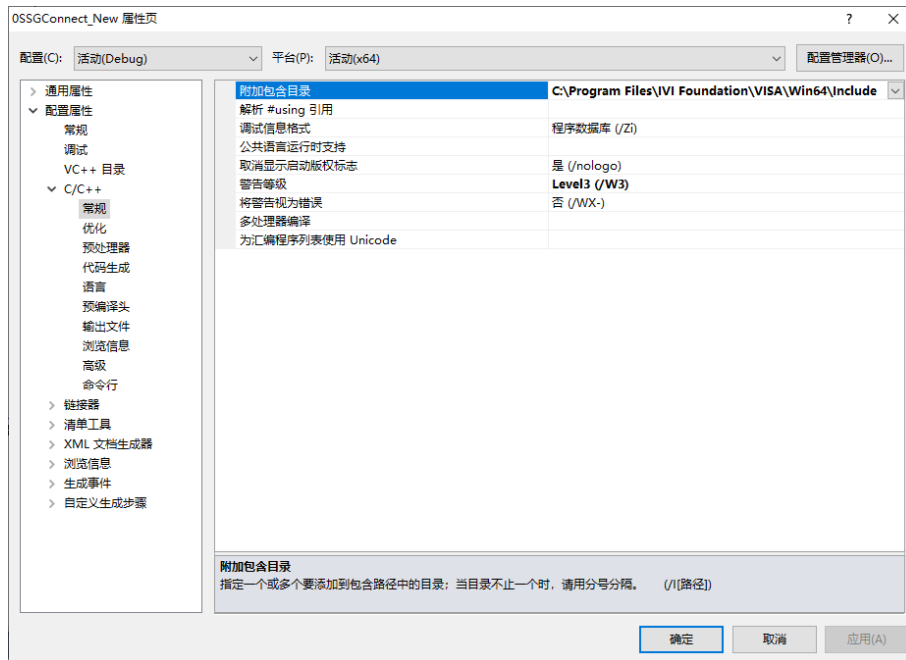

Set the include directory of library files. The default installation path of NI-VISA library files is "C:\Program Files\IVI Foundation\VISA\Win64\Lib\_x64\msc". Fill in the library file installation path in Project --- Properties --- Linker --- General --- Additional library directory, as shown below:

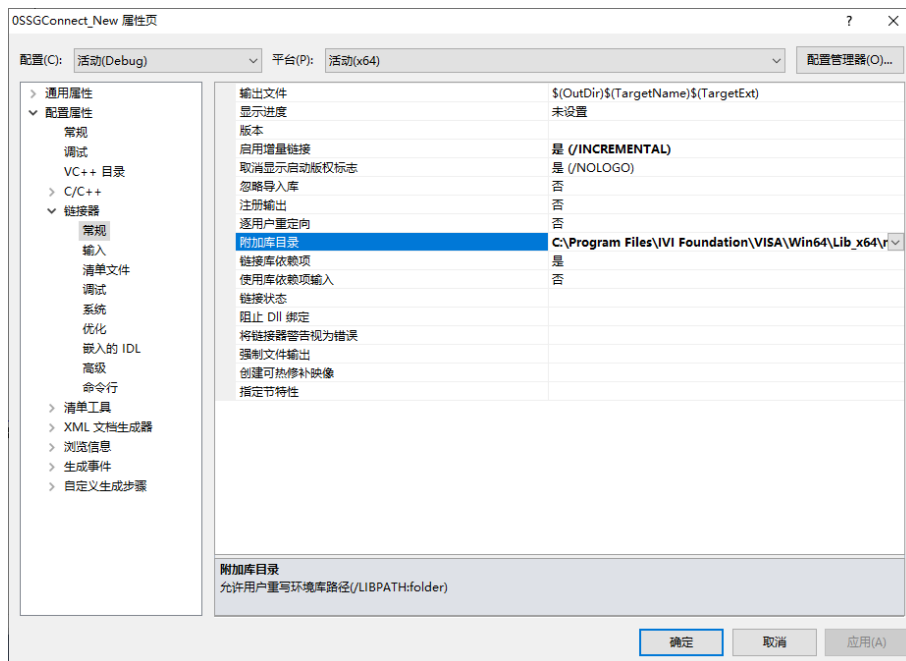

Set up library files. Fill in the library file name in Project --- Properties --- Linker --- Command Line --- Additional Options: visa32.lib, as shown below:



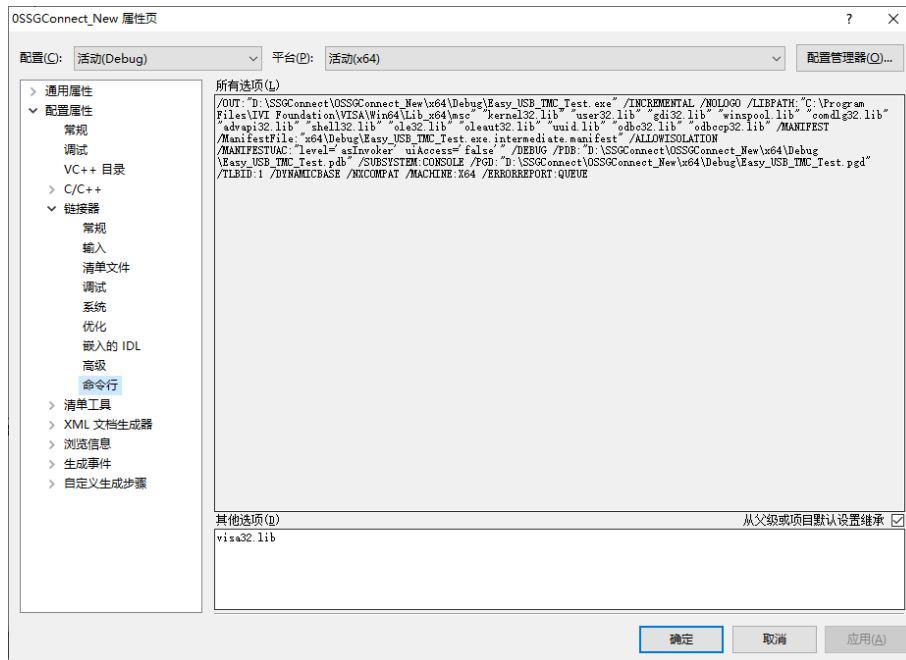

Finally, reference the header file in the project .cpp file:

```
#include <visa.h>
```

### 3. Add code

#### (1) USBTMC access code

Write a function Usbtmc\_test:

```
int Usbtmc_test()
{
    /* This code demonstrates sending synchronous read & write commands */
    /* to an USB Test & Measurement Class (USBTMC) instrument using */
    /* NI-VISA */
    /* The example writes the "**IDN?\n" string to all the USBTMC */
    /* devices connected to the system and attempts to read back */
    /* results using the write and read functions. */
    /* The general flow of the code is */
    /* Open Resource Manager */
    /* Open VISA Session to an Instrument */
    /* Write the Identification Query Using viPrintf */
    /* Try to Read a Response With viScanf */
    /* Close the VISA Session */
    /*****/
    ViSession defaultRM;
    ViSession instr;
    ViUInt32 numInstrs;
    ViFindList findList;
    ViStatus status;
    char instrResourceString[VI_FIND_BUFLen];
```

```
unsigned char buffer[100];
int i;
/** First we must call viOpenDefaultRM to get the manager
 * handle. We will store this handle in defaultRM.*/
status = viOpenDefaultRM (&defaultRM);
if (status<VI_SUCCESS)
{
    printf ("Could not open a session to the VISA Resource Manager!\n");
    return status;
}
/* Find all the USB TMC VISA resources in our system and store the number of resources in the system in
numInstrs.*/
status = viFindRsrc (defaultRM, "USB?*INSTR", &findList, &numInstrs, instrResourceString);
if (status<VI_SUCCESS)
{
    printf ("An error occurred while finding resources.\nPress 'Enter' to continue.");
    fflush(stdin);
    getchar();
    viClose (defaultRM);
    return status;
}
/** Now we will open VISA sessions to all USB TMC instruments.
 * We must use the handle from viOpenDefaultRM and we must
 * also use a string that indicates which instrument to open. This
 * is called the instrument descriptor. The format for this string
 * can be found in the function panel by right clicking on the
 * descriptor parameter. After opening a session to the
 * device, we will get a handle to the instrument which we
 * will use in later VISA functions. The AccessMode and Timeout
 * parameters in this function are reserved for future
 * functionality. These two parameters are given the value VI_NULL.*/
for (i=0; i<int(numInstrs); i++)
{
    if (i> 0)
    {
        viFindNext (findList, instrResourceString);
    }
    status = viOpen (defaultRM, instrResourceString, VI_NULL, VI_NULL, &instr);
    if (status<VI_SUCCESS)
    {
        printf ("Cannot open a session to the device %d.\n", i+1);
        continue ;
    }
    /* * At this point we now have a session open to the USB TMC instrument.
     * We will now use the viPrintf function to send the device the string "*IDN?\n",
```

```

    * asking for the device's identification. */
    char * ccommand = "*IDN?\n";
    status = viPrintf (instr, ccommand);
    if (status<VI_SUCCESS)
    {
        printf ("Error writing to the device %d.\n", i+1);
        status = viClose (instr);
        continue;
    }
    /** Now we will attempt to read back a response from the device to
    * the identification query that was sent. We will use the viScanf
    * function to acquire the data.
    * After the data has been read the response is displayed. */
    status = viScanf(instr, "%t", buffer);
    if (status<VI_SUCCESS)
    {
        printf ("Error reading a response from the device %d.\n", i+1);
    }
    else
    {
        printf ("\nDevice %d: %s\n", i+1, buffer);
    }
    status = viClose (instr);
}

/** Now we will close the session to the instrument using
* viClose. This operation frees all system resources. */
status = viClose (defaultRM);
printf("Press 'Enter' to exit.");
fflush(stdin);
getchar();
return 0;
}

int _tmain(int argc, _TCHAR* argv[])
{
    Usbtmc_test();
    return 0;
}

```

### The running result:

```

C:\Users\Administrator\Desktop\USB_TMC_Test.exe
Device 1: Siglent Technologies, SSG5060X-V, SSG5XCAX4R0015, V1.1.1.1.9c
Press 'Enter' to exit.

```

## (2) TCP/IP access code

Write a function TCP\_IP\_Test:

```
int TCP_IP_Test(char *pIP)
{
    char outputBuffer[VI_FIND_BUFLLEN];
    ViSession defaultRM, instr;
    ViStatus status;

    /* First we will need to open the default resource manager. */
    status = viOpenDefaultRM (&defaultRM);
    if (status<VI_SUCCESS)
    {
        printf("Could not open a session to the VISA Resource Manager!\n");
    }
    /* Now we will open a session via TCP/IP device */
    char head[256] = "TCPIP0:.";
    char tail[] = "::INSTR";

    strcat(head,pIP);
    strcat(head,tail);
    status = viOpen (defaultRM, head, VI_LOAD_CONFIG, VI_NULL, &instr);
    if (status<VI_SUCCESS)
    {
        printf ("An error occurred opening the session\n");
        viClose(defaultRM);
    }
    status = viPrintf(instr, "**idn?\n");
    if (status<VI_SUCCESS)
    {
        printf("Error writing to the device.\n");
        viClose(defaultRM);
    }
    status = viScanf(instr, "%t", outputBuffer);
    if (status<VI_SUCCESS)
    {
        printf("viRead failed with error code: %x \n",status);
        viClose(defaultRM);
    }
    else
    {
        printf ("\nMessage read from device: %*s\n", 0,outputBuffer);
    }
    status = viClose (instr);
    status = viClose (defaultRM);
    printf("Press 'Enter' to exit.");
}
```

```
    fflush(stdin);
    getchar();
    return 0;
}

int _tmain(int argc, _TCHAR* argv[])
{
    printf("Please input IP address:");
    char ip[256];
    fflush(stdin);
    gets(ip);
    TCP_IP_Test(ip);
    return 0;
}
```

### The running result:

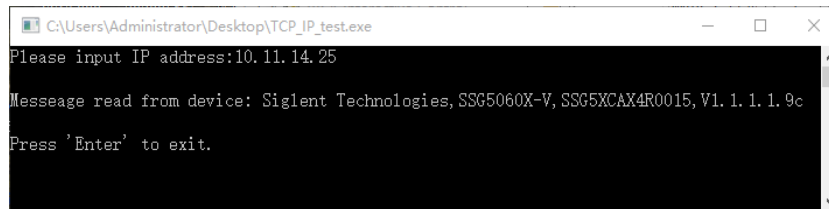

```
C:\Users\Administrator\Desktop\TCP_IP_test.exe
Please input IP address:10.11.14.25
Message read from device: Siglent Technologies, SSG5060X-V, SSG5XCAX4R0015, V1.1.1.1.9c
Press 'Enter' to exit.
```

## 4.1.2 VB Example

**System environment:** Windows 7

**Programming software:** Microsoft Visual Basic 6.0

**Example content:** Use NI-VISA to access and control the device through USBTMC or TCP/IP and perform read and write operations.

Please follow below steps to complete the example:

1. Open Visual Basic and build a standard application program project (standard EXE).
2. Set up the project environment to use the NI-VISA library. Click the Existing tag of Project >> Add Existing Item, search for the visa32.bas file in the include folder under the NI-VISA installation path and add the file. This will enable VISA functions and VISA data types to be used in the program.

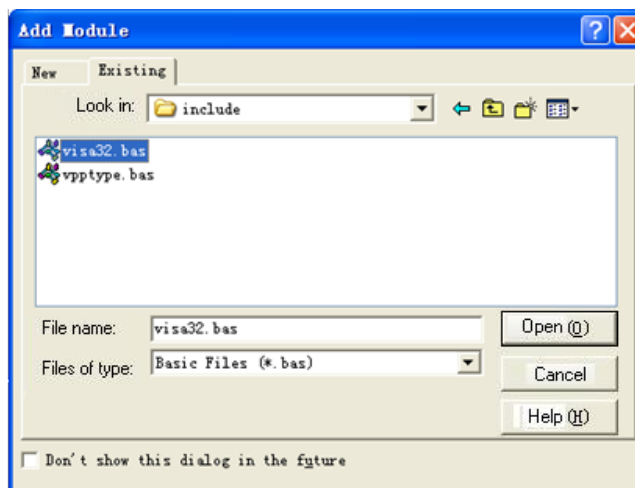

3. Add code

(1) USBTMC access code

Write a function Usbtmc\_test:

```
Private Function Usbtmc_test() As Long
```

```

' This code demonstrates sending synchronous read & write commands
' to an USB Test & Measurement Class (USBTMC) instrument using
' NI-VISA
' The example writes the "*IDN?\n" string to all the USBTMC
' devices connected to the system and attempts to read back
' results using the write and read functions.
' The general flow of the code is
' Open Resource Manager
' Open VISA Session to an Instrument
' Write the Identification Query Using viWrite
' Try to Read a Response With viRead
' Close the VISA Session

```

```
Const MAX_CNT = 200

Dim defaultRM As Long
Dim instrsesn As Long
Dim numInstrs As Long
Dim findList As Long
Dim retCount As Long

Dim status As Long
Dim instrResourceString As String * VI_FIND_BUFLen
Dim Buffer As String * MAX_CNT
Dim i As Integer
' First we must call viOpenDefaultRM to get the manager
' handle. We will store this handle in defaultRM.
status = viOpenDefaultRM(defaultRM)
If (status < VI_SUCCESS) Then
    resultTxt.Text = "Could not open a session to the VISA Resource Manager!"
    Usbtmc_test = status
    Exit Function
End If

' Find all the USB TMC VISA resources in our system and store the
' number of resources in the system in numInstrs.
status = viFindRsrc(defaultRM, "USB?*INSTR", findList, numInstrs, instrResourceString)
If (status < VI_SUCCESS) Then
    resultTxt.Text = "An error occurred while finding resources."
    viClose(defaultRM)
    Usbtmc_test = status
    Exit Function
End If

' Now we will open VISA sessions to all USB TMC instruments.
' We must use the handle from viOpenDefaultRM and we must
' also use a string that indicates which instrument to open. This
' is called the instrument descriptor. The format for this string
' can be found in the function panel by right clicking on the
' descriptor parameter. After opening a session to the
' device, we will get a handle to the instrument which we
' will use in later VISA functions. The AccessMode and Timeout
' parameters in this function are reserved for future
' functionality. These two parameters are given the value VI_NULL.
For i = 0 To numInstrs
    If (i > 0) Then
        status = viFindNext(findList, instrResourceString)
    End If
```

```

status = viOpen(defaultRM, instrResourceString, VI_NULL, VI_NULL, instrsesn)
If (status < VI_SUCCESS) Then
    resultTxt.Text = "Cannot open a session to the device " + CStr(i + 1)
    GoTo NextFind
End If

' At this point we now have a session open to the USB TMC instrument.
' We will now use the viWrite function to send the device the string "*IDN?",
' asking for the device's identification.
status = viWrite(instrsesn, "*IDN?", 5, retCount)
If (status < VI_SUCCESS) Then
    resultTxt.Text = "Error writing to the device."
    status = viClose(instrsesn)
    GoTo NextFind
End If

' Now we will attempt to read back a response from the device to
' the identification query that was sent. We will use the viRead
' function to acquire the data.
' After the data has been read the response is displayed.
status = viRead(instrsesn, Buffer, MAX_CNT, retCount)
If (status < VI_SUCCESS) Then
    resultTxt.Text = "Error reading a response from the device." + CStr(i + 1)
Else
    resultTxt.Text = "read from device: " + CStr(i + 1) + " " + Buffer
End If
status = viClose(instrsesn)

Next i

' Now we will close the session to the instrument using
' viClose. This operation frees all system resources.
status = viClose(defaultRM)
Usbtmc_test = 0

```

End Function

## (2) TCP/IP access code

Write a function TCP\_IP\_Test:

```

Private Function TCP_IP_Test(ByVal ip As String) As Long
    Dim outputBuffer As String * VI_FIND_BUFLLEN
    Dim defaultRM As Long
    Dim instrsesn As Long
    Dim status As Long

```



```
Dim count As Long
```

```
' First we will need to open the default resource manager.
```

```
status = viOpenDefaultRM(defaultRM)
```

```
If (status < VI_SUCCESS) Then
```

```
    resultTxt.Text = "Could not open a session to the VISA Resource Manager!"
```

```
    TCP_IP_Test = status
```

```
    Exit Function
```

```
End If
```

```
' Now we will open a session via TCP/IP device
```

```
status = viOpen(defaultRM, "TCPIP0::" + ip + "::INSTR", VI_LOAD_CONFIG, VI_NULL, instrsesn)
```

```
If (status < VI_SUCCESS) Then
```

```
    resultTxt.Text = "An error occurred opening the session"
```

```
    viClose(defaultRM)
```

```
    TCP_IP_Test = status
```

```
    Exit Function
```

```
End If
```

```
status = viWrite(instrsesn, "**IDN?", 5, count)
```

```
If (status < VI_SUCCESS) Then
```

```
    resultTxt.Text = "Error writing to the device."
```

```
End If
```

```
status = viRead(instrsesn, outputBuffer, VI_FIND_BUFLEN, count)
```

```
If (status < VI_SUCCESS) Then
```

```
    resultTxt.Text = "Error reading a response from the device." + CStr(i + 1)
```

```
Else
```

```
    resultTxt.Text = "read from device:" + outputBuffer
```

```
End If
```

```
status = viClose(instrsesn)
```

```
status = viClose(defaultRM)
```

```
TCP_IP_Test = 0
```

```
End Function
```

(3) Button control code:

```
Private Sub exitBtn_Click()
```

```
    End
```

```
End Sub
```

```
Private Sub tcpipBtn_Click()
```

```
    Dim stat As Long
```

```
    stat = TCP_IP_Test(ipTxt.Text)
```

```
    If (stat < VI_SUCCESS) Then
```

```
        resultTxt.Text = Hex(stat)
```

```
    End If
```

```
End Sub
Private Sub usbBtn_Click()
    Dim stat As Long
    stat = Usbtmc_test
    If (stat < VI_SUCCESS) Then
        resultTxt.Text = Hex(stat)
    End If
End Sub
```

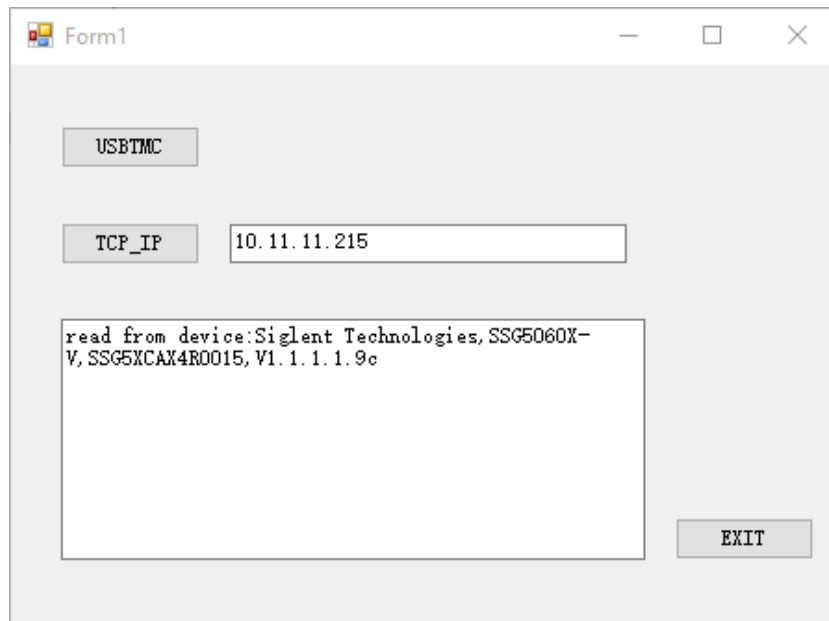
**The running result:**

### 4.1.3 MATLAB Example

**System environment:** Windows 7

**Programming software:** MATLAB R2013a

**Example content:** Use NI-VISA to access and control the device through USBTMC or TCP/IP and perform read and write operations.

Please follow below steps to complete the example:

1. Open MATLAB and modify the current directory. In this example, change the current directory to D:\USBTMC\_TCPIP\_Demo.
2. Click File>>New>>Script in the MATLAB interface to create an empty M document.
3. Add code

(1) USBTMC access code

Write a function Usbtmc\_test:

```
function Usbtmc_test()
% This code demonstrates sending synchronous read & write commands
% to an USB Test & Measurement Class (USBTMC) instrument using
% NI-VISA

%Create a VISA-USB object connected to a USB instrument
vu = visa('ni','USB0::0xF4EC::0x1501::0123456789::INSTR');

%Open the VISA object created
fopen(vu);

%Send the string "**IDN?",asking for the device's identification.
fprintf(vu,'*IDN?');

%Request the data
outputbuffer = fscanf(vu);
disp(outputbuffer);

%Close the VISA object
fclose(vu);
delete(vu);
clear vu;

end
```

**The running result:**

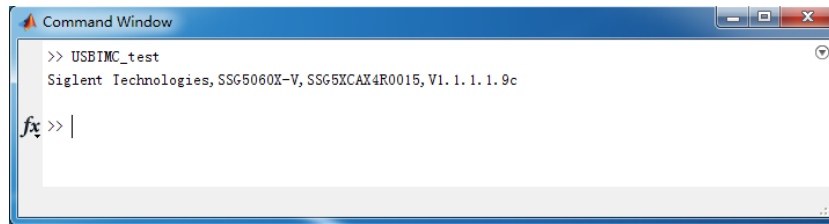

```

>> USBMC_test
Siglent Technologies, SSG5060X-V, SSG5XCAX4R0015, V1.1.1.1.9c
fx >> |

```

## (2) TCP/IP access code

Write a function TCP\_IP\_Test:

```

function TCP_IP_test()
% This code demonstrates sending synchronous read & write commands
% to an TCP/IP instrument using NI-VISA

%Create a VISA-TCPIP object connected to an instrument
%configured with IP address.
vt = visa('ni',['TCPIP0::','10.11.11.215', '::INSTR']);

%Open the VISA object created
fopen(vt);

%Send the string "**IDN?",asking for the device's identification.
fprintf(vt, '*IDN?');

%Request the data
outputbuffer = fscanf(vt);
disp(outputbuffer);

%Close the VISA object
fclose(vt);
delete(vt);
clear vt;

end

```

**The running result:**

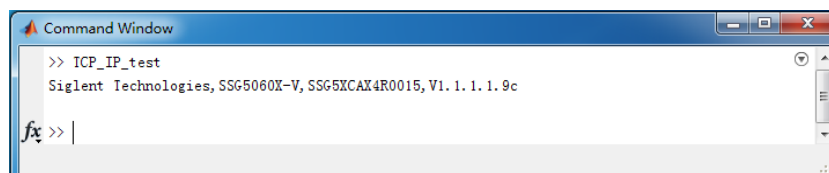

```

>> TCP_IP_test
Siglent Technologies, SSG5060X-V, SSG5XCAX4R0015, V1.1.1.1.9c
fx >> |

```

#### 4.1.4 LabVIEW Example

**System environment:** Windows 7

**Programming software:** LabVIEW 2011

**Example content:** Use NI-VISA to access and control the device through USBTMC or TCP/IP and perform read and write operations.

Please follow below steps to complete the example:

1. Open LabVIEW and create a VI file.
2. Add controls. Right-click the front panel interface, select and add VISA resource name, error input, error out and some indicators in the controls column.
3. Open the block diagram interface. Right-click the VISA resource name and select from the shortcut menu of the VISA palette to add the following functions: VISA Write, VISA Read, VISA Open and VISA Close.
4. Connect them as shown in the figure below:

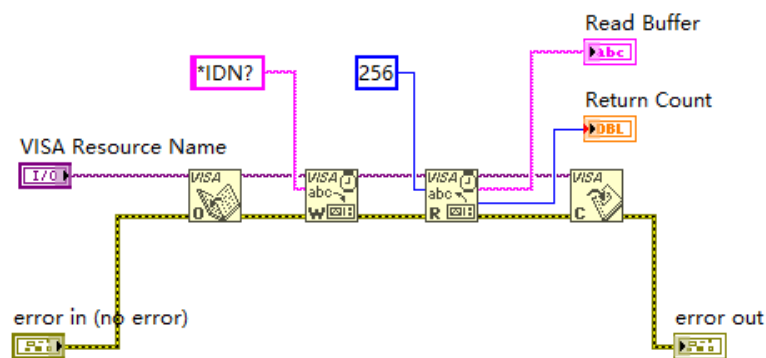

5. Select the device resource from the VISA resource name list box and run the program.

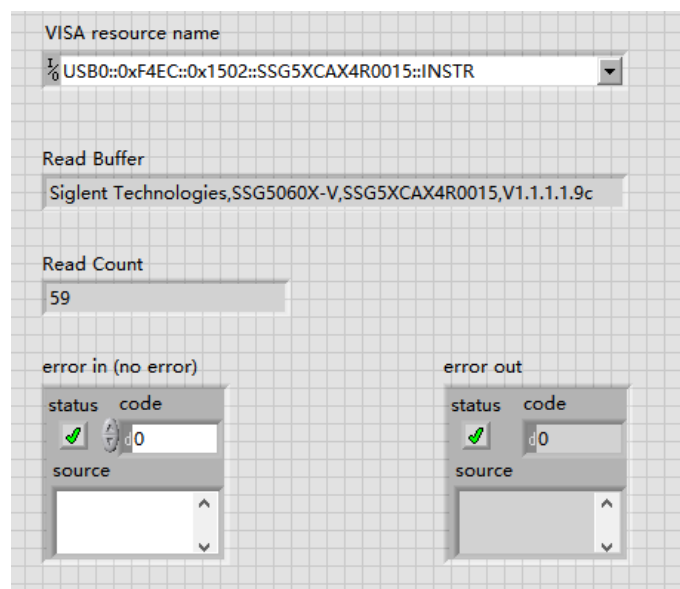

In this example, the VI opens a VISA session to the USBTMC device, writes a command to the device, and then reads back the response. In this example, the specific command sent is a device ID query. Please check the device command set with your device manufacturer. After all communication is complete, the VI closes the VISA session.

Communicating with the device over TCP/IP is similar to USBTMC. However, you need to change the VISA write and VISA read functions to synchronize the I/O. LabVIEW's default is asynchronous I/O. Right-click the node and select Synchronous I/O Mode>>Sync from the shortcut menu to write or read synchronized data.

1. Connect them as shown in the figure below:

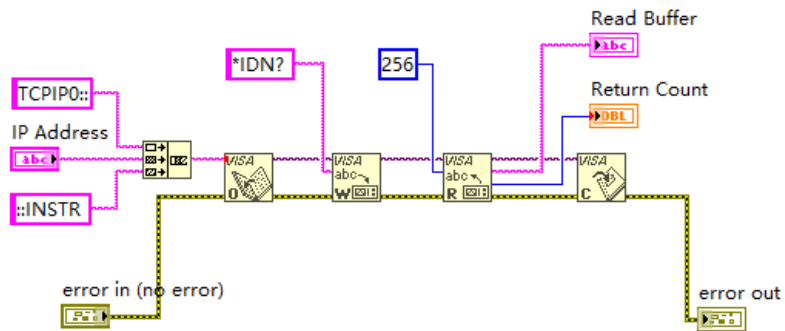

2. Enter the IP address and run the program:

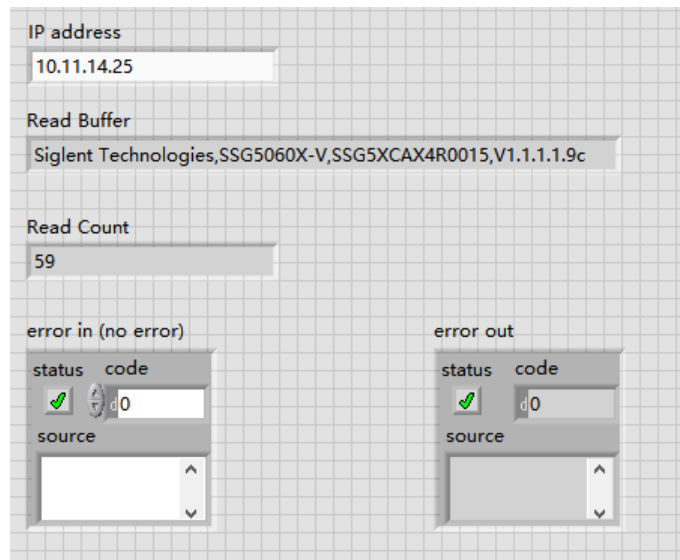

## 4.2 Socket Examples

The Windows operating system itself supports Sockets communication, and this communication method is also relatively simple. It should be noted that "\n" (newline character) needs to be added to the end of the SCPI command string.

### 4.2.1 Python Example

Python is an interpreted programming language that allows you to work quickly and is very portable. Python has an underlying network module that provides access to the Socket interface, port 5025. Python scripts can be written for the Socket interface to perform various test and measurement tasks.

**System environment:** Windows 10, 64-bit operating system

**Programming software:** Python v3.6.5

**Example content:** Open a Socket, send a SCPI query, then close the Socket, loop ten times.

Below is the code of the script:

```
#!/usr/bin/env python
#-*- coding:utf-8 -*-
#-----
# The short script is an example that open a socket, sends a query,
# print the return message and closes the socket.
#-----
import socket # for sockets
import sys # for exit
import time # for sleep
#-----
remote_ip = "10.11.22.27" # should match the instrument's IP address
port = 5025 # the port number of the instrument service

def SocketConnect():
    try:
        #create an AF_INET, STREAM socket (TCP)
        s = socket.socket(socket.AF_INET, socket.SOCK_STREAM)
    except socket.error:
        input ('Failed to create socket. \nPress "Enter" to exit: ')
        sys.exit()
    try:
        #Connect to remote server
        s.connect((remote_ip , port))
```

```
except socket.error:
    input('Failed to connect to ip %s!\nPress "Enter" to exit: ' % remote_ip)
    s.close()
    sys.exit()
return s

def SocketQuery(Sock, cmd):
    try :
        #Send cmd string
        Sock.sendall(cmd)
        time.sleep(1)
    except socket.error:
        #Send failed
        input('Send failed!\nPress "Enter" to exit: ')
        SocketClose(Sock)
        sys.exit()
    reply = Sock.recv(4096)
    reply = reply.decode()
    return reply

def SocketClose(Sock):
    #close the socket
    Sock.close()
    time.sleep(.300)

def main():
    # Body: send the SCPI commands *IDN? 10 times and print the return message
    s = SocketConnect()

    count = 0
    for i in range(10):
        qStr = SocketQuery(s, b'*IDN?\n')
        print (str(count) + ":: " + qStr)
        count = count + 1
    SocketClose(s)
    input('Press "Enter" to exit')

if __name__ == '__main__':
    main()
```

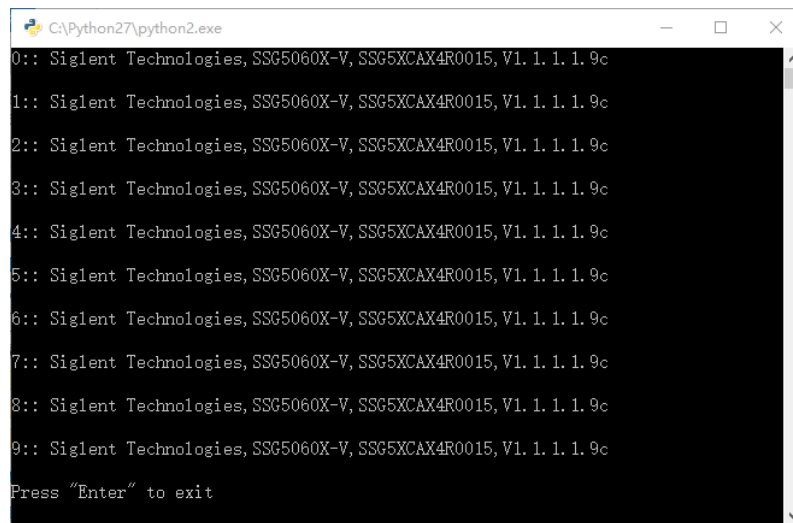

**The running result:**

```
C:\Python27\python2.exe
0:: Siglent Technologies, SSG5060X-V, SSG5XCAX4R0015, V1.1.1.1.9c
1:: Siglent Technologies, SSG5060X-V, SSG5XCAX4R0015, V1.1.1.1.9c
2:: Siglent Technologies, SSG5060X-V, SSG5XCAX4R0015, V1.1.1.1.9c
3:: Siglent Technologies, SSG5060X-V, SSG5XCAX4R0015, V1.1.1.1.9c
4:: Siglent Technologies, SSG5060X-V, SSG5XCAX4R0015, V1.1.1.1.9c
5:: Siglent Technologies, SSG5060X-V, SSG5XCAX4R0015, V1.1.1.1.9c
6:: Siglent Technologies, SSG5060X-V, SSG5XCAX4R0015, V1.1.1.1.9c
7:: Siglent Technologies, SSG5060X-V, SSG5XCAX4R0015, V1.1.1.1.9c
8:: Siglent Technologies, SSG5060X-V, SSG5XCAX4R0015, V1.1.1.1.9c
9:: Siglent Technologies, SSG5060X-V, SSG5XCAX4R0015, V1.1.1.1.9c
Press "Enter" to exit
```



### **About SIGLENT**

SIGLENT is an international high-tech company, concentrating on R&D, sales, production and services of electronic test & measurement instruments.

SIGLENT first began developing digital oscilloscopes independently in 2002. After more than a decade of continuous development, SIGLENT has extended its product line to include digital oscilloscopes, isolated handheld oscilloscopes, function/arbitrary waveform generators, RF/MW signal generators, spectrum analyzers, vector network analyzers, digital multimeters, DC power supplies, electronic loads and other general purpose test instrumentation. Since its first oscilloscope was launched in 2005, SIGLENT has become the fastest growing manufacturer of digital oscilloscopes. We firmly believe that today SIGLENT is the best value in electronic test & measurement.

### **Headquarters:**

SIGLENT Technologies Co., Ltd  
Add: Bldg No.4 & No.5, Antongda Industrial  
Zone, 3rd Liuxian Road, Bao'an District,  
Shenzhen, 518101, China  
Tel: + 86 755 3688 7876  
Fax: + 86 755 3359 1582  
Email: sales@siglent.com  
Website: int.siglent.com

### **North America:**

SIGLENT Technologies America, Inc  
6557 Cochran Rd Solon, Ohio 44139  
Tel: 440-398-5800  
Toll Free: 877-515-5551  
Fax: 440-399-1211  
Email: info@siglentna.com  
Website: www.siglentna.com

### **Europe:**

SIGLENT Technologies Germany GmbH  
Add: Staetzlinger Str. 70  
86165 Augsburg, Germany  
Tel: +49(0)-821-666 0 111 0  
Fax: +49(0)-821-666 0 111 22  
Email: info-eu@siglent.com  
Website: www.siglenteu.com

Follow us on  
Facebook: SiglentTech

