

SDS1000X-E SDS1000X-U Digital Oscilloscope

User Manual

EN05B
Aug.2021



Copyright and Declaration

Copyright

SIGLENT TECHNOLOGIES CO., LTD. All Rights Reserved.

Trademark Information

SIGLENT is the registered trademark of **SIGLENT TECHNOLOGIES CO., LTD.**

Declaration

SIGLENT products are protected by patent law in and outside of P.R.C.

SIGLENT reserves the right to modify or change parts of or all the specifications or pricing policies at company's sole decision.

Information in this publication replaces all previously corresponding material.

Any way of copying, extracting or translating the contents of this manual is not allowed without the permission of **SIGLENT**.

Product Certification

SIGLENT guarantees this product conforms to the national and industrial stands in China and other international stands conformance certification is in progress.

Contact Us

If you have any problem or requirement when using our products, please contact **SIGLENT TECHNOLOGIES CO., LTD**

Add: Blog No.4 & No.5, Antongda Industrial Zone, 3rd Liuxian Road, Bao'an District, Shenzhen, 518101, China

Tel: 400-878-0807

E-mail: sales@siglent.com

<http://www.siglent.com>

Introduction

This user manual includes important safety and installation information related to the SDS1000X-E and SDS1000X-U series oscilloscopes, and includes simple tutorials for basic operation of the oscilloscope.

The series includes the following models:

Model	Analog Bandwidth
SDS1204X-E	200 MHz bandwidth, 4-channel, 1 GSa/s Sample rate
SDS1104X-E	100 MHz bandwidth, 4-channel, 1 GSa/s Sample rate
SDS1202X-E	200 MHz bandwidth, 2-channel, 1 GSa/s Sample rate
SDS1104X-U	100 MHz bandwidth, 4-channel, 1 GSa/s Sample rate

General Safety Summary

Carefully read the following safety precautions to avoid any personal injury or damage to the instrument and any products connected to it. To avoid potential hazards, please use the instrument as specified.

Use Proper Power Line

Only the power cord designed for the instrument and authorized by local country could be used.

Ground the Instrument

The instrument is grounded through the protective earth conductor of the power line. To avoid electric shock, please make sure the instrument is grounded correctly before connecting its input or output terminals.

Connect the Signal Wire Correctly

The potential of the signal wire is equal to the earth, so do not connect the signal wire to a high voltage.

Look Over All Terminals' Ratings

To avoid fire or electric shock, please look over all ratings and sign instruction of the instrument. Before connecting the instrument, please read the manual carefully to gain more information about the ratings.

Use Proper Overvoltage Protection

Make sure that no overvoltage (such as that caused by a thunderstorm) can reach the product, or else the operator might expose to danger of electrical shock.

Electrostatic Prevention

Operate in an electrostatic discharge protective area environment to avoid damages induced by static discharge. Always ground both the internal and external conductors of the cable to release static before connecting.

Keep Well Ventilation

Inadequate ventilation may cause increasing of temperature, which will eventually damage the instrument. So keep well ventilation and inspect the intake and fan regularly.

Avoid Circuit or Components Exposed

Do not touch exposed contacts or components when the power is on.

Use proper Fuse

Use only the specified fuse.

Do Not Operate Without Covers

Do not operate the instrument with covers or panels removed.

Do Not Operate With Suspected Failures.

If you suspect damage occurs to the instrument, have it inspected by qualified service personnel before further operations. Any maintenance, adjustment or replacement especially to circuits or accessories must be performed by **SIGLENT** authorized personnel.

Do Not Operate in Wet Conditions.

In order to avoid short circuiting to the interior of the device or electric shock, please do not operate in a humid environment.

Do Not Operate in an Explosive Atmosphere.

In order to avoid damages to the device or personal injuries, it is important to operate the device away from an explosive atmosphere.

Keep Product Surfaces Clean and Dry.

To avoid the influence of dust and/or moisture in air, please keep the surface of device clean and dry.

Handling Safety

Please handle with care during transportation to avoid damages to buttons, knob interfaces and other parts on the panels.

Only probe assemblies which meet the manufacturer's specifications shall be used.

When use 2X/.../10000X probe assemblies, the probe assemblies shall be insulated from the measured circuits by double or reinforced insulation.

All probe assemblies should meet the requirements of UL 61010-031 and CAN/CSA-C22.2 No. 61010-031-07.

Not to position the equipment so that it is difficult to operate the disconnecting device (detachable plug).

If the equipment is used in a manner not specified by the manufacturer, the protection provided by the equipment may be impaired

Safety Terms and Symbols

Terms in this Manual. These terms may appear in this manual:



WARNING

Warning statements indicate the conditions or practices that could result in injury or loss of life.



CAUTION

Caution statements indicate the conditions or practices that could result in damage to this product or other property.

Terms on the product. These terms may appear on the product:

DANGER Indicates direct injuries or hazards that may happen.

WARNING Indicates potential injuries or hazards that may happen.

CAUTION Indicates potential damages to the instrument or other property that may happen.

Symbols on the product. These symbols may appear on the product:



Hazardous
Voltage



protective Earth
Terminal



Warning



Test
Ground



Power Switch

If find such symbols on the product, consult the manual to find out the nature of the potential hazard and the actions which have to be taken

Measurement Category

Measurement Categories

This oscilloscope can make measurements in other circuits that are not directly connected to mains.



WARNING

This oscilloscope can only be used for measurements within its specified measurement categories. Not to use the product for measurements within other measurement categories, such as CAT II, CAT III, CAT IV.

Not to use the equipment for measurements on mains circuits

Measurement Category Definitions

Measurement category II is for measurements performed on circuits directly connected to the low voltage installation. Examples are measurements on household appliances, portable tools and similar equipment.

Measurement category III is for measurements performed in the building installation. Examples are measurements on distribution boards, circuit-breakers, wiring, including cables, bus-bars, junction boxes, switches, socket-outlets in the fixed installation, and equipment for industrial use and some other equipment, for example. Stationary motors with permanent connection to the fixed installation.

Measurement category IV is for measurements performed at the source of the low-voltage installation. Examples are electricity meters and measurements on primary over current protection devices and ripple control units.

Working Environment

Environment

This instrument is intended for indoor use and should be operated in a clean, dry environment.

Temperature

Operating: 0°C to +40°C

Non-operation: -20°C to +60°C

Note: Direct sunlight, radiators, and other heat sources should be taken into account when assessing the ambient temperature.

Humidity

Operating: 85% RH, 40 °C, 24 hours

Non-operating: 85% RH, 65 °C, 24 hours

Altitude

Operating: less than 3 Km

Non-operation: less than 15 Km

Installation (overvoltage) Category

This product is powered by mains conforming to installation (overvoltage) category II.



WARNING

Make sure that no overvoltage (such as that caused by thunderbolt) can reach the product, or else the operator might expose to danger of electric shock.

Installation (overvoltage) Category Definitions

Installation (overvoltage) category I refers to signal level which is applicable to equipment measurement terminals connected to the source circuit. In these terminals, precautions are done to limit the transient voltage to the corresponding low level.

Installation (overvoltage) category II refers to the local power distribution level which is applicable to equipment connected to the AC line (AC power).

Degree of Pollution

The oscilloscopes may be operated in environments of Pollution Degree II.

Note: Degree of Pollution II refers to a working environment which is dry and non-conductive pollution occurs. Occasional temporary conductivity caused by condensation is expected.

IP Rating

IP20 (as defined in IEC 60529).

Ventilation Requirement

This oscilloscope uses fan to force cooling. Please make sure that the air intake and exhaust areas are free from obstructions and have free air. When using the oscilloscope in a bench-top or rack setting, provide at least 10 cm clearance beside, above and behind the instrument for adequate ventilation.



WARNING

Inadequate ventilation may cause temperature increase which would damage the instrument. So please keep the instrument well ventilated during operation and inspect the intake and fan regularly.

AC Power and Ground Connections

The instrument operates with a single-phase, 100 to 240 Vrms (+/-10%) AC power at 50/60 Hz (+/-5%), or single-phase 100 - 120 Vrms (+/-10%) AC power at 400Hz (+/-5%).

No manual voltage selection is required because the instrument automatically adapts to line voltage.

Depending on the type and number of options and accessories (probes, PC port plug-in, etc.), the SDS1xx2X-E can consume up to 25 W of power, the SDS1xx4X-E can consume up to 25 W of power, the SDS1xx4X-U can consume up to 50 W of power.

Note: The instrument automatically adapts to the AC line input within the following ranges:

Voltage Range:	90 - 264 Vrms	90 - 132 Vrms
Frequency Range:	47 - 63 Hz	380 - 420 Hz

The instrument includes a grounded cord set containing a molded three-terminal

polarized plug and a standard IEC320 (Type C13) connector for making line voltage and safety ground connection. The AC inlet ground terminal is connected directly to the frame of the instrument. For adequate protection against electrical shock hazard, the power cord plug must be inserted into a mating AC outlet containing a safety ground contact. Use only the power cord specified for this instrument and certified for the country of use.



WARNING

Electrical Shock Hazard!

Any interruption of the protective ground conductor within or outside of the scope or disconnection of the safety ground terminal creates a hazardous situation.

Intentional interruption is prohibited.

The position of the oscilloscope should allow easy access to the socket. To make the oscilloscope completely power off, unplug the instrument power cord from the AC socket.

The power cord should be unplugged from the AC outlet if the scope is not to be used for an extended period of time.



CAUTION

The outer shells of the front panel terminals (CH1, CH2, CH3, CH4, EXT) are connected to the instrument's chassis and therefore to the safety ground.

General Care and Cleaning

Care

Do not store or leave the instrument in direct sunshine for long periods of time.



WARNING

To avoid damages to the instrument or probe, please do not leave them in fog, liquid, or solvent.

Cleaning

Please perform the following steps to clean the instrument and probe regularly according

to its operating conditions.

Disconnect the instrument from all power sources, and then clean it with a soft wet cloth. Clean the loose dust on the outside of the instrument and probe with a soft cloth. When cleaning the LCD, take care to avoid scarifying it.



WARNING

To avoid damages to the surface of the instrument and probe, please do not use any corrosive liquid or chemical cleanser.



WARNING

Make sure that the instrument is completely dry before restarting it to avoid short circuits or personal injuries.

Safety Compliance

This section lists the safety standards with which the product complies.

U.S. nationally recognized testing laboratory listing

- UL 61010-1:2012/R:2018-11. Safety Requirements for Electrical Equipment for Measurement, Control, and Laboratory Use - Part 1: General Requirements.
- UL 61010-2-030:2018. Safety Requirements for Electrical Equipment for Measurement, Control, and Laboratory Use - Part2-030: Particular requirements for testing and measuring circuits.

Canadian certification

- CAN/CSA-C22.2 No. 61010-1:2012/A1:2018-11. Safety Requirements for Electrical Equipment for Measurement, Control, and Laboratory Use - Part 1: General Requirements.
- CAN/CSA-C22.2 No. 61010-2-030:2018. Safety Requirements for Electrical Equipment for Measurement, Control, and Laboratory Use - Part 2-030: Particular requirements for testing and measuring circuits.

Résumé général de sûreté

Lisez soigneusement les mesures de sécurité suivantes pour éviter n'importe quelles blessures ou les dommages à l'instrument et à tous les produits se sont reliés à eux. Pour éviter des risques, utilisez svp l'instrument comme indiqué.

Employez la ligne à haute tension appropriée

Seulement le cordon de secteur conçu pour l'instrument et autorisé par le pays local a pu être employé.

A rectifié l'instrument.

L'instrument est fondu par le conducteur protecteur de terra de la ligne à haute tension. Pour éviter la décharge électrique, le conducteur moulu doit être relié à la terre. Assurez-vous que l'instrument est fondu correctement avant de relier ses bornes d'entrée ou de rendement.

Reliez le fil de signal correctement.

Le potentiel de l'au sol de fil de signal est égal à la terre, ainsi ne relie pas le fil de signal à une tension.

Regardez estimations au-dessus de toutes les bornes des'

Pour éviter le feu ou la décharge électrique, regardez svp au-dessus de toutes les estimations et instruction de signe de l'instrument. Avant de relier l'instrument, lisez svp le manuel soigneusement pour obtenir plus d'informations sur les estimations.

Employez la protection appropriée de surtension

Assurez-vous qu'aucune surtension (comme cela provoqué par un orage) ne peut atteindre le produit, ou bien l'opérateur pourrait exposer au danger du choc électrique.

Empêchement électrostatique

Fonctionnez dans un environnement protecteur de secteur de décharge électrostatique pour éviter des dommages induits par décharge statique. A toujours rectifié les conducteurs internes et externes du câble pour libérer la charge statique avant de se relier.

La ventilation insatisfaisante de ventilation

bonne de subsistance peut causer l'augmentation de la température, qui endommagera par la suite l'instrument. Gardez ainsi la ventilation bonne et inspectez la prise et éventez régulièrement.

Évitez le circuit ou les composants exposés

ne touchent pas les contacts ou les composants exposés quand le courant passe.

Employez l'utilisation appropriée

de fusible seulement le fusible indiqué.

Ne fonctionnez pas sans couvertures

n'actionnent pas l'instrument des couvertures ou des panneaux étant coupés.

Ne fonctionnez pas avec des échecs suspectés.

Si vous suspectez les dommages se produisent à l'instrument, l'ont inspecté par le personnel de service qualifié avant d'autres opérations. N'importe quel entretien, ajustement ou remplacement particulièrement aux circuits ou aux accessoires doivent être exécutés par le personnel autorisé par **SIGLENT**.

Ne fonctionnez pas en conditions humides.

Afin d'éviter de court-circuiter à l'intérieur du dispositif ou de la décharge électrique, svp ne fonctionnez pas dans un environnement humide.

Do Not Operate in an Explosive Atmosphere.

Ne fonctionnez pas dans une atmosphère explosive.

Afin d'éviter d'endommager le dispositif ou les blessures, il est important d'utiliser le dispositif loin à partir d'une atmosphère explosive.

Maintenez les surfaces de produit propres et sèches.

Pour éviter l'influence de la poussière et/ou de l'humidité en air, maintenez svp la surface du dispositif propre et sèche.

En manipulant la sûreté

manipulez svp avec soin pendant le transport pour éviter d'endommager des boutons, des interfaces de bouton et d'autres parties sur les panneaux.

Sondez seulement les ensembles qui répondent aux caractéristiques du fabricant seront employés.

Quand des sondes de l'utilisation 5X/10X/50X/100X/500X/1000X, les sondes seront isolées des circuits mesurés par le double ou l'isolation renforcée.

Toutes les sondes devraient répondre aux exigences de l'UL 61010-031 et du CAN/CS A-C22.2 No. 61010-031-07

Le corps ou l'opérateur responsable devrait se référer au manuel d'instruction pour préserver la protection se permettent par l'équipement. Si l'équipement est utilisé en quelque sorte non indiqué par le fabricant, la protection fournie par l'équipement peut être altérée.

On ne permet à aucune pièce du dispositif et de ses accessoires d'être changé ou remplacé, autre qu'autorisé par le fabricant ou son agent.

Pas placez l'équipement de sorte qu'il soit difficile d'utiliser le dispositif débranchant (prise détachable).

Limites et symboles de sûreté

Limites en ce manuel. Ces limites peuvent apparaître en ce manuel :



Les rapports

d'avertissement D'AVERTISSEMENT indiquent les conditions ou les pratiques qui pourraient avoir comme conséquence les dommages ou la perte de la vie.



Les rapports

d'attention d'ATTENTION indiquent les conditions ou les pratiques qui pourraient avoir comme conséquence les dommages à ce produit ou à toute autre propriété.

Limites sur le produit. Ces limites peuvent apparaître sur le produit :

Le DANGER indique les dommages ou les risques directs qui peuvent se produire.
Dommages ou risques potentiels de WARNING indiquent qui peuvent se produire.
L'ATTENTION indique des dommages potentiels à l'instrument ou à toute autre propriété qui peuvent se produire.

Si la trouvaille de tels symboles sur le produit, consultez le manuel pour découvrir la nature du risque et des actions qui doivent être pris.

Symboles sur le produit. Ces symboles peuvent apparaître sur le produit :



Dangereux
Tension



Protecteur
Au sol de la terre



Avertissement



Châssis
Ground



Puissance
Switch

Catégorie de mesure

Les oscilloscopes peuvent faire des mesures dans d'autres circuits qui ne sont pas directement reliés aux forces. Pour ne pas employer le produit pour des mesures dans d'autres catégories de mesure, telles que le CAT II, CAT III, CAT IV.

Ne pas utiliser l'équipement pour des mesures sur des forces circuite, pour ne pas utiliser l'équipement pour des mesures sur la tension excèdent la gamme de tension décrivent dans le manuel.



cet oscilloscope peut seulement être employé pour des mesures dans ses catégories indiquées de mesure.

La catégorie II de mesure

de définitions de catégorie de mesure est pour des mesures effectuées sur des circuits directement reliés à l'installation de basse tension. Les exemples sont des mesures sur des appareils électroménagers, des outils portatifs et l'équipement semblable.

La catégorie III de mesure est pour des mesures effectuées dans l'installation de bâtiment. Les exemples sont des mesures sur des conseils de distribution, des disjoncteurs, le câblage, y compris des câbles, des barres omnibus, des boîtes de jonction, des commutateurs, des douille-sorties dans l'installation fixe, et l'équipement à l'utilisation industrielle et à un autre équipement,

par exemple. Moteurs stationnaires avec le raccordement permanent à l'installation fixe.

La catégorie IV de mesure est pour des mesures effectuées à la source d'installation de basse tension. Les exemples sont des mètres et des mesures de l'électricité sur les dispositifs de protection d'excédent primaire et les unités de commande courants d'ondulation.

Environnement de fonctionnement

Environnement

Cet instrument est utilisé à l'intérieur des locaux et doit être utilisé dans un environnement propre et sec.

Température ambiante

En fonctionnement: 0 °C à +40 °C

Hors fonctionnement: -20 °C à +60 °C

Note: pour évaluer la température de l'environnement, il convient de tenir compte des rayonnements solaires directs, des radiateurs thermiques et d'autres sources de chaleur.

Humidité

Fonctionnement: 85% HR, 40 °C, 24 heures

Hors fonctionnement: 85% HR, 65 °C, 24 heures



EN AVERTISSANT

d'éviter le court-circuit à l'intérieur de l'instrument ou de la décharge électrique, svp ne fonctionnez pas dans l'environnement humide.

Altitude

d'altitude : moins de 3 kilomètres

de non-fonctionnement : moins de 15 kilomètres

Catégorie d'installation (surtension)

Ce produit est alimenté par une alimentation électrique conforme à l'installation (surtension) Catégorie II.



EN AVERTISSANT

assurez-vous qu'aucune surtension (comme cela provoqué par coup de foudre) ne peut atteindre le produit, ou bien l'opérateur pourrait exposer au danger de la décharge électrique.

Installation (overvoltage) Category Definitions Définition de catégorie d'installation (surtension)

La catégorie II d'installation (surtension) est un niveau de signal applicable aux terminaux de mesure d'équipement reliés au circuit source. Dans ces bornes, des mesures

préventives sont prises pour limiter la tension transitoire à un niveau inférieur correspondant.

La catégorie II d'installation (surtension) désigne le niveau local de distribution d'énergie d'un équipement conçu pour accéder à un circuit alternatif (alimentation alternative).

Degré de pollution

Un oscilloscope peut être utilisé dans un environnement Pollution Degree II.

Note: Pollution Degree II signifie que le milieu de travail est sec et qu'il y a une pollution non conductrice. Parfois, la condensation produit une conductivité temporaire.

IP Rating

IP20 (as defined in IEC 60529).

Condition de ventilation

This oscilloscope uses fan to force cooling. Please make sure that the air intake and exhaust areas are free from obstructions and have free air. When using the oscilloscope in a bench-top or rack setting, provide at least 10 cm clearance beside, above and behind the instrument for adequate ventilation.

Cet oscilloscope utilise le ventilateur pour forcer le refroidissement. Veuillez s'assurer que les secteurs d'entrée et d'échappement d'air sont exempts des obstructions et ont l'air libre. À l'aide de l'oscilloscope dans un mettre hors jeu-dessus ou un arrangement de support, fournissez au moins le dégagement de 10 centimètres près, au-dessus et derrière de l'instrument pour à ventilation proportionnée.



EN AVERTISSANT

La ventilation insatisfaisante peut causer l'augmentation de la température qui endommagerait l'instrument. Veuillez ainsi la subsistance l'instrument bien aéré lors du fonctionnement et inspectez la prise et éventez régulièrement.

Connexions d'alimentation et de terre

L'instrument fonctionne avec une alimentation CA monophasée de 100 à 240 Vrms (+/- 10%) à 50/60 Hz (+/- 5%) ou monophasée 100-120 Vrms (+/- 10%) Alimentation AC à 400 Hz (+/- 5%).

Aucune sélection manuelle de la tension n'est requise car l'instrument s'adapte automatiquement à la tension de ligne.

Selon le type et le nombre d'options et d'accessoires (sondes, plug-in de port PC, etc.), SDS1xx2X-E peut consommer jusqu'à 25 W d'énergie, SDS1xx4X-E peut consommer jusqu'à 50 W d'énergie, SDS1xx4X-U peut consommer jusqu'à 50 W d'énergie.

Remarque: l'instrument s'adapte automatiquement à l'entrée de ligne CA dans les plages suivantes:

Plage de tension:	90 - 264 Vrms	90 - 132 Vrms
Gamme de fréquences:	47 - 63 Hz	380 - 420 Hz

L'instrument comprend un jeu de cordons mis à la terre contenant une fiche polarisée à trois bornes moulée et un connecteur standard IEC320 (Type C13) pour établir la tension de ligne et la connexion de mise à la terre de sécurité. La borne de mise à la terre de l'entrée CA est directement connectée au châssis de l'instrument. Pour une protection adéquate contre les risques d'électrocution, la fiche du cordon d'alimentation doit être insérée dans une prise secteur correspondante contenant un contact de sécurité avec la terre. Utilisez uniquement le cordon d'alimentation spécifié pour cet instrument et certifié pour le pays d'utilisation.

	<p>EN AVERTISSANT: risque de choc électrique!</p> <p>Toute interruption du conducteur de terre de protection à l'intérieur ou à l'extérieur de la portée ou la déconnexion de la borne de terre de sécurité crée une situation dangereuse.</p> <p>L'interruption intentionnelle est interdite.</p>
---	---

La position de l'oscilloscope doit permettre un accès facile à la prise. Pour éteindre complètement l'oscilloscope, débranchez le cordon d'alimentation de l'instrument de la prise secteur.

Le cordon d'alimentation doit être débranché de la prise secteur si la lunette ne doit pas être utilisée pendant une période prolongée.



EN AVERTISSANT: les enveloppes extérieures des bornes du panneau avant (CH1, CH2, CH3, CH4, EXT) sont connectées au châssis de l'instrument et donc à la terre de sécurité.

Soin général et nettoyage

Ne stockez pas ou ne laissez pas l'instrument en soleil direct pendant de longues périodes.



EN AVERTISSANT

Pour éviter d'endommager l'instrument, svp ne les laissez pas dans le brouillard, le liquide, ou le dissolvant.

nettoyage

Veuillez exécuter les étapes suivantes pour nettoyer l'instrument régulièrement selon ses conditions de fonctionnement.

1. Démontez l'instrument de toutes les sources d'énergie, et puis nettoyez-le avec un tissu humide mou.
2. Nettoyez la poussière lâche sur l'extérieur de l'instrument avec un tissu mou. En nettoyant l'affichage à cristaux liquides, salut pour éviter de le scarifier.



EN AVERTISSANT

Pour éviter d'endommager la surface de l'instrument, svp n'utilisez aucune épierreuse corrosive de liquide ou de produit chimique.



EN AVERTISSANT

Assurez-vous que l'instrument est complètement sec avant de le remettre en marche pour éviter des courts-circuits ou des blessures.

Conformité en matière de sécurité

La présente section présente les normes de sécurité applicables aux produits.

U.S. nationally recognized testing laboratory listing

■ UL 61010-1:2012/R:2018-11. Prescriptions en matière de sécurité pour les appareils électriques utilisés en laboratoire et de mesure - partie 1: prescriptions générales.

■ UL 61010-2-030:2018. Prescriptions de sécurité pour les appareils électriques de mesure, de contrôle et de laboratoire - partie 2 - 030: prescriptions spéciales pour les circuits d'essai et de mesure.

Canadian certification

■ CAN/CSA-C22.2 No. 61010-1:2012/A1:2018-11. Prescriptions en matière de sécurité pour les appareils électriques utilisés en laboratoire et de mesure - partie 1: prescriptions générales.

■ CAN/CSA-C22.2 No. 61010-2-030:2018. Prescriptions de sécurité pour les appareils électriques de mesure, de contrôle et de laboratoire - partie 2 - 030: prescriptions spéciales pour les circuits d'essai et de mesure.

Document Overview

This manual introduces how to use the digital oscilloscope in details.

Quick Start	Provide information about preparations before using the instrument and a brief introduction of the instrument.
Vertical System	Introduce the functions of the vertical system of the oscilloscope.
Horizontal System	Introduce the functions of the horizontal system of the oscilloscope.
Sample System	Introduce the functions of the sample system of the oscilloscope.
Trigger	Introduce the trigger mode, trigger coupling, trigger hold off, external trigger and various trigger types of the oscilloscope.
Serial Trigger and Decode	Introduce the functions of the sample system of the oscilloscope.
Reference Waveform	Introduce how to save and display REF waveform.
Math	Introduce the math operation function of the oscilloscope.
Cursors	Introduce how to use cursors to make measurements.
Measure	Introduce how to use measure function to measure the waveform parameters.
Display	Introduce how to set the display of the oscilloscope.
Save and Recall	Introduce how to save and recall the measurement result and the setting of the oscilloscope.
Digital Channels(Optional)	Introduce the oscilloscope's digital channel
System Setting	Introduce how to set the system setup.
Bode Plot II	Introduce how to set the Bode Plot II.
Search	Introduce the oscilloscope search function
Navigate	Introduce Describe how to use the waveform navigation function of the oscilloscope
History	Introduce how to use and set historical waveform functions.

Table of Content

Copyright and Declaration	I
Introduction	II
General Safety Summary.....	III
Safety Terms and Symbols.....	V
Measurement Category	VI
Working Environment	VII
Ventilation Requirement.....	VIII
AC Power and Ground Connections.....	VIII
General Care and Cleaning	IX
Safety Compliance.....	X
Résumé général de sûreté	XI
Limites et symboles de sûreté	XIII
Catégorie de mesure	XIV
Environnement de fonctionnement.....	XII
Condition de ventilation	XIV
Connexions d'alimentation et de terre	XV
Soin général et nettoyage	XVII
Conformité en matière de sécurité	XVIII
Document Overview.....	XIX
Quick Start	1
General Inspection	2
Appearance and Dimensions.....	3
Prepare for Using	5
Adjust the Supporting Legs	5
Connect the Power Supply	5
Power-on Inspection.....	6
Connect the Probe.....	6
Function Inspection.....	6
Probe Compensation	7
Front Panel Overview	9
Rear Panel Overview	12
Front Panel Function Overview	15
Horizontal.....	15
Vertical	16
Trigger.....	17
Run Control.....	18
Universal Knob	19
Menu	20
Help	22
User Interface.....	23
Security Lock	26
Vertical System	27

Enable the Channel	28
Adjust Scale	29
Vertical Position.....	30
Coupling	30
Bandwidth Limit	31
Probe	31
Unit	32
Deskew	32
Invert	32
Trace Visible/Hidden	33
Label.....	33
Horizontal System.....	35
Horizontal Scale	36
Horizontal Delay.....	37
Roll Mode	38
Zoom Mode.....	39
Sample System	41
Run Control	42
Overview.....	43
Sampling Theory.....	43
Sample Rate	43
Bandwidth and Sample Rate	44
Memory Depth.....	46
Sampling Mode	46
Interpolation Method.....	47
Acquisition Mode.....	50
Normal	50
Peak Detect.....	51
Average	52
Eres	53
Horizontal Format	55
Sequence Mode.....	57
Trigger.....	59
Trigger Source.....	61
Trigger Mode.....	62
Trigger Level	64
Trigger Coupling.....	65
Trigger Holdoff.....	66
Noise Rejection.....	67
Trigger Type	69
Edge Trigger	70
Slope Trigger	72
Pulse Trigger.....	74
Video Trigger	76

Window Trigger	79
Interval Trigger	82
Dropout Trigger	84
Runt Trigger	87
Pattern Trigger	89
Serial Trigger and Decode	91
I2C Trigger and Serial Decode	92
Setup for I2C Signals	92
I2C Trigger	93
I2C Serial Decode	97
SPI Trigger and Serial Decode	99
Setup for SPI Signals	99
SPI Trigger	103
SPI Serial Decode	104
UART Trigger and Serial Decode	106
Setup for UART Signals	106
UART Trigger	108
UART Serial Decode	109
CAN Trigger and Serial Decode	111
Setup for CAN Signals	111
CAN Trigger	112
CAN Serial Decode	114
LIN Trigger and Serial Decode	116
Setup for LIN Signals	116
LIN Trigger	117
LIN Serial Decode	119
Reference Waveform	121
Save REF Waveform to Internal Memory	122
Display REF Waveform	122
Adjust REF Waveform	123
Clear REF Waveform	123
Math	124
Units for Math Waveforms	125
Math Operators	126
Addition or Subtraction	126
Multiplication and Division	127
FFT Operation	128
Math Function Operation	133
Cursors	138
X Cursors	138
Y Cursors	138
Make Cursor Measurements	140
Measure	142
Type of Measurement	143

Voltage Measurements	143
Time Measurements	144
Delay Measurements	145
Add Measurement	147
Clear Measurement	149
All Measurement	150
Gate Measurement	151
Display	152
Display Type	153
Color Display	154
Persistence	155
Clear Display	156
Grid Type	156
Intensity	156
Grid Brightness	157
Transparence	157
Save and Recall	159
Save Type	160
Internal Save and Recall	162
External save and recall	163
Disk Management	166
Create a New File or Folder	167
Delete a File or Folder	168
Rename a File or Folder	168
Digital Channels(Optional)	169
Connect the Digital Probes	170
Acquire Digital Waveform	171
Digital Channels Height	171
Digital Channels Position	172
Single Digital Channel	172
All Digital Channels	173
Logic Threshold	173
Digital Bus	174
Deskew	175
System Setting	176
Remove Device	177
System Setting	178
View System Status	179
Do Self Cal	179
Quick-Cal	181
Sound	181
Language	181
Pass/Fail Test	182
Set and Perform Pass/Fail Test	182

Save and Recall Test Mask.....	183
Arbitrary Waveform Generator(Optional).....	186
Output.....	187
Wave.....	187
Setting.....	189
Systems.....	190
Remove Device.....	192
IO Set.....	193
USB Device.....	193
LAN.....	193
WLAN(Optional).....	194
Web Server.....	196
Set Password.....	196
Web Browser.....	196
Counter.....	199
Data Logger.....	202
Sample Logger.....	202
Measure Logger.....	207
Update Firmware and Configuration.....	212
Do Self-Test.....	213
Screen Test.....	213
Keyboard Test.....	214
LED Test.....	214
Screen Saver.....	216
Date/Time.....	217
Set Date/Time.....	217
Set Time Zone.....	218
Set NTP.....	218
Reference Position.....	220
Power On Line.....	220
Option Management.....	221
Bode Plot II.....	223
Perform Bode Plot.....	223
Setting.....	223
Example.....	227
Simple Sweep Operation.....	227
Vari-level Sweep Operation.....	229
Search.....	232
Setting.....	232
Results.....	233
Navigate.....	235
Time Navigate.....	235
History Frame Navigate.....	235
Search Event Navigate.....	236

History237
Factory Setup.....239
Troubleshooting240

Content of Figure

Figure 1 Front View (2-channel scope) 3

Figure 2 Top View (2-channel scope) 3

Figure 3 Front View (4-channel scope) 4

Figure 4 Top View (4-channel scope) 4

Figure 5 Adjust the Supporting Legs 5

Figure 6 To Connect to Power Supply 6

Figure 7 Function Inspection 7

Figure 8 SDS1000X-E 2-channel Scope Front Panel Overview 9

Figure 9 SDS1000X-E 4-Channel Scope Front Panel Overview 10

Figure 10 SDS1000X-U Scope Front Panel Overview 11

Figure 11 SDS1000X-E 2-Channel Scope Rear panel Overview 12

Figure 12 SDS1000X-E 4-channel Scope Rear panel Overview 13

Figure 13 SDS1000X-U Scope Rear panel Overview 14

Figure 14 Help Message 22

Figure 15 User Interface 23

Figure 16 to Use the Security Lock 26

Figure 17 CH1 Label Display 34

Figure 18 Split Screen Zoom 39

Figure 19 Display Type Set to Dots 48

Figure 20 x Interpolation 48

Figure 21 Sinx/x Interpolation 49

Figure 22 Acquisition System 50

Figure 23 Pulse With 0.1% Duty, Normal Mode 51

Figure 24 Pulse With 0.1% Duty, Peak Detect Mode 52

Figure 25 with Random Noise, Normal Mode 53

Figure 26 with Random Noise, Average Mode 53

Figure 27 SEQUENCE Function Menu 57

Figure 28 HISTORY Function Menu 58

Figure 29 Turn off the Noise Reject 67

Figure 30 Turn on the Noise Reject 68

Figure 31 Edge Trigger 70

Figure 32 Slope Trigger 73

Figure 33 Pulse Trigger 75

Figure 34 Video Trigger 78

Figure 35 Absolute Window Trigger 80

Figure 36 Relative Window Trigger 81

Figure 37 Interval Trigger 83

Figure 38 Edge Dropout Trigger 85

Figure 39 State Dropout Trigger 85

Figure 40 Runt Trigger 88

Figure 41 Pattern Trigger	90
Figure 42 I2C DECODE Menu	92
Figure 43 I2C SIGNAL Menu	92
Figure 44 I2C TRIGGER Menu	95
Figure 45 I2C Decode Bus Display	98
Figure 46 I2C Decode List Display	98
Figure 47 SPI SINGAL Menu	99
Figure 48 SPI CLK Menu	99
Figure 49 MISO Menu	100
Figure 50 MOSI Menu	100
Figure 51 SPI TRIG SET Menu	103
Figure 52 SPI Decode Bus Display	105
Figure 53 SPI Decode List Display	105
Figure 54 UART SIGNAL Menu	106
Figure 55 BUS CONFIG Menu	106
Figure 56 UART TRIG SET Menu	108
Figure 57 UART Trigger	108
Figure 58 UART Decode	109
Figure 59 UART Decode Bus Display	110
Figure 60 UART Decode List Display	110
Figure 61CAN SIGNAL Menu	111
Figure 62 CAN Trigger	113
Figure 63 CAN Decode Bus Display	114
Figure 64 CAN Decode List Display	115
Figure 65 LIN SIGNAL Menu	116
Figure 66 LIN Trigger	118
Figure 67 LIN Decode	119
Figure 68 LIN Decode Bus Display	120
Figure 69 LIN Decode List Display	120
Figure 70 Reference Waveform	123
Figure 71 C1+C2 Waveform	126
Figure 72 C1*C2 Waveform	127
Figure 73 FFT Menu	128
Figure 74 FFT CONFIG Menu	128
Figure 75 VERTICAL Menu	129
Figure 76 HORIZONTAL Menu	130
Figure 77 FFT Peaks Menu	130
Figure 78 SEARCH Menu	130
Figure 79 FFT Markers Menu	131
Figure 80 Marker Control Menu	131
Figure 81 FFT Waveform	132
Figure 82 Difference Function Operation	134
Figure 83 Integral without Offset	135
Figure 84 Integral with Offset	136

Figure 85 Square Root	137
Figure 86 Measure Pulse Width	141
Figure 87 Voltage Measurements	143
Figure 88 Overshoot.....	144
Figure 89 Preshoot.....	144
Figure 90 Time Measurements	145
Figure 91 Select the Measurement Parameter	147
Figure 92 Added the Measurement.....	148
Figure 95 Clear Measurement.....	149
Figure 93 All Parameters Measurement	150
Figure 94 Gate Measurement	151
Figure 96 Vectors Display	153
Figure 97 Dots Display	154
Figure 98 Color Temperature	154
Figure 99 Persist Set to Infinite	155
Figure 100 SAVE/RECALL File System.....	163
Figure 101 Select Save Location	164
Figure 102 File Name Dialogue.....	164
Figure 103 Input Keyboard.....	167
Figure 104 Digital Function Menu	171
Figure 105 Middle Display Type.....	171
Figure 106 High Display Type.....	172
Figure 107 THRESHOLDS Function Menu	173
Figure 108 DIGITALBUS Function Menu.....	174
Figure 109 Digital Bus	175
Figure 110 Digital System Information Interface.....	176
Figure 111 Digital Update Interface	177
Figure 112 System Status	179
Figure 113 Do Self Cal	180
Figure 114 Pass/Fail Test	182
Figure 115 AWG Menu Interface.....	187
Figure 116 Wave Type Interface.....	187
Figure 117 Built-in Arb Interface.....	189
Figure 118 AWG Setting Interface	189
Figure 119 AWG System Information Interface	191
Figure 120 AWG Update Interface.....	192
Figure 121 LAN Setting Interface	194
Figure 122 WIFI Setting Menu	195
Figure 123 Web Server Interface	196
Figure 124 Counter Setting Interface	199
Figure 125 Counter-Gate Setting Interface.....	200
Figure 126 Statistics Function.....	201
Figure 127 Data Logger Interface	202
Figure 128 Sample Logger Interface.....	203

Figure 129 Settings Interface	204
Figure 130 Start Recording Waveform.....	204
Figure 131 View Recorded Waveform	205
Figure 132 Measure Logger Interface.....	207
Figure 133 Settings Interface	208
Figure 134 Start to Record Measurement Data.....	208
Figure 135 Cursors of Measure Logger	210
Figure 136 Save/Recall of Measure Logger	210
Figure 137 Save of Measure Logger.....	211
Figure 138 Screen Test.....	213
Figure 139 Keyboard Test.....	214
Figure 140 LED Test	215
Figure 141 Screen Saver Interface	216
Figure 142 Date/Time Function Interface.....	217
Figure 143 Setting Date/Time	217
Figure 144 Time Zone Setting Interface.....	218
Figure 145 NTP Setting Interface.....	219
Figure 146 OPTION Function Menu	221
Figure 147 LABEL Function Menu	221
Figure 148 Option Information.....	222
Figure 149 BODE PLOT II Menu.....	223
Figure 150 CONFIGURE Menu.....	223
Figure 151 VARI-LEVEL Menu	224
Figure 152 DISPLAY Menu	225
Figure 153 DATA Menu.....	226
Figure 154 Bode Plot List On	226
Figure 155 Bode Plot Interface Connection	227
Figure 156 Sweep Configure Menu	227
Figure 157 Set Sweep Parameters Menu	227
Figure 158 Set Stimulus Menu	228
Figure 159 Set Channel Menu	228
Figure 160 Bode Plot Sweep Curve.....	228
Figure 161 Bode Plot Interface Connection	229
Figure 162 Vari-level Configure Menu	229
Figure 163 Set Vari-level Parameters Menu.....	230
Figure 164 Set Sweep Parameters Menu	230
Figure 165 Bode Plot Sweep Curve.....	231
Figure 166 Search Menu	232
Figure 167 Search in Run	234
Figure 168 Search in Stop.....	234
Figure 169 History	237

Quick Start

This chapter introduces the preparations when using the oscilloscope for the first time, the front panel, rear panel and user interface of the oscilloscope.

The contents of this chapter:

- ◆ General Inspection
- ◆ Appearance and Dimensions
- ◆ Prepare for Using
- ◆ Front Panel Overview
- ◆ Rear Panel Overview
- ◆ Front Panel Function Overview
- ◆ Help
- ◆ User Interface
- ◆ Security Lock

General Inspection

1. Inspect the shipping container for damage.

Keep the damaged shipping container or cushioning material until the contents of the shipment have been checked for completeness and the instrument has passed both electrical and mechanical tests.

The consigner or carrier shall be liable for the damage to instrument resulting from shipment. **SIGLENT** would not be responsible for free maintenance/rework or replacement of the unit.

2. Inspect the instrument.

In case of any damage, or defect, or failure, notify your **SIGLENT** sales representative.

3. Check the Accessories

Please check the accessories according to the packing lists. If the accessories are incomplete or damaged, please contact your **SIGLENT** sales representative.

Appearance and Dimensions

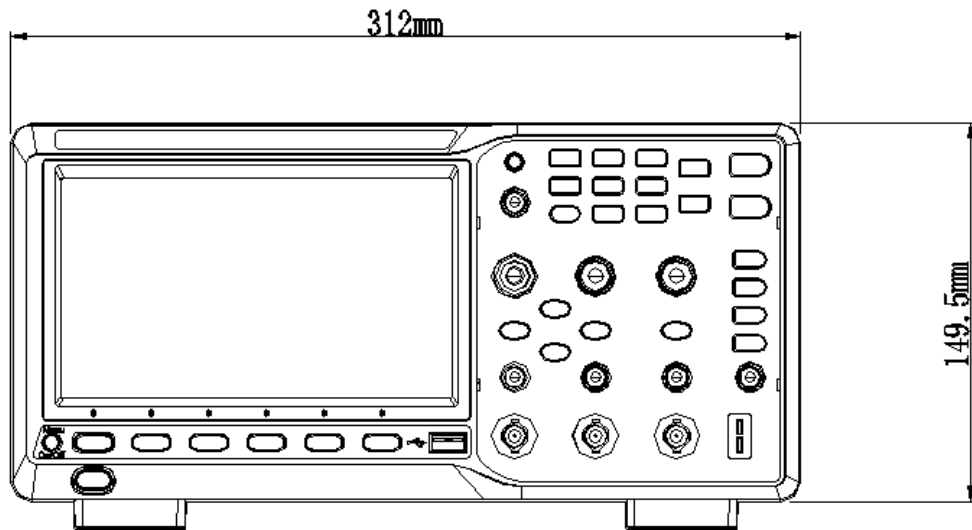

Figure 1 Front View (2-channel scope)

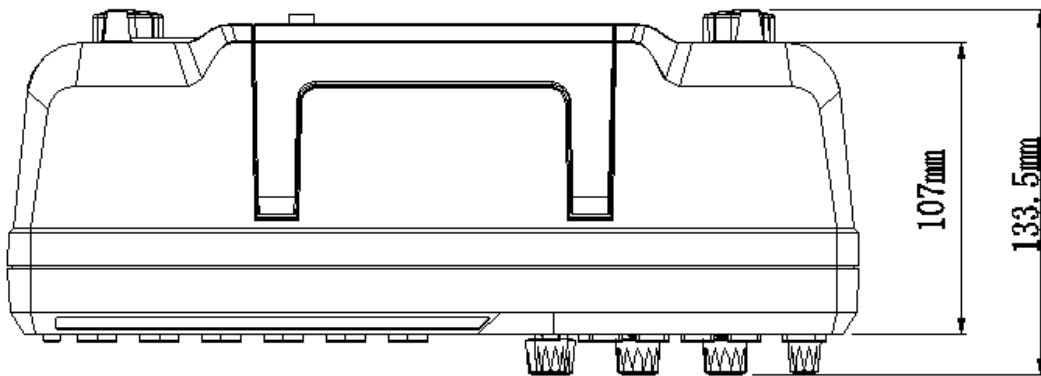

Figure 2 Top View (2-channel scope)

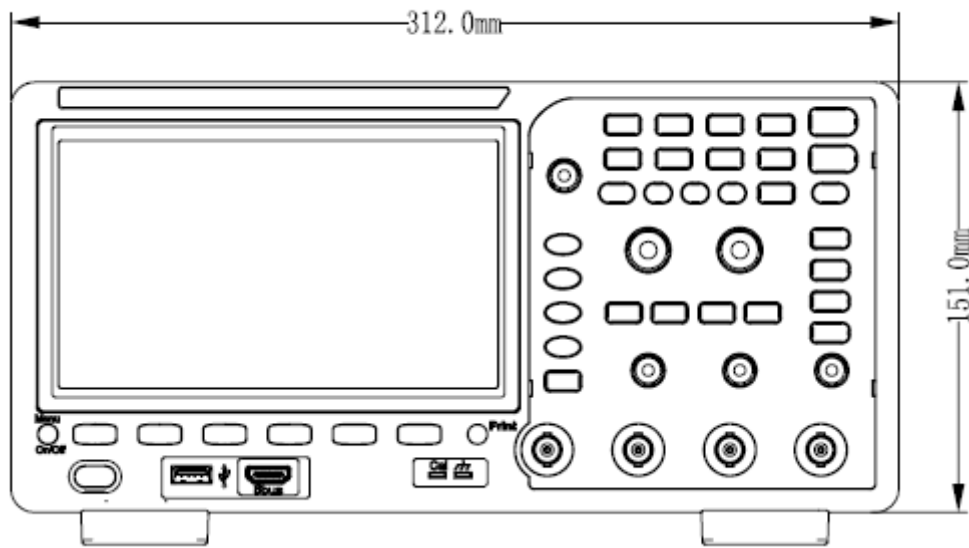

Figure 3 Front View (4-channel scope)

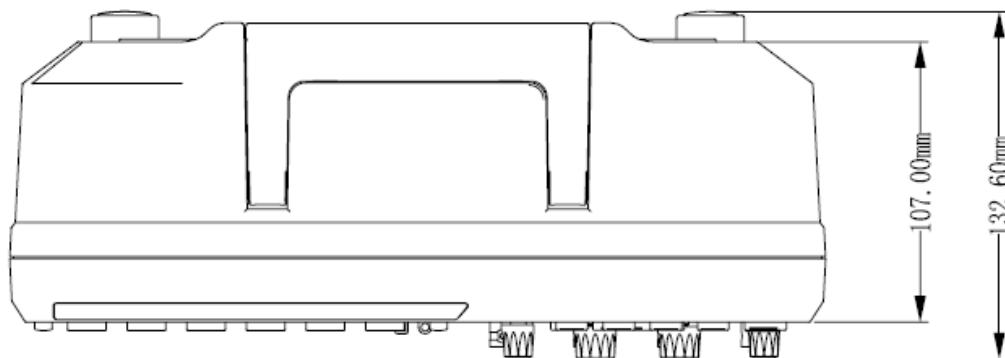

Figure 4 Top View (4-channel scope)

Prepare for Using

Adjust the Supporting Legs

Adjust the supporting legs properly to use them as stands to tilt the oscilloscope upwards for stable placement of the oscilloscope as well as better operation and observation.

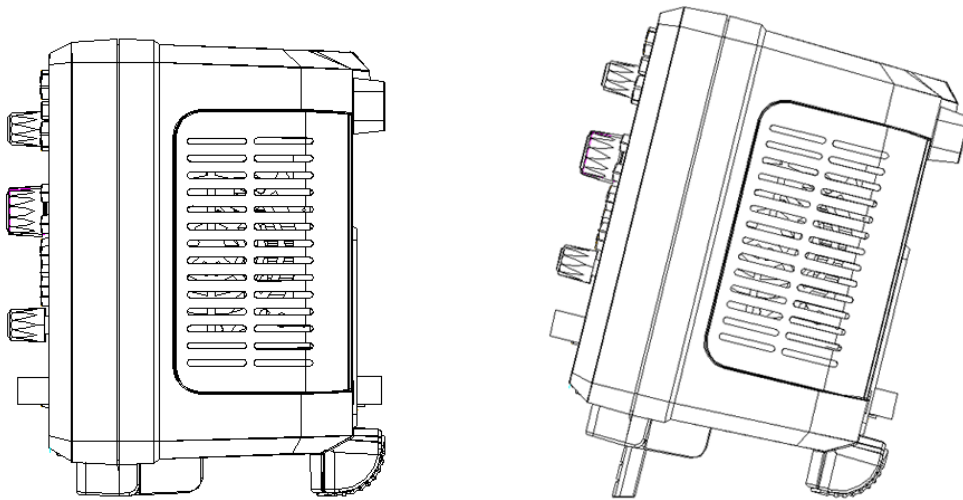

Figure 5 Adjust the Supporting Legs

Connect the Power Supply

The power requirements of the oscilloscope are 100-240 V, 50/60Hz or 100-120 V, 400Hz. Please use the power cord supplied with the accessories to connect the oscilloscope to the power source.

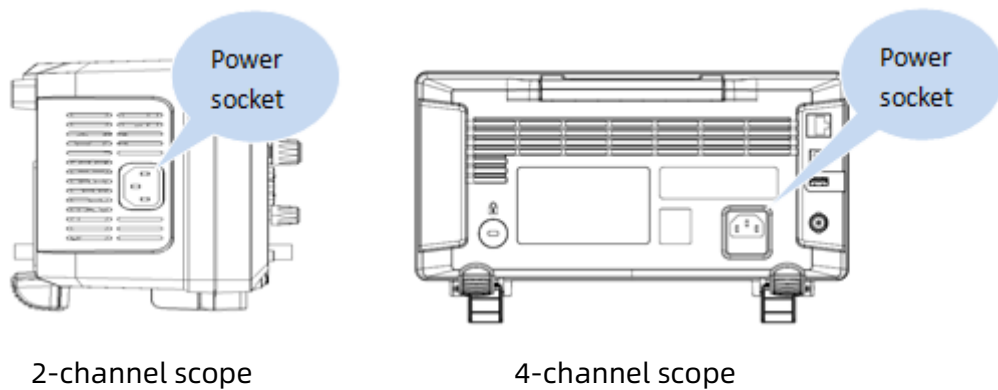

Figure 6 To Connect to Power Supply

Power-on Inspection

When the oscilloscope is energized, press the power key at the lower-left corner of the front panel to start the oscilloscope. During the start-up process, the oscilloscope performs a series of self-tests and you can hear the sound of relay switching. After the self-test is finished, the welcome screen is displayed.

Connect the Probe

Connect the Probe:

1. Connect the BNC terminal of the probe to a channel BNC connector of the oscilloscope at the front panel.
2. Connect the probe tip to the circuit point to be tested and connect the ground alligator clip of the probe to the circuit ground terminal.

Function Inspection

1. Press the **Default** button on the front panel to restore the instrument to its default configuration.
2. Connect the ground alligator clip of the probe to the “Ground Terminal” under the probe compensation signal output terminal.

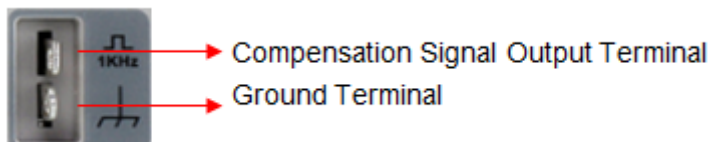

2-channel scope

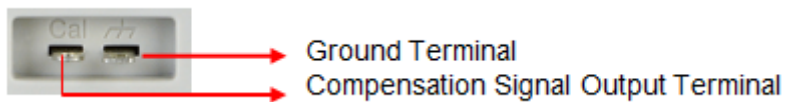

4-channel scope

3. Use the probe to connect the input terminal of CH1 of the oscilloscope and the “Compensation Signal Output Terminal” of the probe.
4. Press the **Auto Setup**.
5. Observe the waveform on the display. In normal condition, the display should be a square waveform as shown in the figure below:

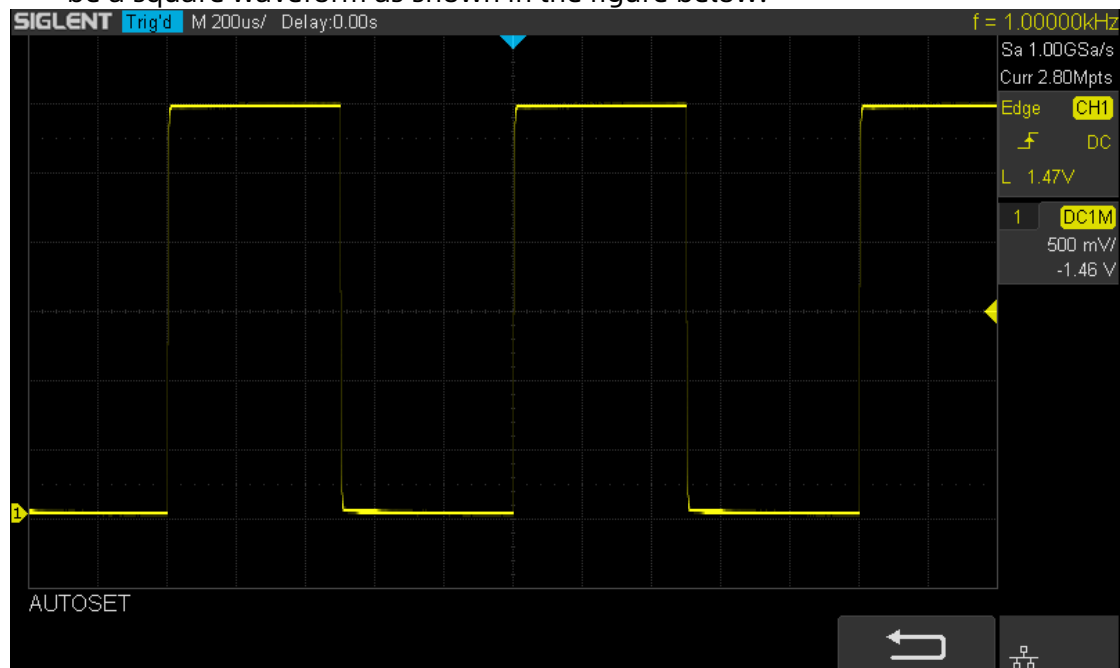

Figure 7 Function Inspection

6. Use the same method to test the other channels. If the square waveforms actually shown do not match that in the figure above, please perform “Probe Compensation” in the next section.

WARNING



To avoid electric shock during the use of probe, please make sure that the insulated wire of the probe is in good condition and do not touch the metallic part of the probe when the probe is connected to high voltage source

Probe Compensation

When the probes are used for the first time, you should compensate the probes to match the input channels of the oscilloscope. Non-compensated or poorly

compensated probes may cause measurement inaccuracy or error. The probe compensation procedures are as follows.

1. Set the switch to 10X on the probe.
2. Perform steps 1, 2, 3 and 4 of “Function Inspection” in the previous section.
3. Check the waveforms displayed and compare them with the following:

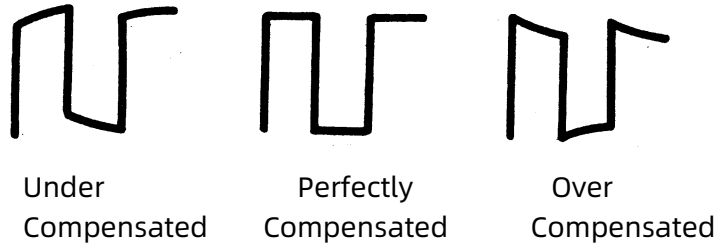

4. Use a nonmetallic driver to adjust the low-frequency compensation adjustment hole on the probe until the waveform displayed is as the “Perfectly compensated” in the figure above.

Front Panel Overview

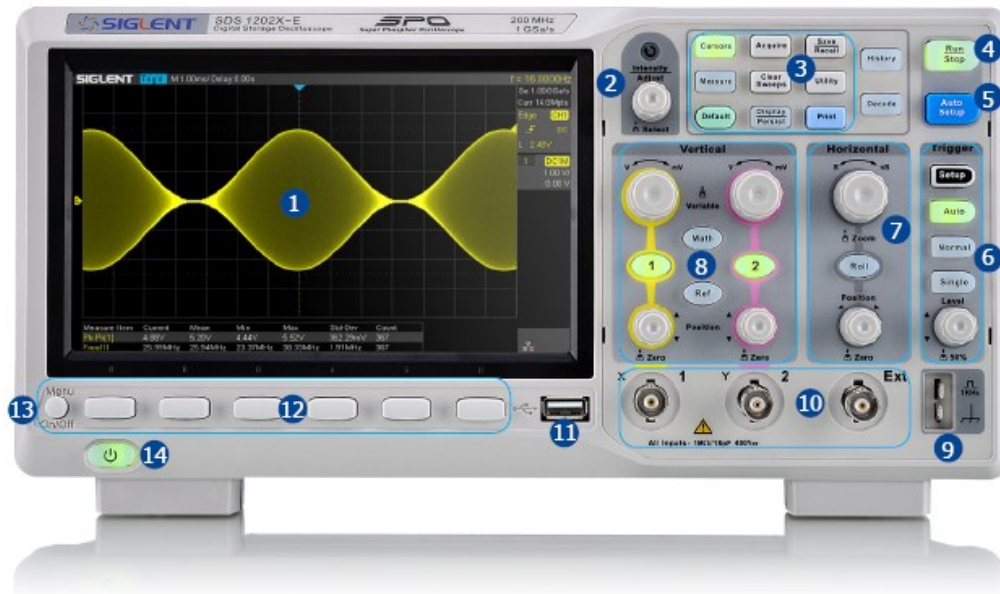

Figure 8 SDS1000X-E 2-channel Scope Front Panel Overview

NO.	Description	NO.	Description
1	LCD Display	8	Vertical Control
2	Universal Knob	9	Probe Compensation/ Ground Terminal
3	Common Function Menus	10	Analog Channel and Ext Input
4	Run/Stop	11	USB Host
5	Auto Setup	12	Menu Soft key
6	Trigger Control	13	Menu on/off
7	Horizontal Control	14	Power Button

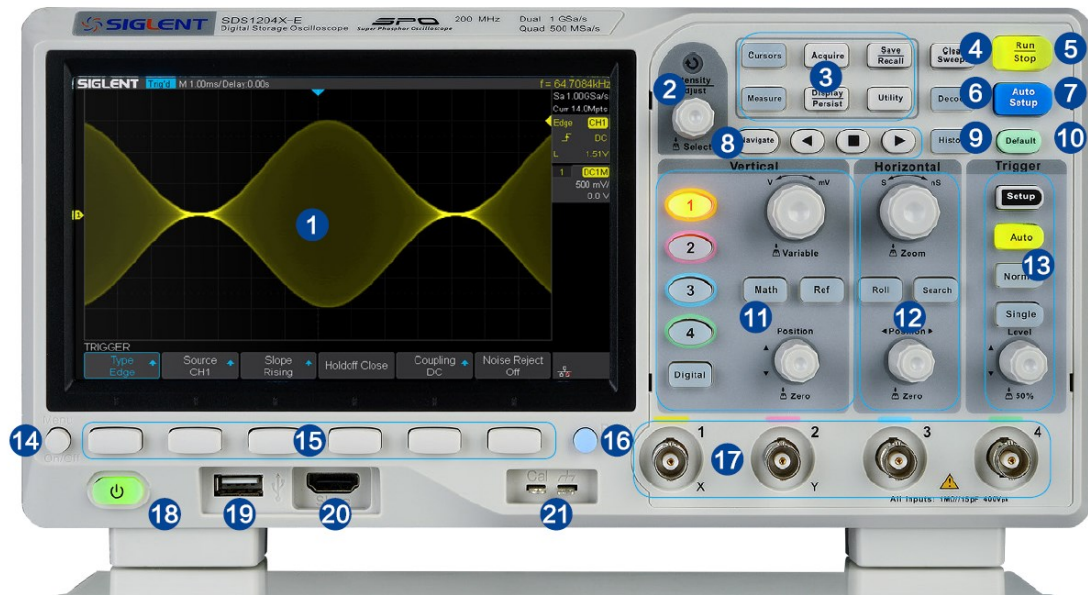

Figure 9 SDS1000X-E 4-Channel Scope Front Panel Overview

NO.	Description	NO.	Description
1	LCD Display	12	Horizontal Control
2	Universal Knob	13	Trigger Control
3	Common Function Menus	14	Menu on/off
4	Clear Sweeps	15	Menu Soft key
5	Run/Stop	16	One- Button shortcut for Save
6	Decode	17	Analog Channel
7	Auto Setup	18	Power Button
8	Navigate	19	USB Host
9	History	20	Digital Inputs
10	Default	21	Probe Compensation/ Ground Terminal
11	Vertical Control, Math, REF and Digital		

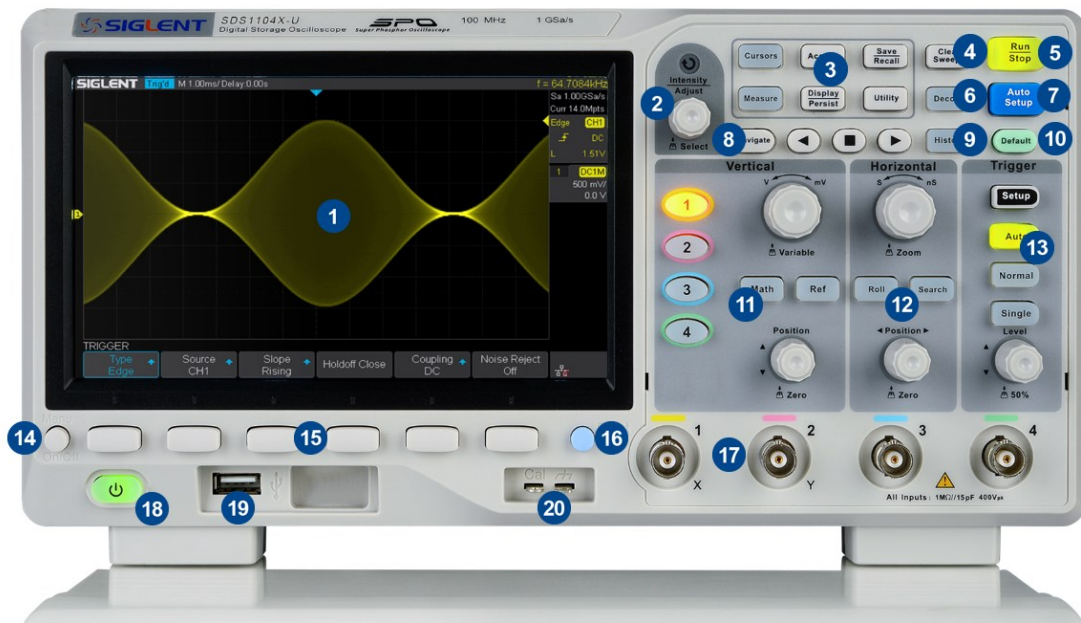

Figure 10 SDS1000X-U Scope Front Panel Overview

NO.	Description	NO.	Description
1	LCD Display	12	Horizontal Control
2	Universal Knob	13	Trigger Control
3	Common Function Menus	14	Menu on/off
4	Clear Sweeps	15	Menu Soft key
5	Run/Stop	16	One- Button shortcut for Save
6	Decode	17	Analog Channel
7	Auto Setup	18	Power Button
8	Navigate	19	USB Host
9	History	20	Probe Compensation/ Ground Terminal
10	Default		
11	Vertical Control, Math, REF		

Rear Panel Overview

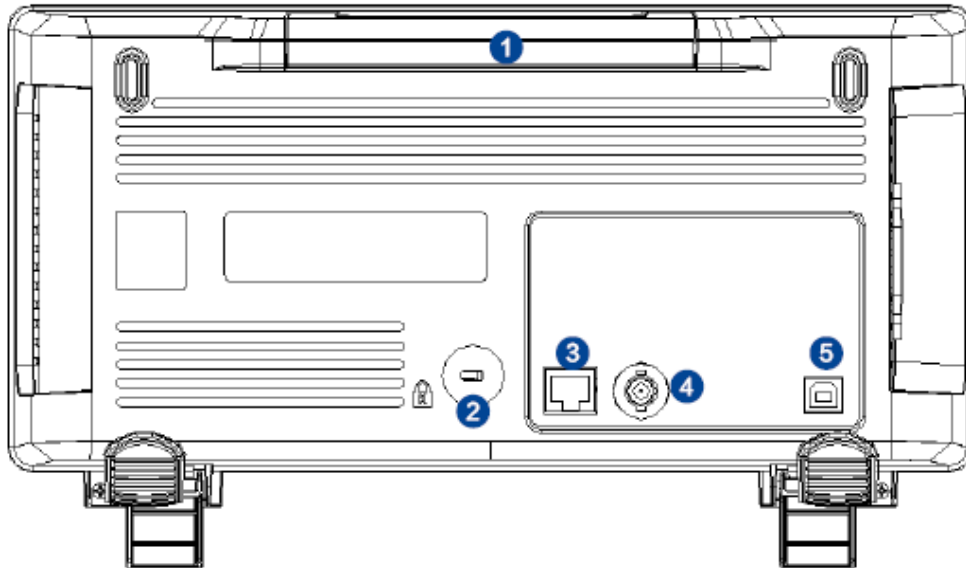

Figure 11 SDS1000X-E 2-Channel Scope Rear panel Overview

1. **Handle**
Pull up the handle vertically for easy carrying of the instrument. When you do not need the handle, press it down.
2. **Safety lock Hole**
You can lock the instrument to a fixed location using the security lock (please buy it yourself) via the lock hole.
3. **LAN**
The instrument can be connected to network via this interface to perform remote control.
4. **Pass/Fail or Trigger Out**
The BNC port can output a signal that reflects the current waveform capture rate of the oscilloscope at each trigger or a pass/fail test pulse.
5. **USB Device**
The oscilloscope support SCPI remote control commands, user can control the oscilloscope through this interface.

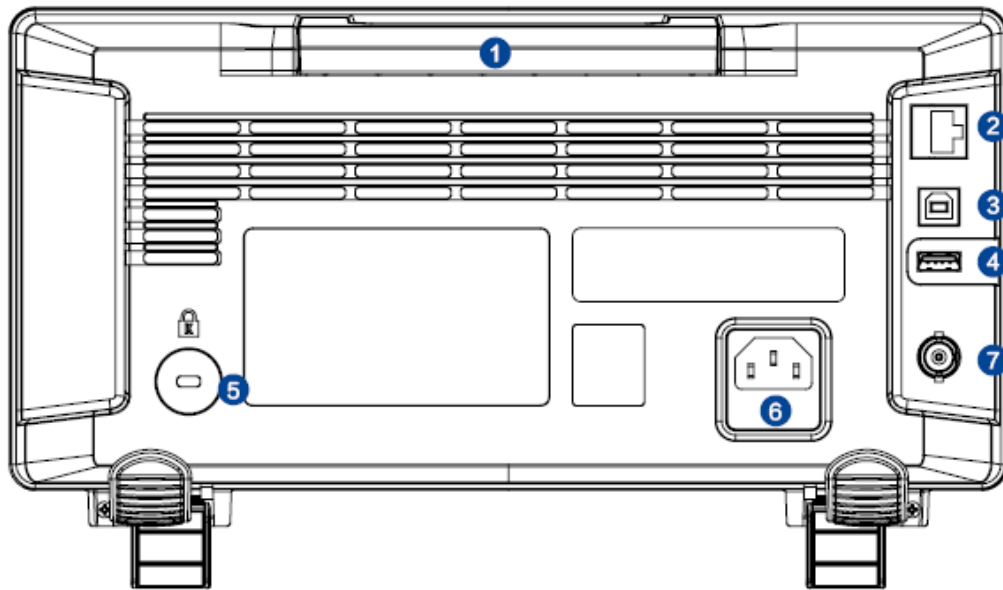

Figure 12 SDS1000X-E 4-channel Scope Rear panel Overview

1. **Handle**
Pull up the handle vertically for easy carrying of the instrument. When you do not need the handle, press it down.
2. **LAN**
The instrument can be connected to network via this interface to perform remote control.
3. **USB Device**
The oscilloscope support SCPI remote control commands, user can control the oscilloscope through this interface
4. **USB Host**
Communicate with external function generators (**SIGLENT** SDG and SAG1021I)
5. **Safety lock Hole**
You can lock the instrument to a fixed location using the security lock (please buy it yourself) via the lock hole.
6. **AC Power Socket**
AC power input terminal. The power requirements of this oscilloscope are 100-240 V, 50/60/400 Hz. Use the power cord provided with the instrument to connect it to AC power.
7. **Pass/Fail or Trigger Out**
The BNC port can output a signal that reflects the current waveform capture rate of the oscilloscope at each trigger or a pass/fail test pulse.

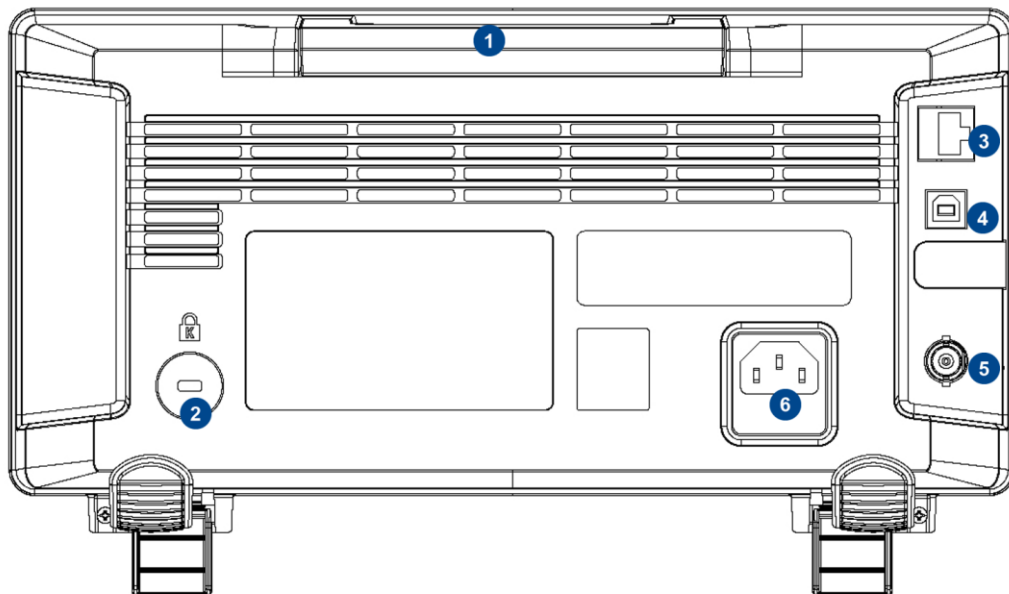

Figure 13 SDS1000X-U Scope Rear panel Overview

1. **Handle**
Pull up the handle vertically for easy carrying of the instrument. When you do not need the handle, press it down.
2. **Safety lock Hole**
You can lock the instrument to a fixed location using the security lock (please buy it yourself) via the lock hole.
3. **LAN**
The instrument can be connected to network via this interface to perform remote control.
4. **USB Device**
The oscilloscope support SCPI remote control commands, user can control the oscilloscope through this interface
5. **Pass/Fail or Trigger Out**
The BNC port can output a signal that reflects the current waveform capture rate of the oscilloscope at each trigger or a pass/fail test pulse.
6. **AC Power Socket**
AC power input terminal. The power requirements of this oscilloscope are 100-240 V, 50/60/400 Hz. Use the power cord provided with the instrument to connect it to AC power.

Front Panel Function Overview

Horizontal





4-channel scope



2-channel scope

 **Roll** : Quickly enter the roll mode. The timebase range is from 50mS/div to 100S/div.

 **Search** : Enable or disable search function. This function can search for the events that users specify in the acquired data, the results are displayed with white triangle symbol.

Horizontal Position Knob  : adjust horizontal position. Turn the knob to change the horizontal delay time, waveforms of all channels will move horizontally with the trigger point. Press down this knob to quickly reset the horizontal delay to Zero.

Horizontal Scale Knob  : adjust the horizontal time base. Turn clockwise to reduce the time base and turn counterclockwise to increase the time base. During the modification, waveforms of all the channels will be displayed in expanded or compressed mode and the time base message at the upper-left side of the screen would change accordingly. Press down this knob to quickly turn on Zoom function.

Vertical

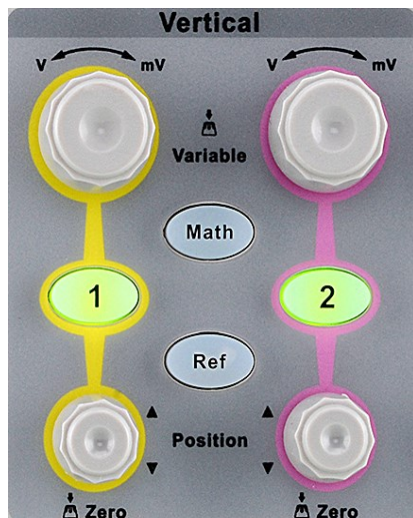



2-channel scope



4-channel scope

1 : Analog input channels. The two channels are marked by different colors which are also used to mark both the corresponding waveforms on the screen and the channel input connectors.

Vertical Position Knob  adjust the vertical position of the current channel waveform. Turn clockwise to increase the position and turn counterclockwise to decrease. During the modification, the waveform would move up and down and the position message at the lower-left corner of the screen would change accordingly. Press down this knob to quickly reset the vertical position to zero.

Vertical Variable Knob  : adjust the vertical scale of the current channel. Turn clockwise to decrease the scale and turn counterclockwise to increase. During the modification, the amplitude of the waveform would enlarge or reduce and the scale information at the right side of the screen would change accordingly. Press down this knob to quickly switch the vertical scale adjustment modes between "Coarse" and "Fine" .

Math : press the button to enter the MATH function menu. The oscilloscope provides addition, subtraction, multiplication, FFT, differential, integral and square root operations.

Ref : press the button to enter the REF function menu. A reference waveform can be displayed and compared against other waveforms.

Digital : Press the button to open the digital channel function menu (Optional function). The SDS1000X-E (4-channel scope) supports 16 digital channels.

Trigger

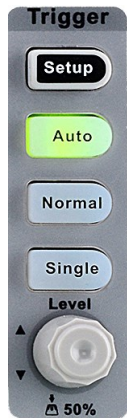

2-channel scope

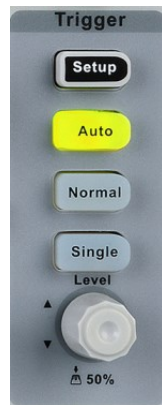

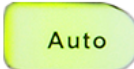

4-channel scope

 : press the button to enter the TRIGGER function menu. The oscilloscope provides abundant advanced trigger functions

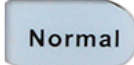
 : press the button to set the trigger mode to Auto.

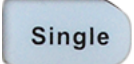
 : press the button to set the trigger mode to Normal.

 : press the button to set the trigger mode to Single.

Trigger Level Knob  : adjust the trigger level. Turn clockwise to increase the level and turn counterclockwise to reduce the level. During the modification, the trigger level line would move up and down and the value in the trigger level message box at the up-right corner of the screen would change accordingly. Press down the knob to quickly reset the trigger level to center of the waveform.

Run Control

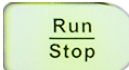

 : press this key to enable the waveform auto setting function. The oscilloscope will automatically adjust the vertical scale, horizontal time base and trigger mode according to the input signal to realize optimum waveform display.

 : press the button to set the acquisition state to Run or Stop.
In RUN state, the key is illuminated in yellow.
In STOP state, the key is illuminated in red.

Universal Knob



1. Adjust the waveform intensity.

You can press the **Display/Persist** button; press the **Next Page** soft key to go to the second page of the DISPLAY function menu; press the **Intensity** soft key and then turn the **Universal Knob** to adjust the waveform intensity.

2. Select the desired submenu.

In menu operation, press any menu soft key and turn the **Universal Knob** to select the desired submenu under the menu and push down the knob to confirm the current submenu. Turn clockwise to up the intensity and counterclockwise to down.

3. Modify parameters.

After having chosen a parameter, turn the **Universal Knob** to modify the value. Turn clockwise to increase the intensity and counterclockwise to reduce. In addition, it can also be used to adjust scale and offset of MATH and REF.

4. Choose file or directory or input filename.

After having entered the file system, turn the **Universal Knob** to select the desired file or directory. When inputting filename, turn the **Universal Knob** to select the desired character and the push the knob to confirm.

Menu



2-channel scope common function panel



4-channel scope common function panel

- Cursors** : Press to enter the CURSOR function menu. The oscilloscope provides manual and track cursor mode.
- Display Persist** : Press to enter the DISPLAY function menu and quickly enable the persist function. User can set the grid, intensity, graticule, and transparency.
- Utility** : Press to enter the UTILITY function menu to look at the system status, do self-calibration, set the sound, language and so on.
- Clear Sweeps** : The button is a shortcut key for clear function. When the measurement statistics is ON, press the button to clear the count and recount it. When persist is enabled, press the button to clear persist.
- Measure** : Press the button to enter the MEASURE function menu to set the measurement parameters, all measurement, statistics and gate.
- Acquire** : Press the button to enter the ACQUIRE function menu to set the acquisition mode, memory depth, wave interpolation and so on.



: Press the button to enter the SAVE/RECALL function menu to save setups, waveforms, pictures, or CSV files, binary data, matlab files, and default key presets to internal memory or USB flash driver.



: Press the button to reset the oscilloscope to user default setup.

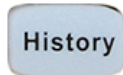

: Press the button to enter the history mode. In history mode, it can record most 80000 frames waveforms. If sequence function is enabled, it only record the frames which you set, the most you can set is 80000.

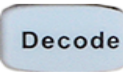

: Press the button to enter the DECODE function menu. The oscilloscope supports I2C, SPI, UART, CAN and LIN serial bus decode.



: Press the button to turn off or turn on the navigate function. SDS1000X-E (4-channel scope) and SDS1000X-U support three navigate types: time, search event, history frame.

Help

The oscilloscope has an on line help function that supplies multi-language help information.

You can access the help function by pressing any button for 2 seconds and a help window will explain the function. Also all of the submenus include help information.

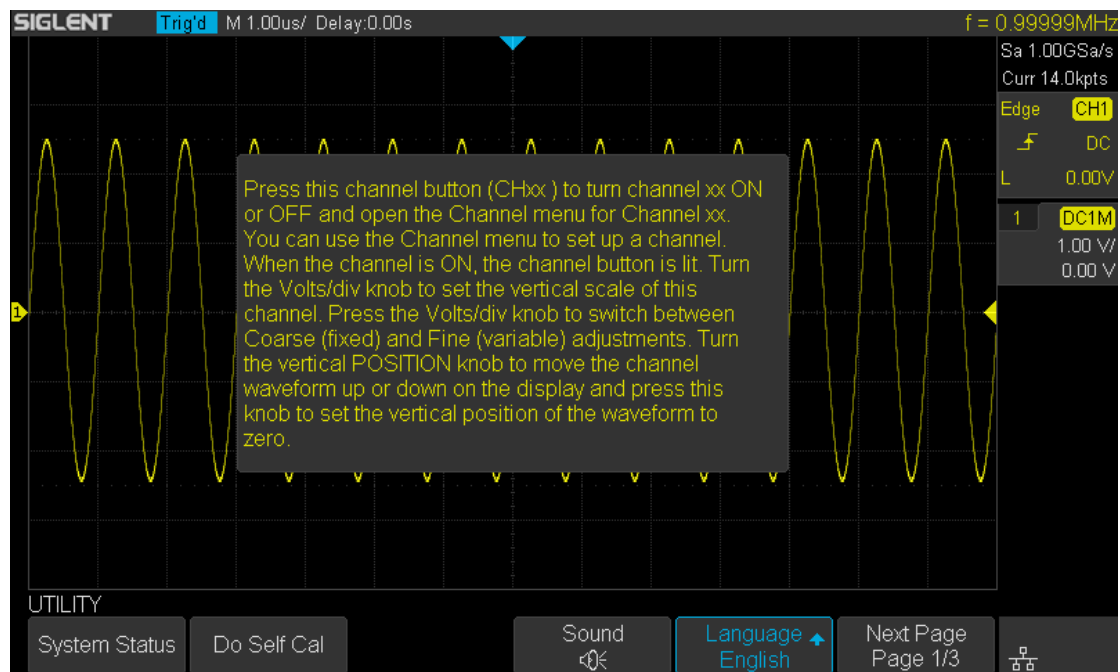

Figure 14 Help Message

User Interface

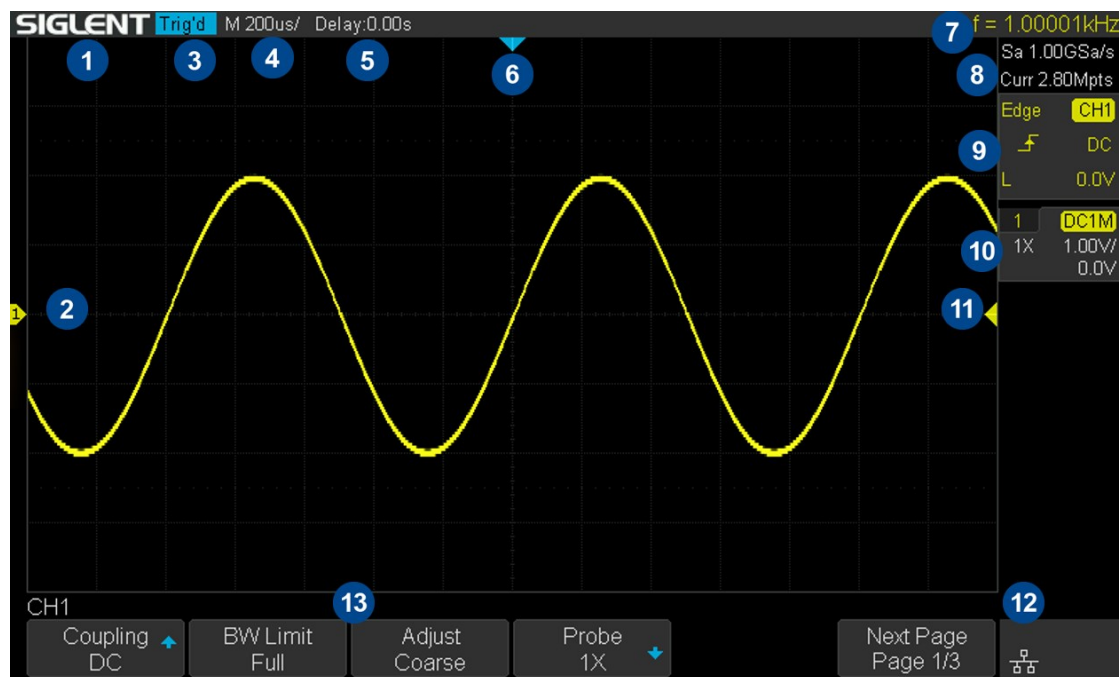

Figure 15 User Interface

1. **Product Logo**
SIGLENT is the registered trademark of SIGLENT TECHNOLOGIES CO., LTD.
2. **Channel Label/Waveform**
Different channels are marked by different colors and the color of the waveform complies with the color of the channel.
3. **Trigger Status**
Available trigger status includes Ready, Auto, Stop, Arm, Trig'd, FStop.
4. **Horizontal Time Base**
 - Represent the time per grid on the horizontal axis on the screen.
 - Use the **HORIZONTAL SCALE Knob** to adjust the parameter. The available range is from 1.0 ns to 100 s for SDS1000X-E; while from 2.0 ns to 100s for SDS1000X-U.
5. **Horizontal Position (Delay)**
Turn the Horizontal Position Knob to adjust the parameter. Push the knob to set the value to 0 automatically.

6. Trigger Delay Label

Indicate the trigger delay on the waveform.

7. Frequency Counter

Display the frequency value of the trigger channel.

8. Sampling Rate/ Memory Depth

Display the current sampling rate and memory depth. Sa means the current sampling rate and Curr means the current memory depth.

9. Trigger Setup

 Trigger Type: display the current trigger type. The trigger type names display by the abbreviation when the name is too long to display.

 Trigger source: display the currently trigger source. Different channels display in different color.

 Trigger condition: display the current trigger condition.

 Trigger coupling: display the current trigger coupling. Available trigger coupling mode: DC, AC, HF Reject, LF Reject.

 Trigger level: display the current value of trigger level. Push the knob to set the trigger to the 50% of the waveform amplitude automatically.

10. Channel Setup

 Probe attenuation factor: display the current probe attenuation factor of the channel. Available probe attenuation factors: 0.1X, 0.2X, 0.5X, 1X, properties 2000X, 5000X, 10000X.

 Input impedance: display the current input impedance of the channel. Input impedance that available: 1MΩ.

 Channel coupling: display the current channel coupling of the channel. Channel coupling that available: DC, AC, and GND.

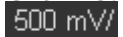
 Vertical Scale: display the current vertical scale of the channel. Turn the Vertical Scale Knob to adjust the value.

11. Trigger Level Label

Display the position of trigger level, the color is the same to the trigger channel. It can move from +4.5div to -4.5div of the screen center.

12. I/O status

 Indicate that the USB Host is connected.

 Indicate that the LAN port is connected.

 Indicate that the LAN port is disconnected.

 Indicate that the WLAN port is connected.

 Indicate that the WLAN port is disconnected.

13. Menu

Display the corresponding function menu of the selected button. Press the corresponding soft key to set the oscilloscope.

Security Lock

If needed, you can use the security lock (please buy it yourself) to lock the oscilloscope to a fixed location. The method is as follows, align the lock with the lock hole and plug it into the lock hole vertically, turn the key clockwise to lock the oscilloscope and then pull the key out.

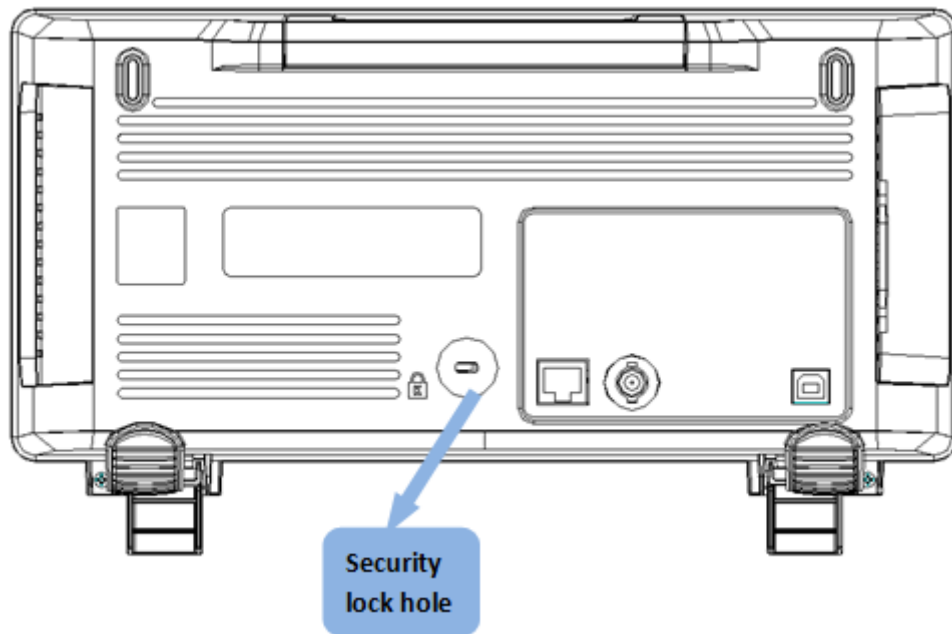

Figure 16 to Use the Security Lock

Vertical System

This chapter introduces how to set the vertical system of the oscilloscope.

The contents of this chapter:

- ◆ Enable the Channel
- ◆ Adjust Scale
- ◆ Vertical Position
- ◆ Coupling
- ◆ Bandwidth Limit
- ◆ Probe
- ◆ Unit
- ◆ Deskew
- ◆ Invert
- ◆ Trace Visible/Hidden
- ◆ Label

Enable the Channel

The oscilloscope provides 2/4 analog input channels and provides independent vertical control system for each channel. As the vertical system setting methods of every channel is the same, this chapter takes CH1 as an example to introduce the setting method of the vertical system.

Connect a signal to the CH1 channel connector; and then press the **CH1** button in the vertical control area (VERTICAL) at the front panel to enable CH1.

The channel setting menu is displayed at the bottom of the screen and the channel label at the right side of the screen. The information displayed in the channel label is related to the current channel setting.

After the channel is turned on, modify the parameters such as the vertical scale, the horizontal time base and the trigger mode according to the input signal to make the waveform display easy to observe and measure.

Note: to turn off the channel, press the channel button twice.

Adjust Scale

The vertical scale can be adjusted in **Coarse** or **Fine** mode.

- **Coarse** adjustment (take counterclockwise as an example): set the vertical scale in 1-2-5 step namely 500uV/div, 1 mV/div, 2 mV/div, 5 mV/div, 10 mV/div ...10 V/div.
Fine adjustment: further adjust the vertical scale within a relatively smaller range to improve vertical resolution. For example: 2 V/div, 1.98V/div, 1.96V/div, 1.94 V/div ...1 V/div.
- If the amplitude of the input waveform is a little bit greater than the full scale under the current scale and the amplitude would be a little bit lower if the next scale is used, fine adjustment can be used to improve the amplitude of waveform display to view signal details.

Press the **CH1** button on the front panel; then press the **Adjust** soft key to select the desired mode. Turn the **VERTICAL Variable Knob** to adjust the vertical scale (clockwise to reduce the scale and counterclockwise to increase).

The scale information in the channel label at the right side of the screen will change accordingly during the adjustment. The adjustable range of the vertical scale is related to the probe ratio currently set. By default, the probe attenuation factor is 1X and the adjustable range of the vertical scale is from 500uV/div to 10 V/div.

Note: push the **VERTICAL Variable Knob** to quickly switch between **Coarse** and **Fine** adjustments.

Vertical Position

Turn the **VERTICAL Position Knob** to adjust the vertical position of the channel waveform. Turn the knob clockwise to increase the vertical position and the channel waveform moves up while counterclockwise to reduce the vertical position and the waveform moves down. Push the knob to set the vertical position of the channel waveform to zero.

During the adjustment, the vertical position information Volts Pos displays at the bottom of the screen. The table below shows the range of vertical position according to the volt scale.

Oscilloscope	Volt Scale	Range of Vertical Position
SDS1000X-E	500 μ V/div ~ 100 mV/div	\pm 2V
	102 mV/div ~ 1 V/div	\pm 20 V
	1.02 V/div ~ 10 V/div	\pm 200 V
SDS1000X-U	1mV/div ~ 200 mV/div	\pm 2 V
	206 mV/div ~ 10 V/div	\pm 100 V

Coupling

Set the coupling mode to filter out the undesired signals. For example, the signal under test is a square waveform with DC offset.

- When the coupling mode set to **DC**: the DC and AC components of the signal under test can both pass the channel.
- When the coupling mode set to **AC**: the DC components of the signal under test are blocked.
- When the coupling mode set to **GND**: the DC and AC components of the signal under test are both blocked.

Press the **CH1** button on the front panel; then press the **Coupling** softkey and turn the **Universal Knob** to select the desired coupling mode. The default setup is **DC**.

The current coupling mode is displayed in the channel label at the right side of the screen. You can also press the **Coupling** softkey continuously to switch the coupling mode.

Bandwidth Limit

Set the bandwidth limit to reduce display noise. For example, the signal under test is a pulse with high frequency oscillation.

- When the bandwidth limit set to **Full**, the high frequency components of the signal under test can pass the channel.
- When the bandwidth limit set to **20M**, the high frequency components that exceed 20 MHz are attenuated.

Press the **CH1** button on the front panel; then press the **BW Limit** softkey to select **Full** or **20M**. The default setup is **Full**. When bandwidth limit is enabled, the character **B** will be displayed in the channel label at the right side of the screen.

Probe

Set the probe attenuation factor to match the type of the probe that you are using to ensure correct vertical readouts.

Press the **CH1** button on the front panel; then press the **Probe** softkey and turn the **Universal Knob** to select the desired value and push the knob to confirm. The default setup is **1X**.

The current probe attenuation factor is displayed in the channel label at the right side of the screen. You can also press the **Probe** softkey continuously to switch the probe attenuation factor.

The table shows the probe attenuation factor

Menu	Attenuation Factor
0.1X	0.1 : 1
0.2X	0.2 : 1
0.5X	0.5 : 1
1X	1 : 1
2X	2 : 1
...	...
5000X	5000 : 1
10000X	10000 : 1
Custom	1000000:1~0.000001:1

You can also customize the probe attenuation factor. Press the **Probe** softkey, select **Custom**, and then press the **Custom** softkey to select **Custom** or **Custom Fine**. First, select **Custom** and turn the **Universal Knob** to achieve rough adjustment; and then select **Custom Fine** and turn the **Universal Knob** to achieve fine adjustment.

Unit

Select the amplitude display unit for the current channel. The available units are **V** and **A**. When the unit is changed, the unit displayed in the channel label will change accordingly.

1. Press **CH1** button on the front panel to enter the CH1 function menu.
2. Press the **Next Page** softkey to enter the second page of the CH1 function menu.
3. Press the **Unit** softkey to select the desired unit **V** or **A**.

The default setup is **V**.

Deskew

The valid range of each analog channel is $\pm 100\text{ns}$.

1. Press **CH1** button on the front panel to enter the CH1 function menu.
2. Press the **Next Page** softkey to enter the second page of the CH1 function menu.
3. Press the **Deskew** softkey. Then turn the **Universal Knob** to change deskew.

Invert

When **Invert** is set to **On**, the voltage values of the displayed waveform are inverted. Invert affects how a channel is displayed and it keeps the trigger settings.

Inverting a channel also changes the result of any math function selected and

measure function.

1. Press **CH1** button on the front panel to enter the CH1 function menu.
2. Press the **Next Page** softkey to enter the second page of the CH1 function menu.
3. Press the **Invert** softkey to turn on or off the invert display.

Trace Visible/Hidden

Set whether the current channel waveform is visible.

1. Press **CH1** button on the front panel to enter the CH1 function menu.
2. Press the **Next Page** softkey to enter the second page of the CH1 function menu.
3. Press the **Trace** softkey to visible or hidden the channel waveform

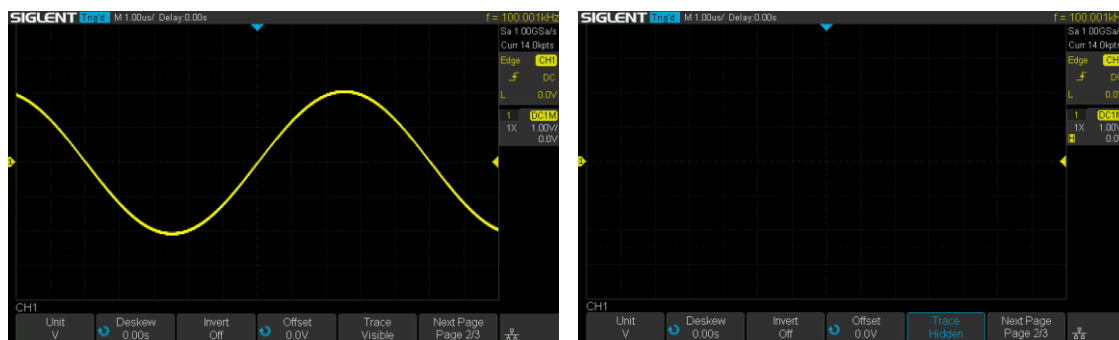

Trace Visible

Trace Hidden

Label

SDS1000X-E (4-channel) supports setting label text for channels.

1. Press **CH1** → **Label** to enter the LABEL function menu.
2. Press the **Source** softkey to select the source.
3. Press the **Display** softkey to turn on or off the label for the current channel.
4. Press the **Label Setting** softkey to enter the Text Input function menu. The length of the label is limited to 20 characters. The characters beyond this length will not be displayed. When the “Display” option is set to “on”, the

label will be displayed on the right side of the channel offset indicator.



Figure 17 CH1 Label Display

Horizontal System

This chapter introduces how to set the horizontal system of the oscilloscope.

The contents of this chapter:

- ◆ Horizontal Scale
- ◆ Horizontal Delay
- ◆ Roll Mode
- ◆ Zoom Mode

Horizontal Scale

Turn the **HORIZONTAL Scale Knob** on the front panel to adjust the horizontal time base. Turn clockwise to reduce the horizontal time base and turn counterclockwise to increase.

The time base information at the upper left corner of the screen will change accordingly during the adjustment. The range of the SDS1000X-E horizontal scale is from 1ns/div to 100s/div. The range of the SDS1000X-U horizontal scale is from 2ns/div to 100s/div.

The **Horizontal Scale Knob** works (in the Normal time mode) while acquisitions are running or when they are stopped. When in run mode, adjusting the horizontal scale knob changes the sample rate. When stopped, adjusting the horizontal scale knob lets you zoom into acquired data.

Horizontal Delay

Turn the **Horizontal Position** Knob on the front panel, the trigger point (solid inverted triangle) will move horizontally. The trigger point moves horizontally to the right when it rotates clockwise, while moves to left when it rotates counter-clockwise. Press down this knob to quickly reset the trigger delay.

When changing the horizontal delay, the delay time displayed in the information bar at the top of the screen changes in real time, indicating the distance between the time reference point and the trigger point. The amount of delay range available depends on the time/div selected and memory depth.

Roll Mode

Press the **Roll** button to enter the roll mode.

In Roll mode the waveform moves slowly across the screen from right to left. It only operates on time base settings of 50 ms/div and slower. If the current time base setting is faster than the 50 ms/div limit, it will be set to 50 ms/div when Roll mode is entered.

In Roll mode there is no trigger. The fixed reference point on the screen is the right edge of the screen and refers to the current moment in time. Events that have occurred are scrolled to the left of the reference point. Since there is no trigger, no pre-trigger information is available.

If you would like to stop the display in Roll mode, press the **Run/Stop** button. To clear the display and restart an acquisition in Roll mode, press the **Run/Stop** button again.

Use Roll mode on low-frequency waveforms to yield a display much like a strip chart recorder. It allows the waveform to roll across the display.

Zoom Mode

Zoom is a horizontally expanded version of the normal display. You can use Zoom to locate and horizontally expand part of the normal window for a more detailed (higher- resolution) analysis of signals.

Press the **HORIZONTAL Scale Knob** on the front panel to turn on the zoom function, and press the button again to turn off the function. When Zoom function is on, the display divides in half. The top half of the display shows the normal time base window and the bottom half displays a faster Zoom time base window.

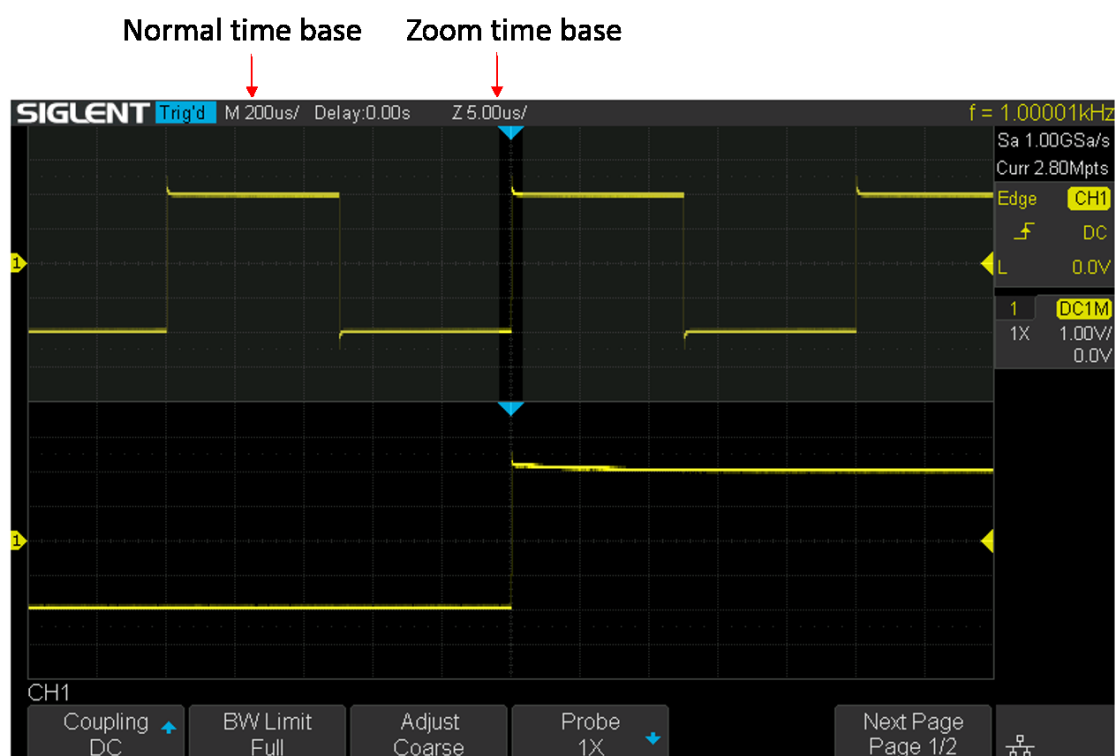

Figure 18 Split Screen Zoom

The area of the normal display that is expanded is outlined with a box and the rest of the normal display is ghosted. The box shows the portion of the normal sweep that is expanded in the lower half.

To change the time base for the Zoom window, turn the **Horizontal Scale Knob**. The **Horizontal Scale Knob** controls the size of the box. The **Horizontal Position Knob** sets the left- to- right position of the zoom window. The delay value, which is the time displayed relative to the trigger point is momentarily displayed in the upper-right corner of the display when the **Horizontal Position Knob** is turned. Negative delay values indicate you're looking at a portion of the waveform before the trigger

event, and positive values indicate you're looking at the waveform after the trigger event.

To change the time base of the normal window, turn off Zoom; then, turn the **Horizontal Scale Knob**.

Sample System

This chapter introduces how to use the run control and set the sampling system of the oscilloscope.

The contents of this chapter:

- ◆ Run Control
- ◆ Overview
- ◆ Memory Depth
- ◆ Sampling Mode
- ◆ Interpolation Method
- ◆ Acquisition Mode
- ◆ Horizontal Format
- ◆ Sequence Mode

Run Control

Press the **Run/Stop** or **Single** button on the front panel to run or stop the sampling system of the scope.

- When the **Run/Stop** button is green, the oscilloscope is running, that is, acquiring data when trigger conditions are met. To stop acquiring data, press the **Run/Stop** button. When stopped, the last acquired waveform is displayed.
- When the **Run/Stop** button is red, data acquisition is stopped. Red "Stop" is displayed next to the trademark logo in the status line at the top of the display. To start acquiring data, press **Run/Stop**.
- To capture and display a single acquisition (whether the oscilloscope is running or stopped), press **Single**. The **Single** run control lets you view single-shot events without subsequent waveform data overwriting the display. Use **Single** when you want maximum memory depth for pan and zoom.

When you press **Single**, the display is cleared, the trigger mode is temporarily set to Normal (to keep the oscilloscope from auto-triggering immediately), the trigger circuitry is armed, the **Single** key is illuminated, and the oscilloscope waits until a user defined trigger condition occurs before it displays a waveform.

When the oscilloscope triggers, the single acquisition is displayed and the oscilloscope is stopped (the **Run/Stop** button is illuminated in red).

Press **Single** again to acquire another waveform.

Overview

To understand the oscilloscope's sampling and acquisition modes, it is helpful to understand sampling theory, sample rate and oscilloscope bandwidth and sample rate.

Sampling Theory

The Nyquist sampling theorem states that for a limited bandwidth (band- limited) signal with maximum frequency f_{MAX} , the equally spaced sampling frequency f_s must be greater than twice the maximum frequency f_{MAX} , in order to have the signal be uniquely reconstructed without aliasing.

$$f_{MAX} = f_{s/2} = \text{Nyquist frequency } (f_N) = \text{folding frequency}$$

Sample Rate

The maximum sample rate of the oscilloscope is 2GSa/s. The actual sample rate of the oscilloscope is determined by the horizontal scale. Turn the **Horizontal Scale Knob** to adjust the sample rate.

The actual sample rate is displayed in the information area at the upper- right corner of the screen.

The influence on the waveform when the sample rate is too low:

1. **Waveform Distortion:** when the sample rate is too low, some waveform details are lost and the waveform displayed is rather different from the actual signal.

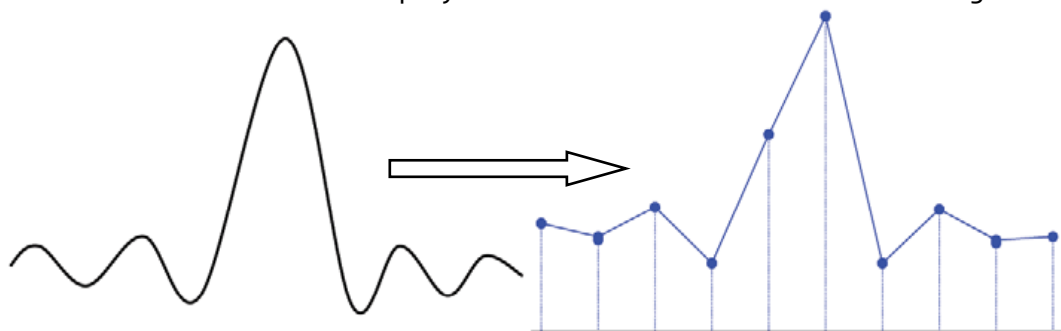

2. **Waveform Confusion:** when the sample rate is lower than twice the actual signal frequency (Nyquist Frequency), the frequency of the waveform rebuilt from the sample data is lower than the actual signal frequency. The most common aliasing is the jitter on fast edge.

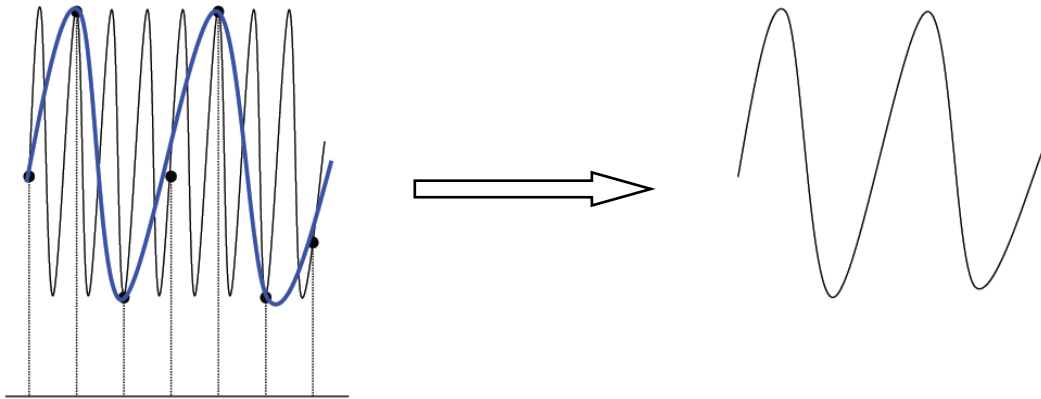

3. **Waveform Leakage:** when the sample rate is too low, the waveform rebuilt from the sample data does not reflect all the actual signal information.

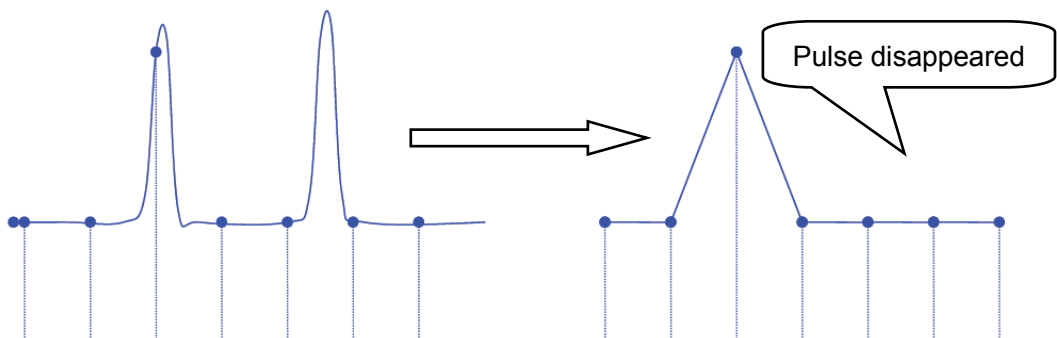

Bandwidth and Sample Rate

An oscilloscope's bandwidth is typically described as the lowest frequency at which input signal sine waves are attenuated by 3 dB (- 30% amplitude error).

At the oscilloscope bandwidth, sampling theory says the required sample rate is $f_s = 2f_{BW}$. However, the theory assumes there are no frequency components above f_{MAX} (f_{BW} in this case) and it requires a system with an ideal brick-wall frequency response.

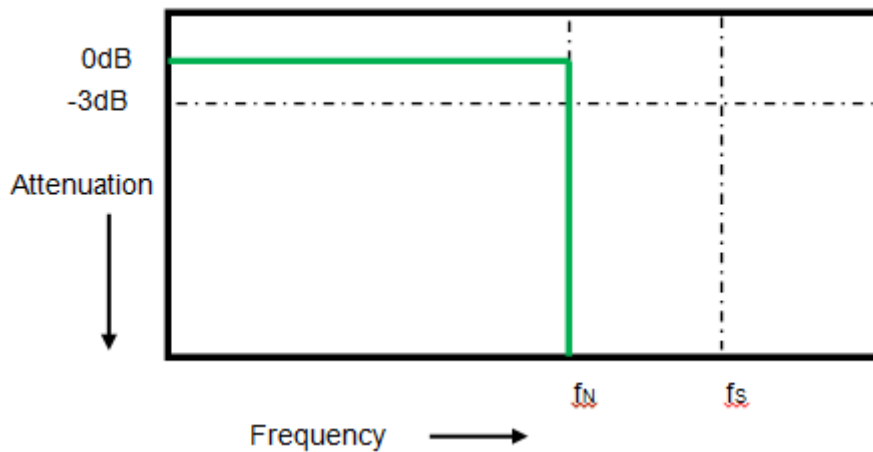

However, digital signals have frequency components above the fundamental frequency (square waves are made up of sine waves at the fundamental frequency and an infinite number of odd harmonics), and typically, for 500 MHz bandwidths and below, oscilloscopes have a Gaussian frequency response.

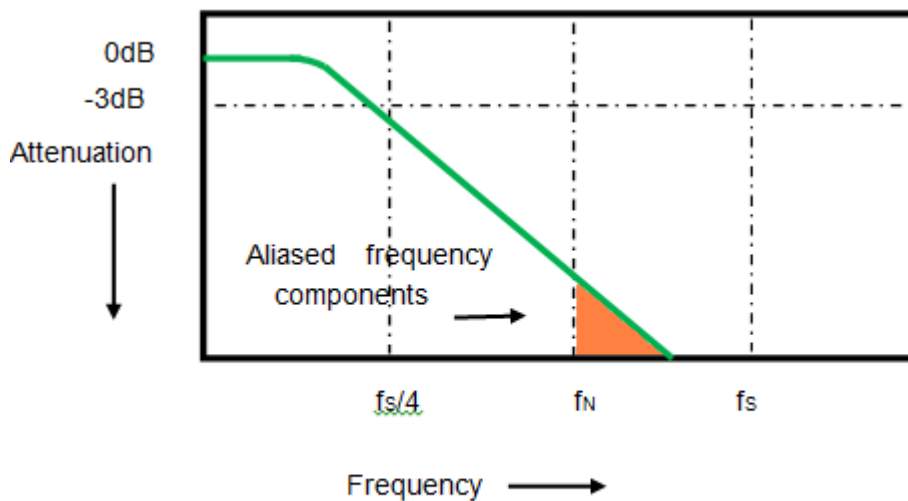

Limiting oscilloscope bandwidth (f_{BW}) to 1/4 the sample rate ($f_s/4$) reduces frequency components above the Nyquist frequency (f_N).

So, in practice, an oscilloscope's sample rate should be four or more times its bandwidth: $f_s = 4f_{BW}$. This way, there is less aliasing, and aliased frequency components have a greater amount of attenuation.

Memory Depth

Memory depth refers to the number of waveform points that the oscilloscope can store in a single trigger sample and it reflects the storage ability of the sample memory.

Press the **Acquire** button on the front panel; press the **Mem Depth** softkey and then turn the **Universal Knob** to select the desired value and push down the knob to confirm. Press the **Mem Depth** softkey continually can also select the desired value.

The actual memory depth is displayed in the information area at the upper- right corner of the screen. Since the oscilloscope of SDS1000X-E has two acquisition memories, when only one channel is on, the maximal memory depth is up to 14 Mpts. SDS1000X-U only has one acquisition memory, when only one channel is on, the maximal memory depth is up to 14 Mpts.

The maximum storage depth in single channel mode is twice that in dual channel mode, as shown in the following table:

SDS1000X-E		SDS1000X-U		
Single Channel Mode	Dual Channel Mode	Single Channel Mode	Dual Channel Mode	Three or Four Channel Mode
14k	7k	14k	7k	3.5k
140k	70k	140k	70k	35k
1.4M	700k	1.4M	700k	350k
14M	7M	14M	7M	3.5M

The relation of memory depth, sample rate and waveform length fulfills the equation below:

$$\text{Memory depth} = \text{sample rate (Sa/s)} \times \text{waveform length (s/div} \times \text{div)}$$

Sampling Mode

The oscilloscope only supports real-time sample. In this mode, the oscilloscope samples and displays waveform within a trigger event. The maximum real-time sample rate is 1GSa/s.

Press the **RUN/STOP** button to stop the sample, the oscilloscope will hold the last display. At this point, you can still use the vertical control and horizontal control to

pan and zoom the waveform.

Interpolation Method

Under real-time sampling, the oscilloscope acquires the discrete sample values of the waveform being displayed. In general, a waveform of dots display type is very difficult to observe. In order to increase the visibility of the signal, the digital oscilloscope usually uses the interpolation method to display a waveform.

Interpolation method is a processing method to “connect all the sampling points” , and using some points to calculate the whole appearance of the waveform. For real-time sampling interpolation method is used, even if the oscilloscope in a single captures only a small number of sampling points. The oscilloscope can use interpolation method for filling out the gaps between points, to reconstruct an accurate waveform.

Press the **Acquire** button on the front panel to enter the ACQUIRE Function menu; then press the **Interpolation** softkey to select **Sinx/x** or **X**.

- **X:** In the adjacent sample points are directly connected on a straight line. This method is only confined to rebuild on the edge of signals, such as square wave.
- **Sinx/x:** Connecting the sampling points with curves has stronger versatility. Sinx interpolation method uses mathematical processing to calculation results in the actual sample interval. This method bending signal waveform, and make it produce more realistic regular shape than pure square wave and pulse. When the sampling rate is 3 to 5 times the bandwidth of the system. Recommended Sinx/s interpolation method.

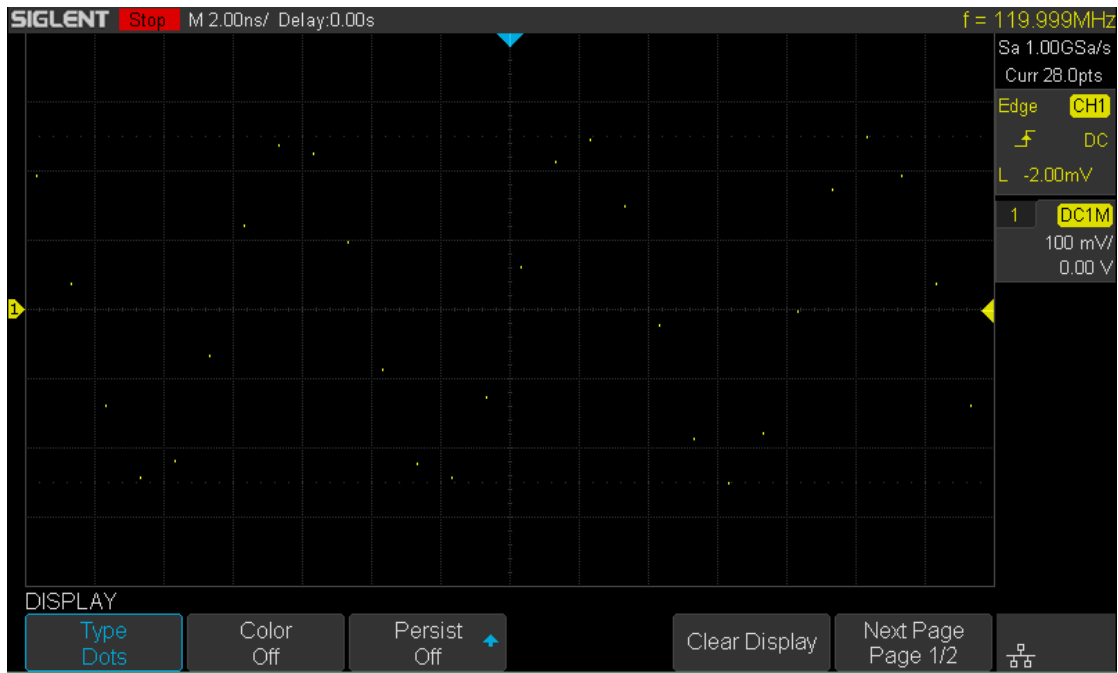

Figure 19 Display Type Set to Dots

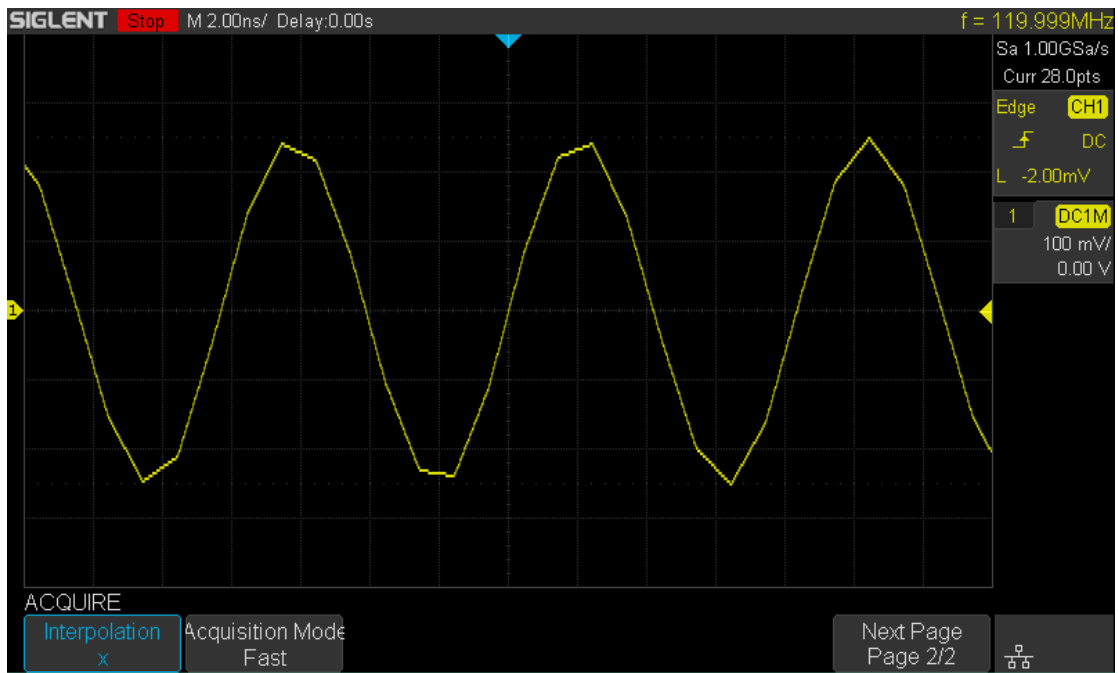

Figure 20 x Interpolation

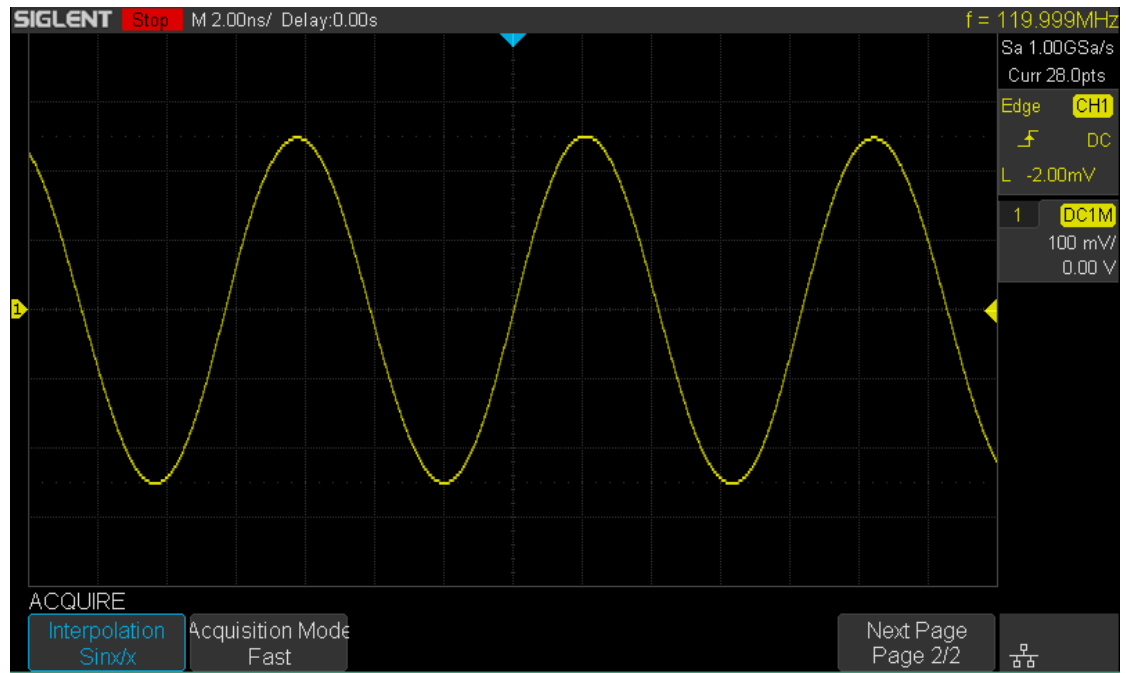

Figure 21 Sinx/x Interpolation

Acquisition Mode

The acquisition mode is used to control how to generate waveform points from sample points. The oscilloscope provides the following acquisition mode: Normal, Peak Detect, Average and Eres.

1. Press the **Acquire** button on the front panel to enter the ACQUIRE function menu;
2. Press the **Acquisition** softkey; then turn the **Universal Knob** to select the desired acquisition mode and push down the knob to confirm. The default setup is **Normal**.

Normal

In this mode, the oscilloscope samples the signal at equal time interval to rebuild the waveform. For most of the waveforms, the best display effect can be obtained using this mode. It is the default acquisition mode.

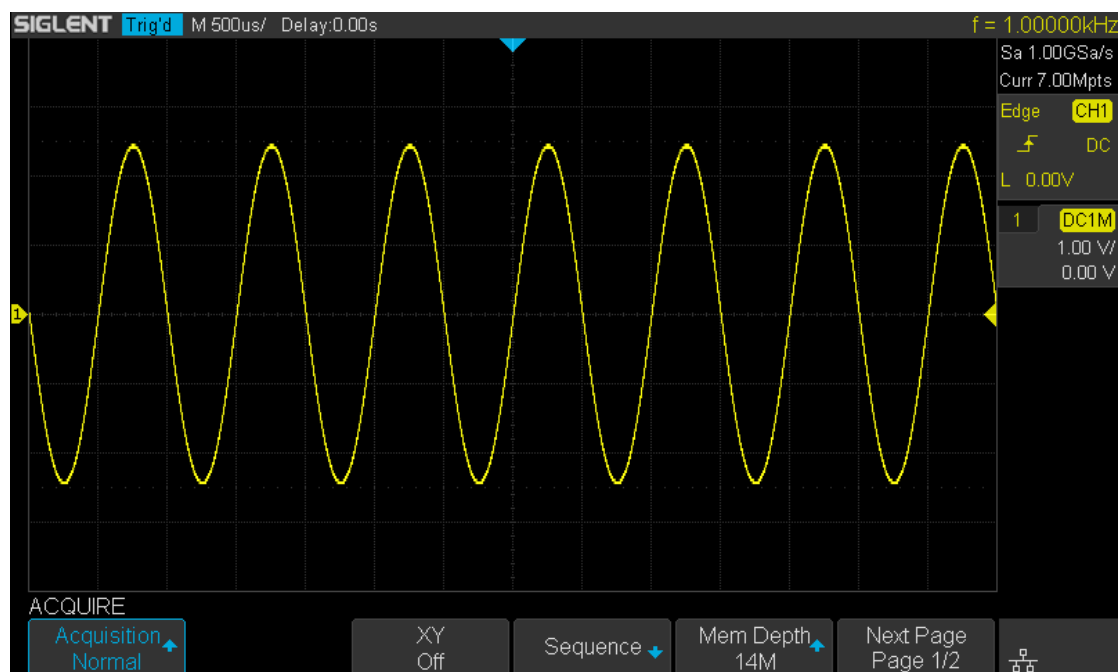

Figure 22 Acquisition System

Peak Detect

In this mode, the oscilloscope acquires the maximum and minimum values of the signal within the sample interval to get the envelope of the signal or the narrow pulse of the signal that might be lost. In this mode, signal confusion can be prevented but the noise displayed would be larger.

In this mode, the oscilloscope can display all the pulses with pulse widths at least as wide as the sample period.

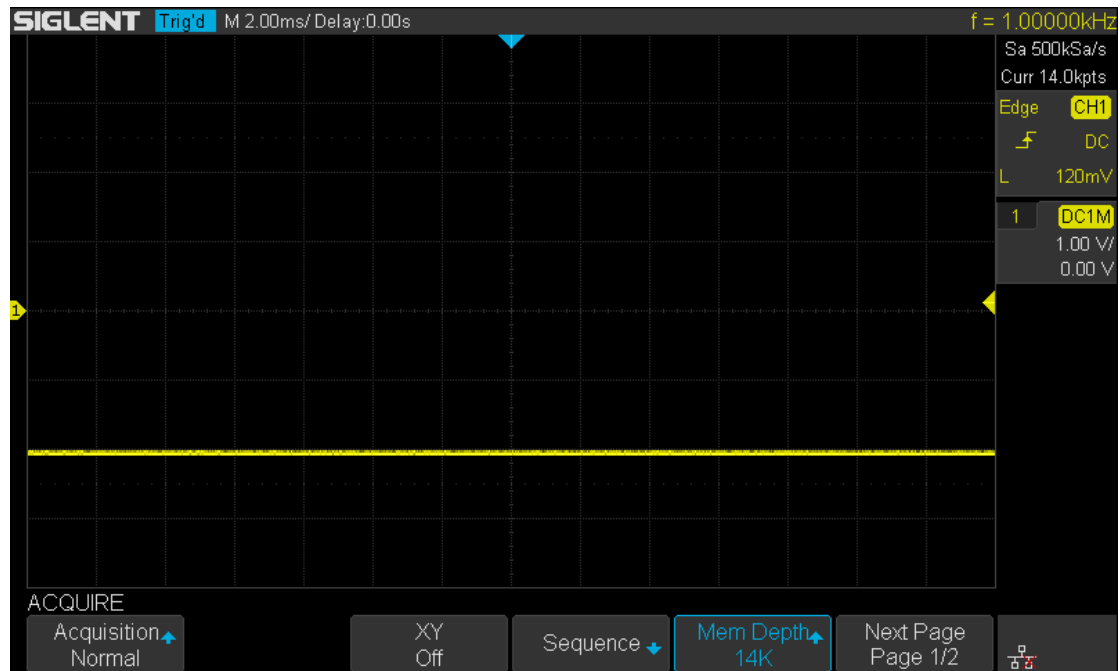

Figure 23 Pulse With 0.1% Duty, Normal Mode



Figure 24 Pulse With 0.1% Duty, Peak Detect Mode

Average

In this mode, the oscilloscope averages the waveforms from multiple samples to reduce the random noise of the input signal and improve the vertical resolution. The greater the number of averages is, the lower the noise will be and the higher the vertical resolution will be but the slower the response of the displayed waveform to the waveform changes will be.

The available range of averages is from 4 to 1024 and the default is 16. When Average mode is selected, press **Averages** and turn the **Universal knob** or press the softkey continually to set the desired average time.

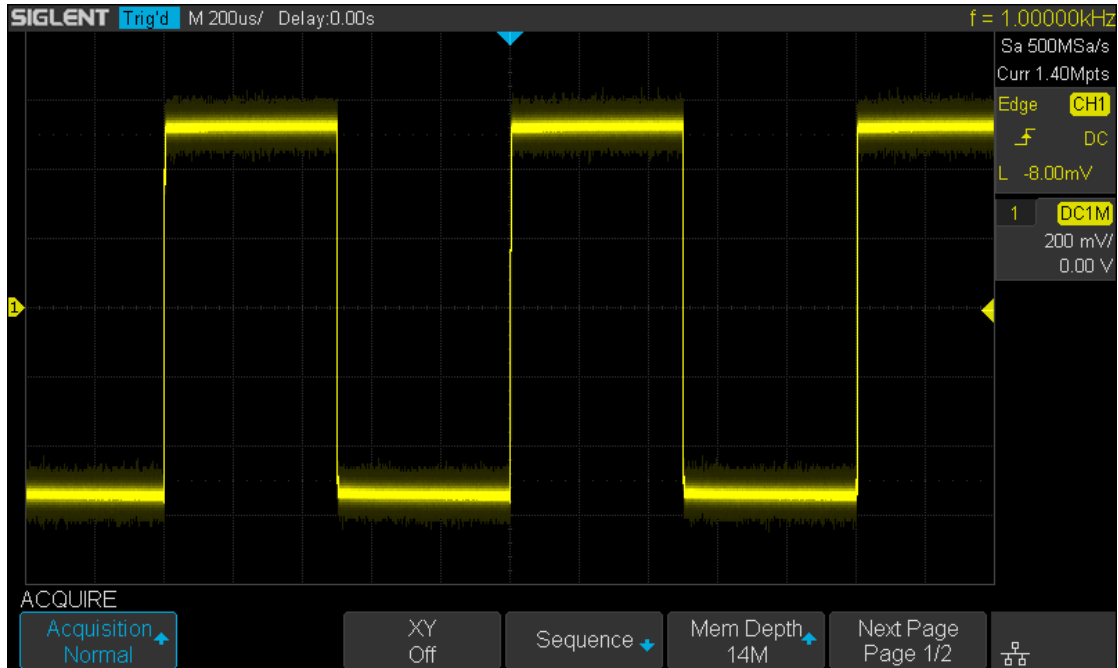

Figure 25 with Random Noise, Normal Mode

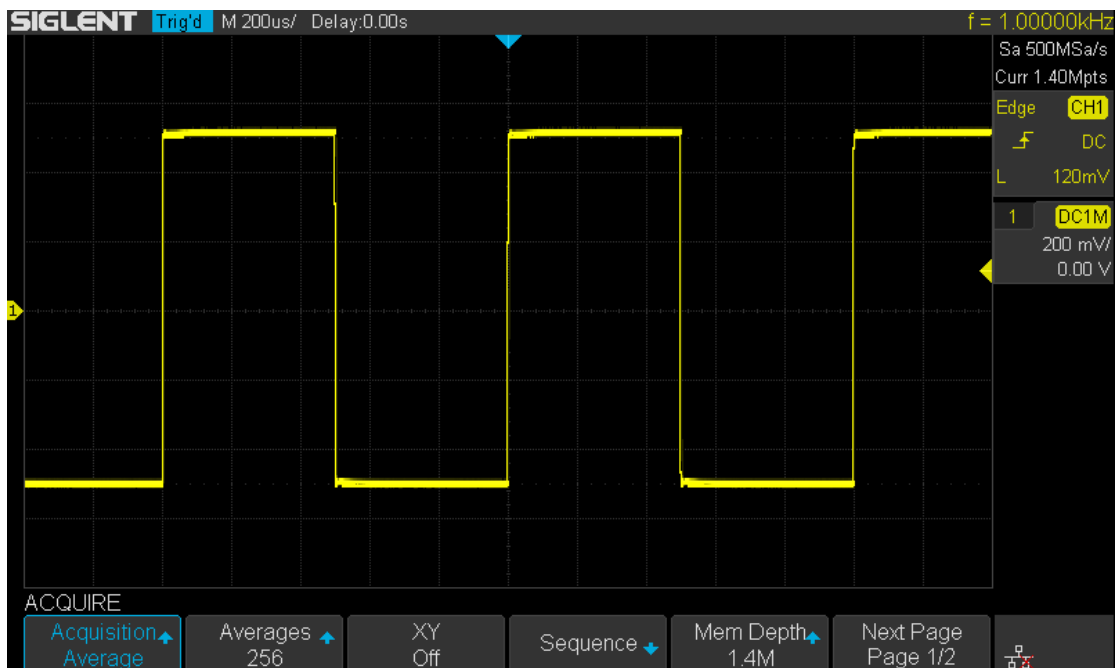

Figure 26 with Random Noise, Average Mode

Eres

This mode uses a kind of ultra-sample technique to average the neighboring points

of the sample waveform to reduce the random noise on the input signal and generate much smoother waveforms on the screen. This is generally used when the sample rate of the digital converter is higher than the storage rate of the acquisition memory.

Eres mode can be used on both single- shot and repetitive signals and it does not slow waveform update. This mode limits the oscilloscope's real- time bandwidth because it effectively acts like a low- pass filter.

Note: “Average” and “Eres” modes use different averaging methods. The former uses “Waveform Average” and the latter uses “Dot Average” .

Horizontal Format

Press the **Acquire** button on the front panel; then press the **XY** soft key to set the XY(On) or YT(Off) mode. The default setup is **YT**.

YT

It is the normal viewing mode for the oscilloscope. In the Normal time mode, signal events occurring before the trigger are plotted to the left of the trigger point and signal events after the trigger plotted to the right of the trigger point.

XY

XY mode changes the display from a volt- versus- time display to a volt- versus- volt display. Channel 1 amplitude is plotted on the X- axis and Channel 2 amplitude is plotted on the Y- axis, the two channels will be turned on or off together.

You can use XY mode to compare frequency and phase relationships between two signals. XY mode can also be used with transducers to display strain versus displacement, flow versus pressure, volts versus current, or voltage versus frequency.

The phase deviation between two signals with the same frequency can be easily measured via Lissajous method. The figure below shows the measurement schematic diagram of the phase deviation

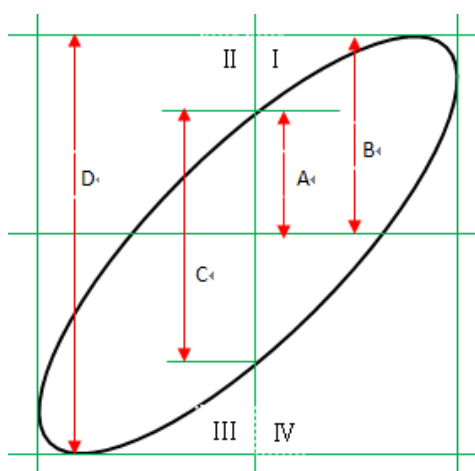

According to $\sin\theta=A/B$ or C/D (wherein, θ is the phase deviation angle between the two channels and the definitions of A, B, C and D are as shown in the figure above), the phase deviation angle is obtained, that is: $\theta=\pm\arcsin (A/B)$ or $\pm\arcsin (C/D)$

If the principal axis of the ellipse is within quadrant I and III, the phase deviation angle obtained should be within quadrant I and IV, namely within $(0 \text{ to } \pi/2)$ or $(3\pi/2 \text{ to } 2\pi)$. If the principal axis of the ellipse is within quadrant II and IV, the phase deviation angle obtained should be within quadrant II and III, namely within $(\pi/2 \text{ to } \pi)$ or $(\pi \text{ to } 3\pi/2)$.

X-Y function can be used to measure the phase deviation occurred when the signal under test passes through a circuit network. Connect the oscilloscope to the circuit to monitor the input and output signals of the circuit.

Sequence Mode

Sequence is also a kind of acquisition mode, which does not display waveform during sampling process. It improves the waveform capture rate, and the maximal capture rate is 400,000 wfs/s. So it can capture the small probability event effectively.

The oscilloscope runs and fills a memory segment for each trigger event. The oscilloscope is busy acquiring multiple segments. The oscilloscope continues to trigger until memory is filled, and then display the waveforms on the screen.

To use the sequence mode, the HORIZONTAL Format must be set to **YT**.

Do the following steps to use the sequence mode.

1. Press the **Acquire** button on the front panel to enter the ACQUIRE function menu;
2. Press the **Sequence** softkey to enter the SEQUENCE function menu.



Figure 27 SEQUENCE Function Menu

3. Press the **Segments Set** softkey; and then turn the **Universal Knob** to select the desired value.

Do the following steps to replay the sequence waveform under history mode:

1. Press the **History** softkey to enable HISTORY function.

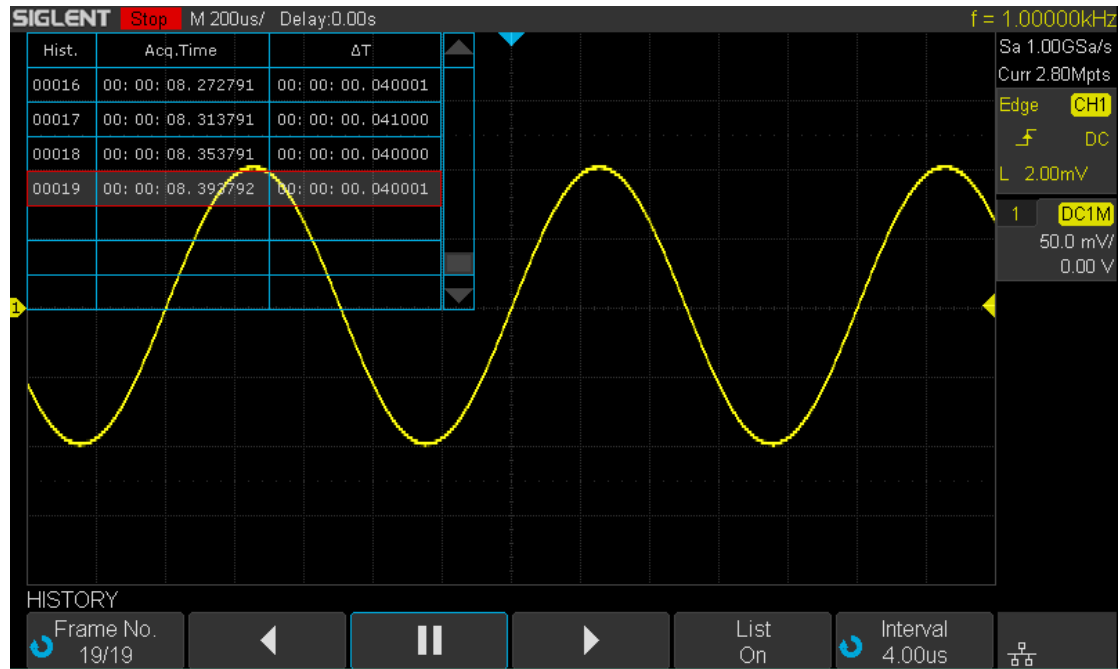

Figure 28 HISTORY Function Menu

2. Press the **List** softkey to turn on the list display. The list records the acquisition time of every frame and shows the frame number that displaying on the screen.
3. Press the **Frame No.** softkey; and then turn the **Universal Knob** to select the frame to display.
4. Press the **◀** softkey to replay the waveform from the current frame to 1.
5. Press the **||** softkey to stop replay.
6. Press the **▶** softkey to replay the waveform from the current frame to the last frame.

Trigger

For trigger, you set certain trigger condition according to the requirement and when a waveform in the waveform stream meets this condition, the oscilloscope captures this waveform as well as the neighboring part and displays them on the screen. For digital oscilloscope, it displays waveform continuously no matter whether it is stably triggered, but only stable trigger can ensure stable display. The trigger circuit ensures that every time base sweep or acquisition starts from the input signal and the user-defined trigger condition, namely every sweep is synchronous to the acquisition and the waveforms acquired overlap to display stable waveform.

The following is the schematic diagram of the acquisition memory. As shown in the figure below, the position of the trigger event is determined by the reference time point and the delay setting.

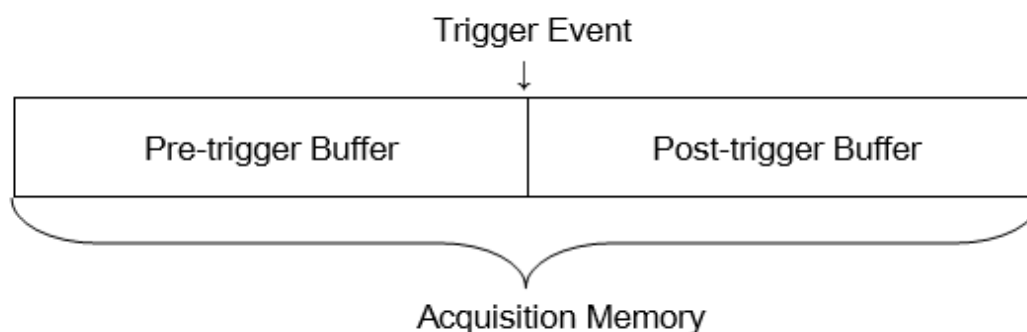

Trigger setting should be based on the features of the input signal, thus you need to have some knowledge of the signal under test to quickly capture the desired waveform.

The oscilloscope provides abundant advanced trigger functions which can help you to focus on the desired waveform details. These trigger types are edge, slope, pulse, video, window, interval, dropout, runt, pattern and serial trigger. This chapter will mainly introduce all these trigger functions which mentioned above in details and tell you how to set the trigger conditions to capture desired waveform.

The contents of this chapter:

- ◆ Trigger Source
- ◆ Trigger Mode
- ◆ Trigger Level
- ◆ Trigger Coupling
- ◆ Trigger Holdoff
- ◆ Noise Rejection
- ◆ Trigger Type

Trigger Source

The 2-channel oscilloscope's trigger source includes analog channels, **EXT**, **EXT/5** and **AC Line**. The 4-channel oscilloscope's trigger source includes analog channels and **AC Line**.

Press the **Setup** button on the front panel to enter the TRIGGER function menu; press the **Source** softkey and then turn the **Universal Knob** to select the desired trigger source.

The current trigger source is displayed at the upper right corner of the screen. Select channel with signal input as trigger source to obtain stable trigger.

Analog channel input:

Signals input from analog channels can all be used as the trigger source.

External trigger input:

External trigger source can be used to connect external trigger signal to the EXT TRIG channel when all of the four channels are sampling data. The trigger signal (such as external clock and signal of the circuit to be tested) will be connected to **EXT** and **EXT/5** trigger source via the **[EXT TRIG]** connector. **EXT/5** trigger source attenuates the signal by a factor of 5. It extends the trigger level. You can set the trigger condition within the range of trigger level (-8 div to +8 div).

AC line:

The trigger signal is obtained from the AC power input of the oscilloscope. This kind of signals can be used to display the relationship between signal (such as illuminating device) and power (power supply device). For example, it is mainly used in related measurement of the power industry to stably trigger the waveform output from the transformer of a transformer substation.

Note: to select stable channel waveform as the trigger source to stabilize the display.

Trigger Mode

The oscilloscope's trigger mode includes auto, normal and single. Trigger mode affects the way in which the oscilloscope searches for the trigger

After the oscilloscope starts running, the oscilloscope operates by first filling the pre-trigger buffer. It starts searching for a trigger after the pre-trigger buffer is filled and continues to flow data through this buffer while it searches for the trigger. While searching for the trigger, the oscilloscope overflows the pre-trigger buffer and the first data put into the buffer is first pushed out (First Input First Out, FIFO).

When a trigger is found, the pre- trigger buffer contains the events that occurred just before the trigger. Then, the oscilloscope fills the post- trigger buffer and displays the acquisition memory.

Press the **Auto**, **Normal** and the **Single** buttons on the front panel to select the desired trigger mode, and the corresponding status light will be lighted.

- In the **Auto** trigger mode (the default setting), if the specified trigger conditions are not found, triggers are forced and acquisitions are made so that signal activity is displayed on the oscilloscope.

The **Auto** trigger mode is appropriate when:

- Checking DC signals or signals with unknown levels or activity.
- When trigger conditions occur often enough that forced triggers are unnecessary.

- In the **Normal** trigger mode, triggers and acquisitions only occur when the specified trigger conditions are found. Otherwise, the oscilloscope holds the original waveform and waits for the next trigger.

The **Normal** trigger mode is appropriate when:

- You only want to acquire specific events specified by the trigger settings.
- Triggering on an infrequent signal from a serial bus (for example, I2C, SPI, CAN, LIN, etc.) or another signal that arrives in bursts. The **Normal** trigger mode lets you stabilize the display by preventing the oscilloscope from auto- triggering.

- In the **Single** trigger mode, the oscilloscope waits for a trigger and displays the waveform when the trigger condition is met and then stops.

The **Single** trigger mode is appropriate when:

- To capture single event or a periodic signal.
- To capture burst or other unusual signals.

Note: You can force the oscilloscope to trigger by pressing the **Single** button twice. The trigger status in the upper left corner of the screen will be displayed as "FStop".

Trigger Level

Trigger level and slope define the trigger point,

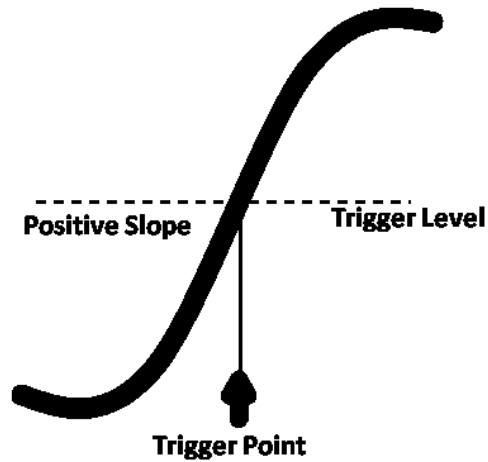

You can adjust the trigger level for a selected analog channel by turning the **Trigger Level Knob**.

You can push the **Trigger Level Knob** to set the level to the waveform's 50% value immediately. If AC coupling is used, pushing the **Trigger Level knob** sets the trigger level to about 0 V.

The position of the trigger level for the analog channel is indicated by the trigger level icon ◀ (if the analog channel is on) at the left side of the display. The value of the analog channel trigger level is displayed in the upper- right corner of the display.

Trigger Coupling

Press the Setup button on the front panel to enter the TRIGGER function menu, and then press the **Coupling** softkey and turn the **Universal Knob** or press the **Coupling** softkey continually to select the desired coupling mode.

The oscilloscope provides 4 kinds of trigger coupling modes:

- **DC:** allow DC and AC components into the trigger path.
- **AC:** block all the DC components and attenuate signals lower than 8 Hz. Use AC coupling to get a stable edge trigger when your waveform has a large DC offset.
- **LF Reject:** block the DC components and reject the low frequency components lower than 2 MHz. Low frequency reject removes any unwanted low frequency components from a trigger waveform, such as power line frequencies, etc. that can interfere with proper triggering. Use **LF Reject** coupling to get a stable edge trigger when your waveform has low frequency noise.
- **HF Reject:** reject the high frequency components higher 1.2 MHz)

Note: trigger coupling has nothing to do with the channel coupling.

Trigger Holdoff

Trigger holdoff can be used to stably trigger the complex waveforms (such as pulse series). Holdoff time is the amount of time that the oscilloscope waits before re-arming the trigger circuitry. The oscilloscope will not trigger until the holdoff time expires.

Use the holdoff to trigger on repetitive waveforms that have multiple edges (or other events) between waveform repetitions. You can also use holdoff to trigger on the first edge of a burst when you know the minimum time between bursts.

For example, to get a stable trigger on the repetitive pulse burst shown below, set the holdoff time to be >200 ns but <600 ns.

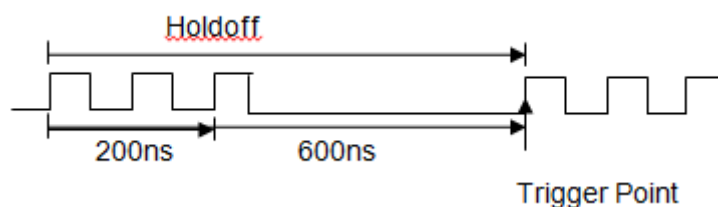

The correct holdoff setting is typically slightly less than one repetition of the waveform. Set the holdoff to this time to generate a unique trigger point for a repetitive waveform. Only edge trigger and serial trigger have holdoff option. The holdoff time of the oscilloscope is adjustable from 80ns to 1.5s.

1. Press the **Stop** button, and then use the **Horizontal Position Knob** and the **Horizontal Scale Knob** to find where the waveform repeats. Measure this time using cursors; then, set the holdoff.
2. Press the **Setup** button on the front panel to enter the TRIGGER function menu. The default trigger type is edge.
3. Press the **Holdoff Close** softkey; and then turn the **Universal Knob** to set the desired holdoff time.

Note: adjust the time scale and horizontal position will not affect the holdoff

Noise Rejection

Noise Reject adds additional hysteresis to the trigger circuitry. By increasing the trigger hysteresis band, you reduce the possibility of triggering on noise. However, this also decreases the trigger sensitivity so that a slightly larger signal is required to trigger the oscilloscope.

Press the **Setup** button on the front panel, and then press the **Noise Reject** softkey continually to set the option to **On** or **Off** to turn on or off the noise rejection function.

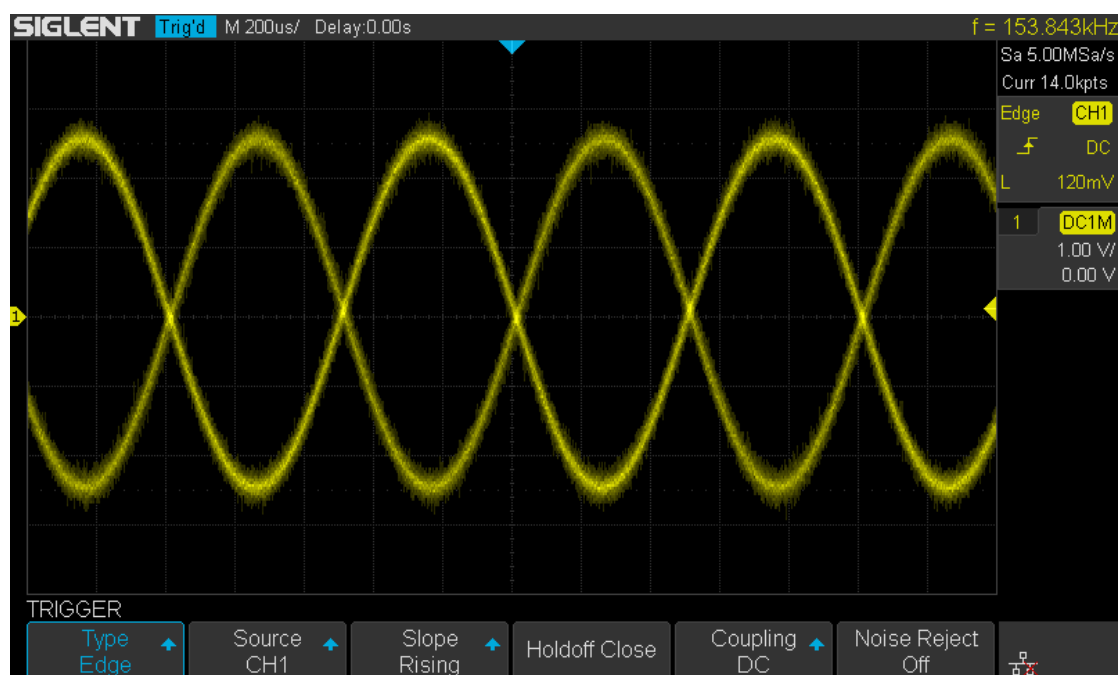

Figure 29 Turn off the Noise Reject



Figure 30 Turn on the Noise Reject

If the signal you are probing is noisy, you can set up the oscilloscope to reduce the noise in the trigger path and on the displayed waveform. First, stabilize the displayed waveform by removing the noise from the trigger path. Second, reduce the noise on the displayed waveform.

1. Connect a signal to the oscilloscope and obtain a stable display.
2. Remove the noise from the trigger path by setting trigger coupling to **LF Reject**, **HF Reject** or turning on **Noise Reject**.
3. Set the **Acquisition** option to Average to reduce noise on the displayed waveform.

Trigger Type

The oscilloscope provides abundant advanced trigger functions, including various serial bus triggers.

- ◆ Edge trigger
- ◆ Slope trigger
- ◆ Pulse trigger
- ◆ Video trigger
- ◆ Window trigger
- ◆ Interval trigger
- ◆ Dropout trigger
- ◆ Runt trigger
- ◆ Pattern trigger

Edge Trigger

Edge trigger distinguishes the trigger points by seeking the specified edge (rising, falling, alternating) and trigger level.

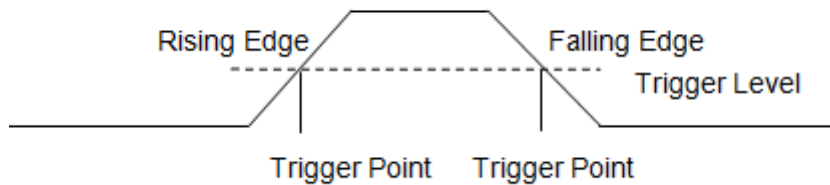

1. Press the **Setup** button on the front panel to enter the TRIGGER system function menu.
2. Press the **Type** softkey; turn the **Universal Knob** to set select **Edge** and then push the knob to confirm.
3. Press the **Source** softkey; turn the **Universal Knob** to select the deserted trigger source.
4. Press the **Slope** softkey; turn the **Universal Knob** to select the desired trigger edge (rising, falling or alternating), and then press down the knob to confirm. The current trigger slope is displayed at the upper right corner of the screen.
5. Turn the **Trigger Level Knob** to adjust the trigger level to obtain stable trigger.

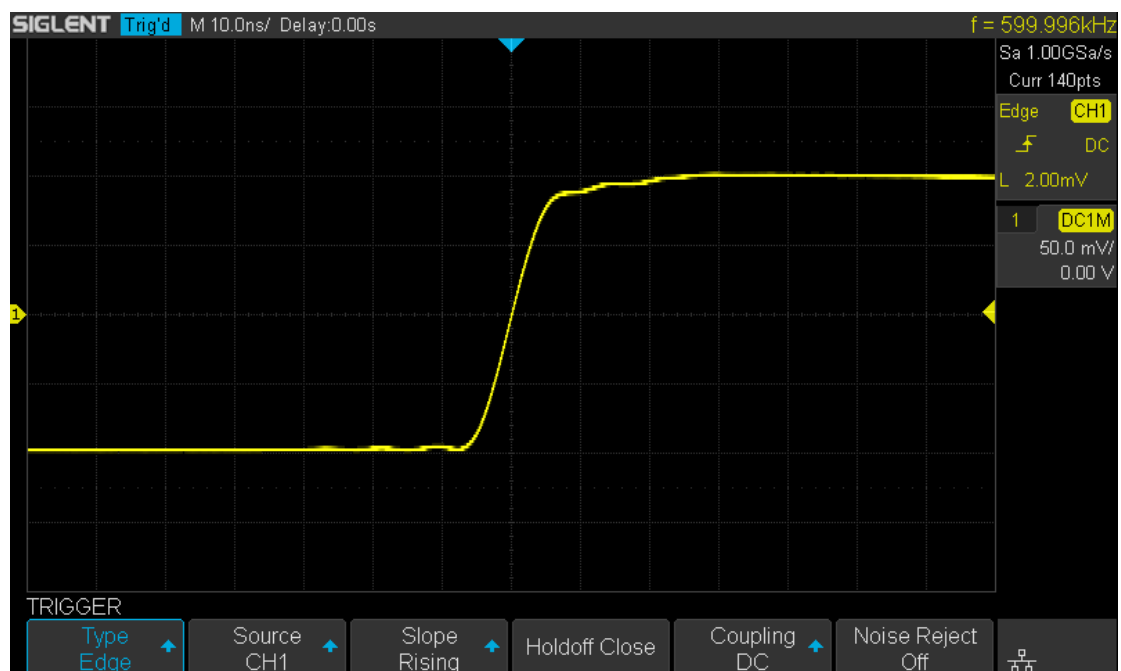

Figure 31 Edge Trigger

Holdoff, coupling and noise reject can be set in edge trigger, see the sections "Trigger Holdoff", "Trigger Coupling" and "Noise Rejection" for details.

Note: Press the **Auto Setup** button will set the trigger type to Edge and slope to rising.

Slope Trigger

The slope trigger looks for a rising or falling transition from one level to another level in greater than or less than a certain amount of time.

In the oscilloscope, positive slope time is defined as the time difference between the two crossing points of trigger level line A and B with the positive edge as shown in the figure below.

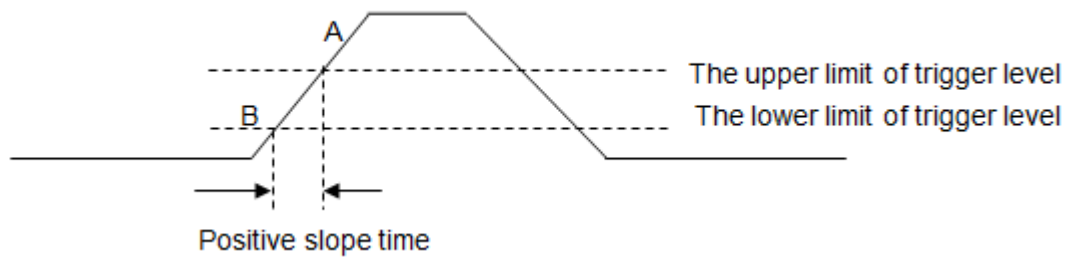

1. Press the **Setup** button on the front panel to enter the TRIGGER function menu.
2. Press the **Type** softkey; turn the **Universal Knob** to set select **Slope** and then push the knob to confirm.
3. Press the **Source** softkey; turn the **Universal Knob** to select the trigger source.
4. Press the **Slope** softkey; turn the **Universal Knob** to set select the desired trigger edge (rising or falling), and then push down the knob to confirm. The current trigger slope is displayed at the upper right corner of the screen.
5. Press **Lower Upper** softkey to select the **Lower** or **Upper** trigger level; then turn the **Trigger Level Knob** to adjust the position. The trigger level values are displayed at the upper right corner of the screen.

The lower trigger level cannot be upper than the upper trigger level. In the trigger state message box, L1 means the upper trigger lever while L2 means the lower trigger level.

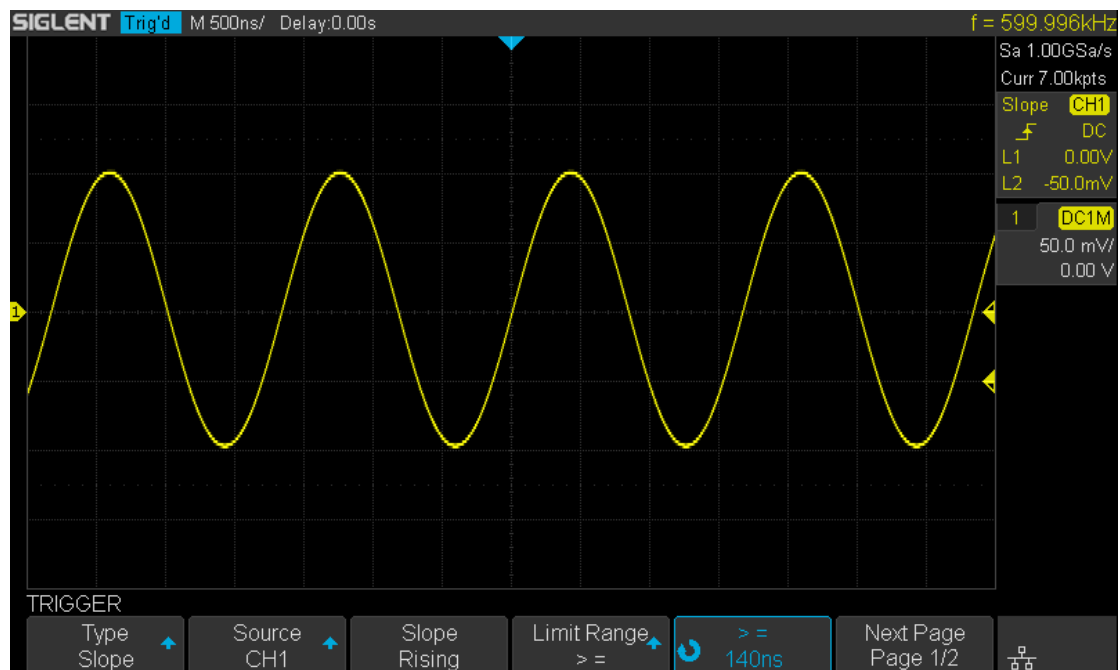

Figure 32 Slope Trigger

6. Press the **Limit Range** softkey; then turn the **Universal Knob** to select the desired slope condition, and push down the knob to confirm.
 - **<= (less than a time value)**: trigger when the positive or negative slope time of the input signal is lower than the specified time value.
 - **>= (greater than a time value)**: trigger when the positive or negative slope time of the input signal is greater than the specified time value.
 - **[--,--] (within a range of time value)**: trigger when the positive or negative slope time of the input signal is greater than the specified lower limit of time and lower than the specified upper limit of time value.
 - **--][-- (outside a range of time value)**: trigger when the positive or negative slope time of the input signal is greater than the specified upper limit of time and lower than the specified lower limit of time value.

Coupling and noise reject can be set in slope trigger, see the sections "**Trigger Coupling**" and "**Noise Rejection**" for details.

Pulse Trigger

Trigger on the positive or negative pulse with a specified width.

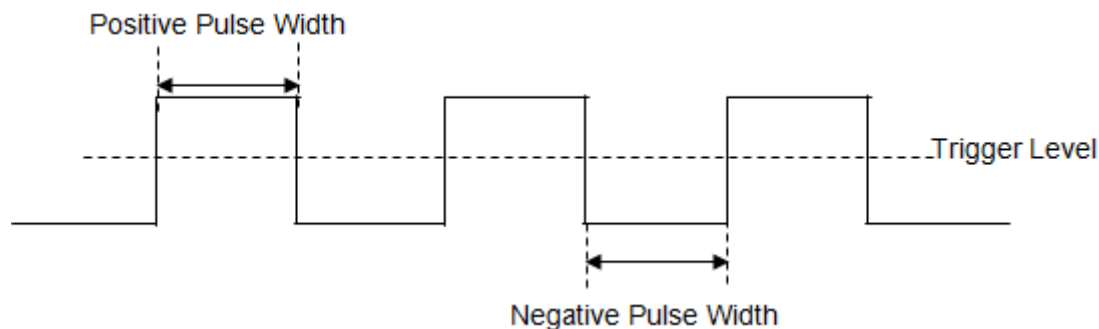

1. Press the **Setup** button on the front panel to enter the TRIGGER function menu.
2. Press the **Type** softkey; turn the **Universal Knob** to select **Pulse** and then push the knob to confirm.
3. Press the **Source** softkey; turn the **Universal Knob** to select CH1 or CH2 as the trigger source.
4. Turn the **Trigger Level Knob** to adjust the trigger level to the desired place.
5. Press the **Polarity** softkey to select **Positive** or **Negative** pulse that to trigger on. The current trigger polarity is displayed at the upper right corner of the screen.
6. Press the **Limit Range** softkey; turn the **Universal Knob** to select the desired condition.
 - **<= (less than a time value)**: trigger when the positive or negative pulse time of the input signal is lower than the specified time value. For example, for a positive pulse, if you set t (pulse real width) $\leq 100\text{ns}$, the waveform will trigger.



- **>= (greater than a time value)**: trigger when the positive or negative pulse time of the input signal is greater than the specified time value. For example, for a positive pulse, if you set t (pulse real width) $\geq 100\text{ns}$, the waveform will trigger.



- **[--,--] (within a range of time value)**: trigger when the positive or negative pulse time of the input signal is greater than the specified lower limit of time and lower than the specified upper limit of time value.

For example, for a positive pulse, if you set t (pulse real width) $\geq 100\text{ns}$ and $t \leq 300\text{ns}$, the waveform will trigger.

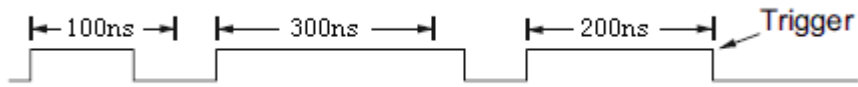

- **--][-- (outside a range of time value)**: trigger when the positive or negative pulse time of the input signal is greater than the specified upper limit of time and lower than the specified lower limit of time value.

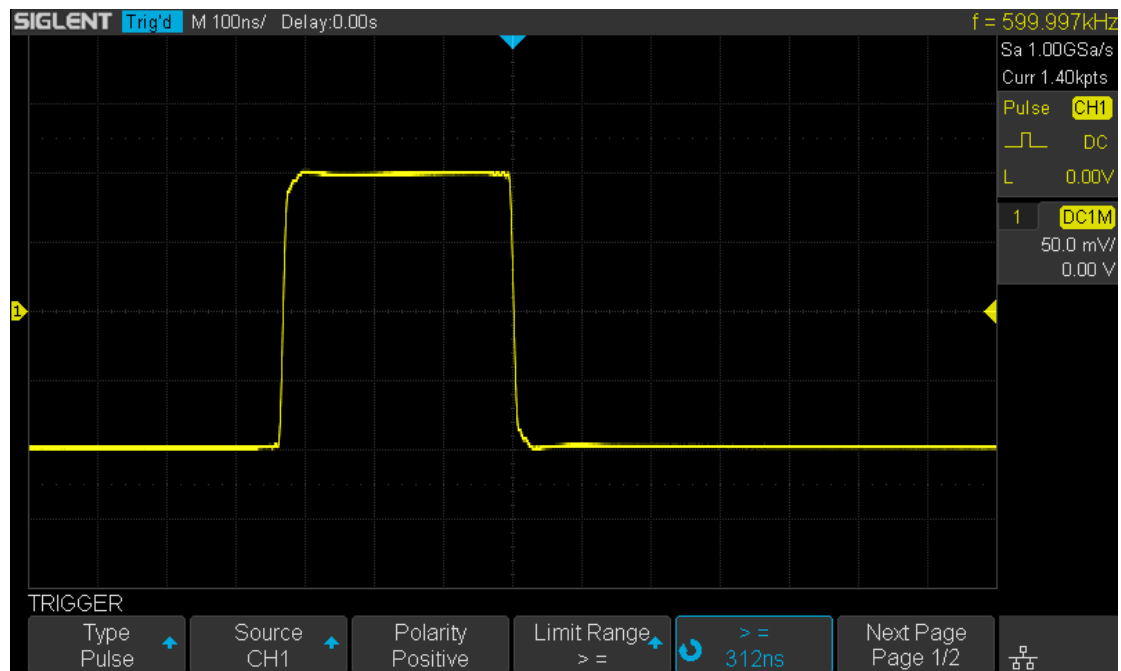

Figure 33 Pulse Trigger

Coupling and noise reject can be set in pulse trigger, see the sections "Trigger Coupling" and "Noise Rejection" for details.

Video Trigger

Video triggering can be used to capture the complicated waveforms of most standard analog video signals. The trigger circuitry detects the vertical and horizontal interval of the waveform and produces triggers based on the video trigger settings you have selected.

The oscilloscope supports standard video signal field or line of NTSC (National Television Standards Committee), PAL (Phase Alternating Line) HDTV (High Definition Television) and custom video signal trigger.

1. Press the **Setup** button on the front panel to enter the TRIGGER function menu.
2. Press the **Type** softkey; then turn the **Universal Knob** to select **Video** and push down the knob to confirm.
3. Press the **Source** softkey; turn the **Universal Knob** to select CH1 or CH2 as the trigger source. Turn the **Trigger Level Knob** does not change the trigger level because the trigger level is automatically set to the sync pulse.
4. Press the **Standard** softkey to select the desired video standard. The oscilloscope supports the following video standards.

Standard	Type	Sync Pulse
NTSC	Interlaced	BI-level
PAL	Interlaced	BI-level
HDTV 720P/50	Progressive	Tri-level
HDTV 720P/60	Progressive	Tri-level
HDTV 1080P/50	Progressive	Tri-level
HDTV 1080P/60	Progressive	Tri-level
HDTV 1080i/50	Progressive	Tri-level
HDTV 1080i/50	Progressive	Tri-level
Custom		

The table below shows the parameters of the Custom video trigger.

Frame Rate	25Hz, 30Hz, 50Hz, 60Hz	
Of Lines	300~2000	
Of Fields	1, 2, 3, 4	
Interlace	1:1, 2:1, 4:1, 8:1	
Trigger Position	Line	Field
	(line value)/1	1
	(line value)/2	2
	(line value)/3	3
	(line value)/4	4
	(line value)/5	5
	(line value)/6	6

	(line value)/7	7
	(line value)/8	8

The table below takes **Of Lines** as 800 as an example to explain the relation between **Of Lines, Of Fields, Interlace, Trigger Line** and **Trigger Field**.

Of Lines	Of Fields	Interlace	Trigger Line	Trigger Field
800	1	1:1	800	1
800	1,2,4 or 8	2:1	400	1, 1~2, 1~4, 1~8
800	1,2,4 or 8	4:1	200	1, 1~2, 1~4, 1~8
800	1,2,4 or 8	8:1	100	1, 1~2, 1~4, 1~8

- Press the **Sync** softkey to select **Any** or **Select** trigger mode.
 - Any**: trigger on any of the horizontal sync pulses
 - Select**: trigger on the appointed line and field you have set. Press the **Line** or **Field** softkey; then turn the **Universal Knob** to set the value.

The following table lists the line numbers per field for each video standard.

Standard	Field 1	Field 2
NTSC	1 to 262	1 to 263
PAL	1 to 312	1 to 313
HDTV 720P/50, HDTV 720P/60	1 to 750	
HDTV 1080P/50, HDTV 1080P/60	1 to 1125	
HDTV 1080iP/50, HDTV 1080i/60	1 to 562	1 to 563

The following are exercises to familiarize you with video triggering.

- To trigger on a specific line of video
- To use Custom video trigger

To Trigger on a Specific Line of Video

Video triggering requires greater than 1/2 division of sync amplitude with any analog channel as the trigger source.

The example below set to trigger on field 2, line 124 using the NTSC video standard.

- Press the **Setup** button on the front panel to enter the TRIGGER system function menu.
- Press the **Type** softkey; then use the **Universal Knob** to select Video and push down the knob to confirm.
- Press the **Source** softkey; turn the **Universal Knob** to select CH1 as the trigger source, and press the knob to confirm.
- Press the **Standard** softkey; turn the **Universal Knob** to select NTSC, and press the knob to confirm.
- Press the **Sync** softkey and set the option to **Select**; press the **Line** softkey and then turn the universal to select **022** and push the knob to confirm; press the

Field softkey and then turn the **Universal Knob** to select **1** and push the knob to confirm

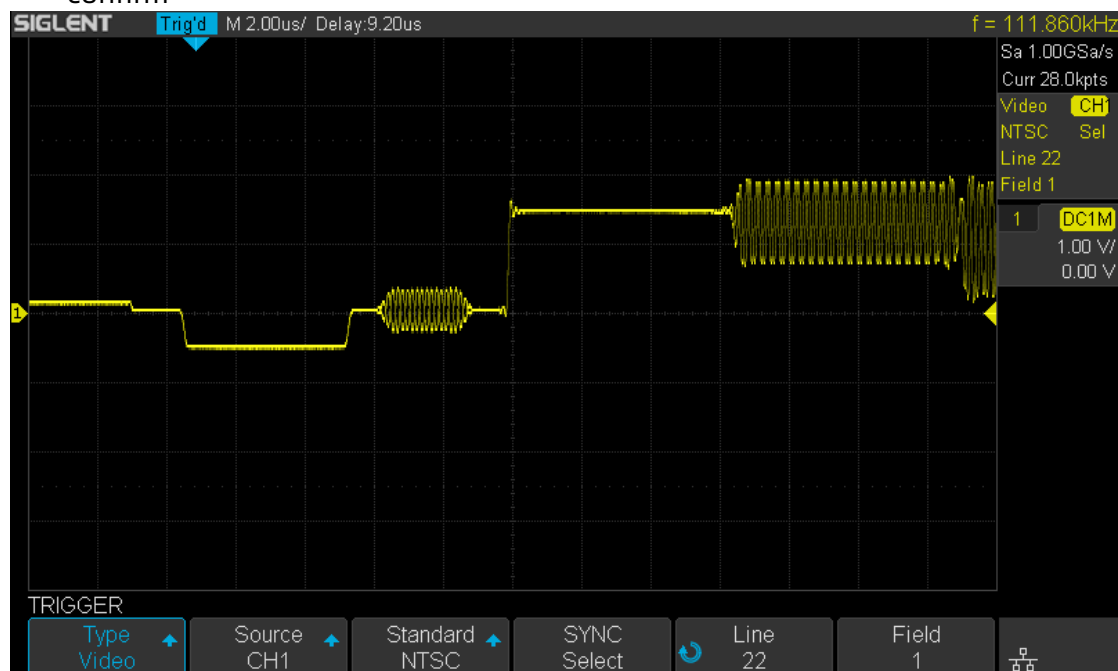

Figure 34 Video Trigger

To Use Custom Video Trigger

Custom video trigger supports frame rate of 25Hz, 30Hz, 50Hz and 60Hz, and the line range is available from 300 to 2000. The steps below show how to set custom trigger.

1. Press the **Setup** button on the front panel to enter the TRIGGER function menu.
2. Press the **Type** softkey; then use the **Universal Knob** to select **Video** and push down the knob to confirm.
3. Press the **Source** softkey; turn the **Universal Knob** to select **CH1** as the trigger source, and push down the knob to confirm.
4. Press the **Standard** softkey; turn the **Universal Knob** to select **Custom**, and push down the knob to confirm.
5. Press the **Setting** softkey to enter the custom setting function menu. Press the **Interlace** softkey; turn the **Universal Knob** to select the desired value.
6. Press the **Of Field** softkey; turn the **Universal Knob** to select the desired value.
7. Press the **Sync** softkey to enter the TRIG ON menu to set the line and field.
 - Press the **Type** softkey to select **Select** or **Any**.
 - If the **Type** option set to **Select**, press the **Line** softkey; turn the **Universal Knob** to select the desired value. Press the **Field** softkey; turn the **Universal Knob** to select the desired value.

Window Trigger

Windows trigger provides a high trigger level and a low trigger level. The instrument triggers when the input signal passes through the high trigger level or the low trigger level.

There are two kinds of window types: Absolute and Relative. They have different trigger level adjustment methods. Under Absolute window type, the lower and the upper trigger levels can be adjusted respectively via the Level knob; under Relative window type, adjust the Center value to set the window center; adjust the Delta value to set the window range, the lower and the upper trigger levels always move together.

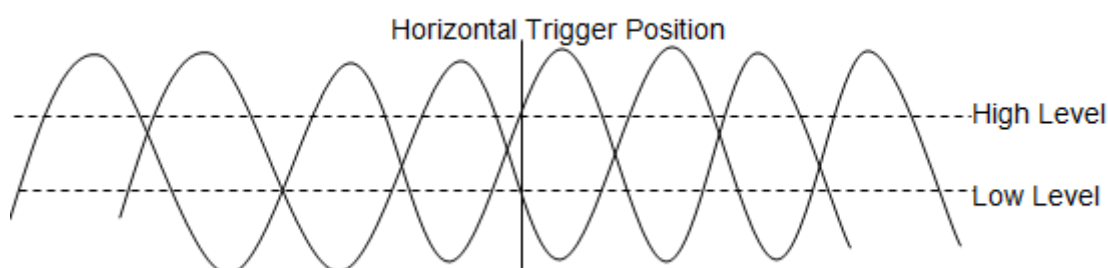

- If the lower and the upper trigger levels are both within the waveform amplitude range, the oscilloscope will trigger on both rising and falling edge.
- If the upper trigger level is within the waveform amplitude range while the lower trigger level is out of the waveform amplitude range, the oscilloscope will trigger on rising edge only.
- If the lower trigger level is within the waveform amplitude range while the upper trigger level is out of the waveform amplitude range, the oscilloscope will trigger on falling edge only.

To set window trigger via Absolute window type:

1. Press the **Setup** button on the front panel to enter the TRIGGER function menu.
2. Press the **Type** softkey; then use the **Universal Knob** to select **Window** and push down the knob to confirm.
3. Press the **Source** softkey; turn the **Universal Knob** to select CH1 or CH2 as the trigger source.
4. Press the **Window Type** softkey to select Absolute.
5. Press the **Lower Upper** softkey to select **Lower** or **Upper** trigger level; then turn the **Trigger Level Knob** to adjust the position. The trigger level values are displayed at the upper right corner of the screen.

The Lower trigger level cannot be upper than the upper trigger level. In the trigger state message box, **L1** means the upper trigger level while **L2** means the lower trigger level.

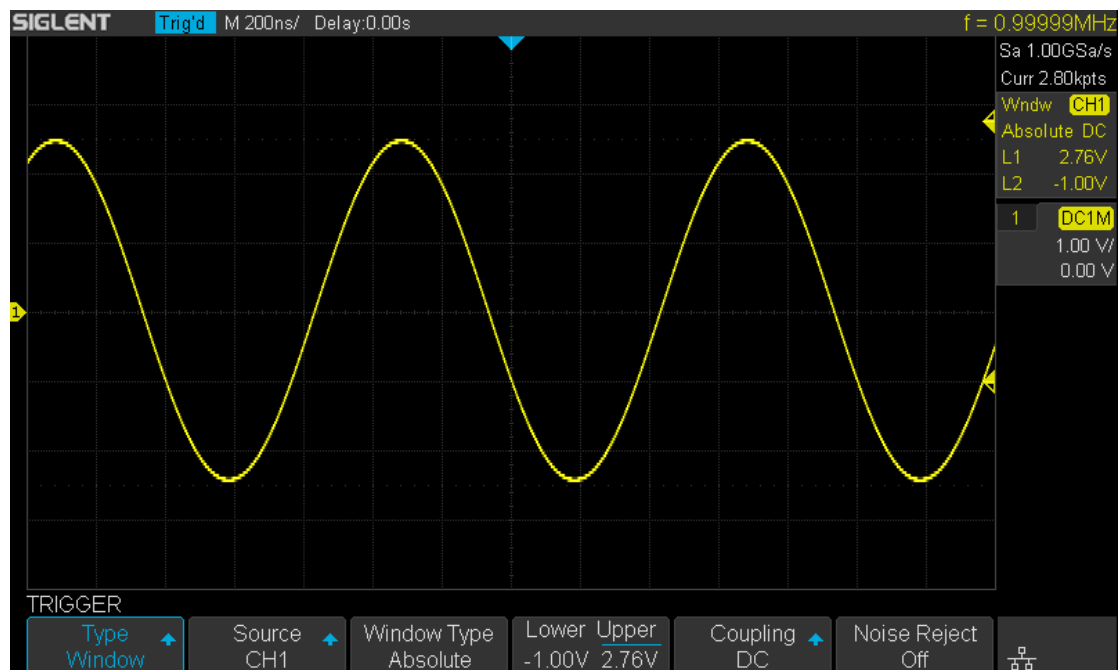

Figure 35 Absolute Window Trigger

To set window trigger via Relative window type:

1. Press the **Setup** button on the front panel to enter the TRIGGER system function menu.
2. Press the **Type** softkey; then use the **Universal Knob** to select **Window** and push down the knob to confirm.
3. Press the **Source** softkey; turn the **Universal Knob** to select CH1 or CH2 as the trigger source.
4. Press the **Window Type** softkey to select **Relative**.
5. Press the **Center Delta** softkey to select **Center** or **Delta** trigger level mode; then turn the **Trigger Level Knob** to adjust the position. The **Center** and **Delta** values are displayed at the upper right corner of the screen.
6. In the trigger state message box, **C** means **Center**, the center value of the lower and upper trigger levels; **D** means **Delta**, the difference between the lower (or upper) trigger level and the trigger level center.

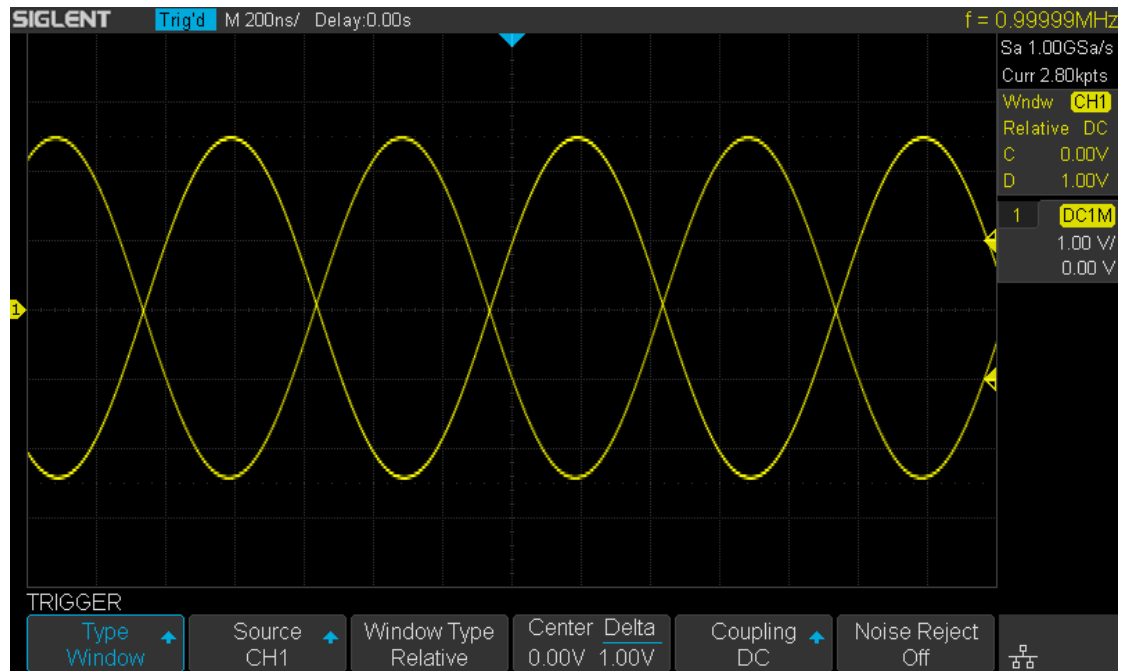
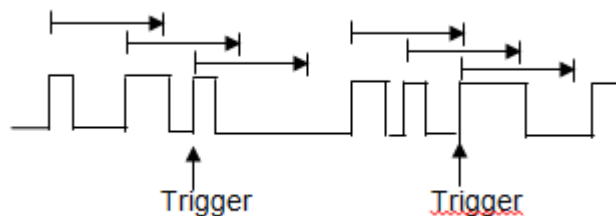

Figure 36 Relative Window Trigger

Coupling and noise reject can be set in Window trigger, see the sections "**Trigger Coupling**" and "**Noise Rejection**" for details.

Interval Trigger

Trigger when the times difference between the neighboring rising or falling edges meets the time limit (\leq , \geq , [--,--], --][--).



To set interval trigger:

1. Press the **Setup** button on the front panel to enter the TRIGGER system function menu.
2. Press the **Type** softkey; then use the **Universal Knob** to select **Interval** and push down the knob to confirm.
3. Press the **Source** softkey; turn the **Universal Knob** to select CH1 or CH2 as the trigger source.
4. Press the **Slope** softkey to select rising or falling edge.
5. Press the **Limit Range** softkey; turn the **Universal Knob** to select desired condition.
 - **\leq (less than a time value)**: trigger when the positive or negative pulse time of the input signal is lower than the specified time value.
 - **\geq (greater than a time value)**: trigger when the positive or negative pulse time of the input signal is greater than the specified time value.
 - **[--,--] (within a range of time value)**: trigger when the positive or negative pulse time of the input signal is greater than the specified lower limit of time and lower than the specified upper limit of time value.
 - **--][-- (outside a range of time value)**: trigger when the positive or negative pulse time of the input signal is greater than the specified upper limit of time and lower than the specified lower limit of time value.
6. Press the **Time Setting** softkey (\leq , \geq , [--,--],--][--), turn the **Universal Knob** to select the desired value.

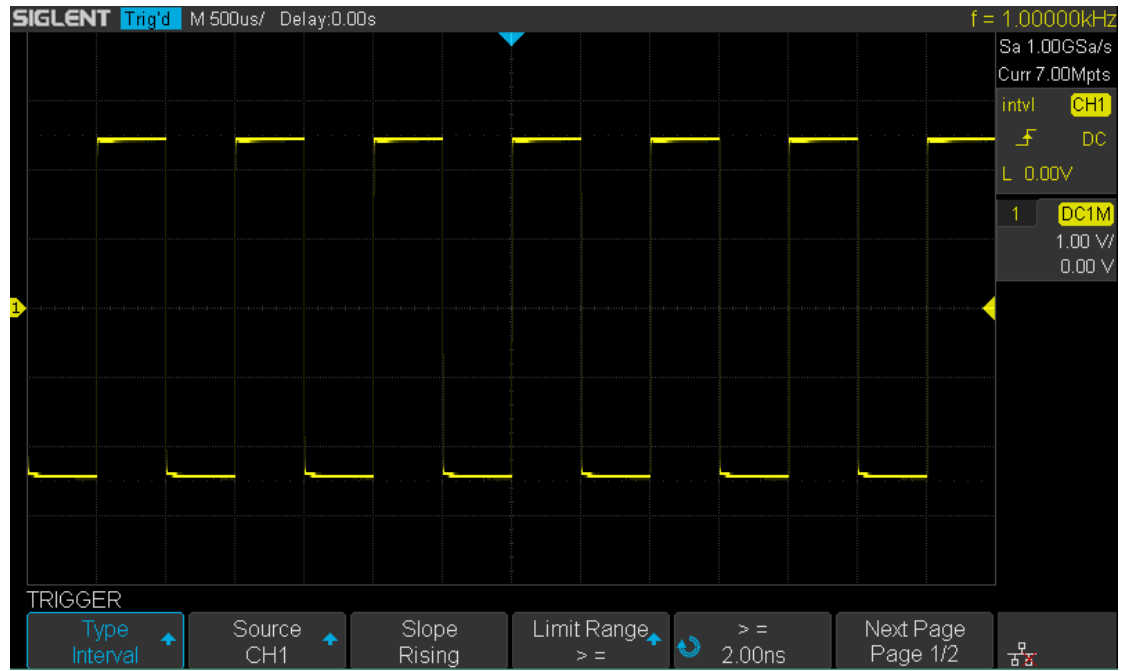

Figure 37 Interval Trigger

Coupling and noise reject can be set in interval trigger, see the sections "**Trigger Coupling**" and "**Noise Rejection**" for details.

Dropout Trigger

Dropout trigger includes two types: edge and state.

Edge

Trigger when the time interval (ΔT) from when the rising edge (or falling edge) of the input signal passes through the trigger level to when the neighboring rising edge (or falling edge) passes through the trigger level is greater than the timeout time set, as shown in the figure below.

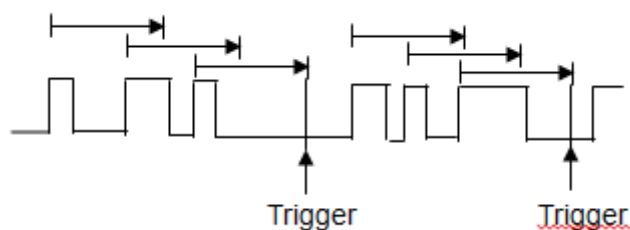

State

Trigger when the time interval (ΔT) from when the rising edge (or falling edge) of the input signal passes through the trigger level to when the neighboring falling edge (or rising edge) passes through the trigger level is greater than the timeout time set, as shown in the figure below.

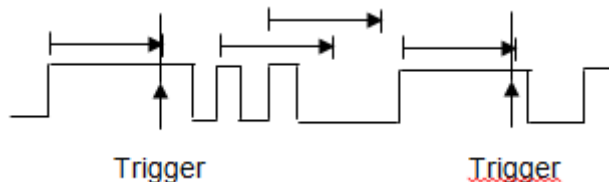

To set edge Dropout trigger:

1. Press the **Setup** button on the front panel to enter the TRIGGER system function menu.
2. Press the **Type** softkey; then use the **Universal Knob** to select **Dropout** and push down the knob to confirm.
3. Press the **Source** softkey; turn the **Universal Knob** to select CH1 or CH2 as the trigger source. The current trigger source is displayed at the upper right corner of the screen. Select channel with signal input as trigger source to obtain stable trigger.
4. Press the **Slope** softkey to select rising or falling edge.
5. Press the **OverTime Type** softkey to select **Edge**.
6. Press the **Time** softkey; turn the universal to select the desired value.



Figure 38 Edge Dropout Trigger

To set state Dropout trigger:

1. Press the **Setup** button to enter the TRIGGER system function menu.
2. Press the **Type** softkey; then turn the **Universal Knob** to select **Dropout** and push down the knob to confirm.
3. Press the **Source** softkey; turn the **Universal Knob** to select CH1 or CH2 as the trigger source.
4. Press the **Slope** softkey to select rising or falling edge.
5. Press the **OverTime** Type softkey to select State.
6. Press the **Time** softkey; turn the **Universal Knob** to select the desired value.

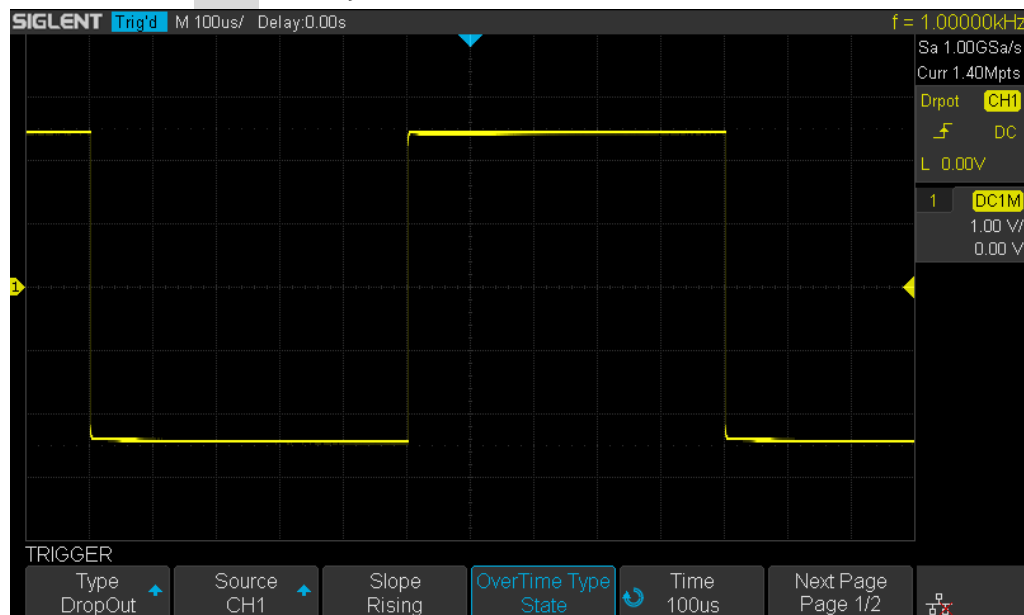
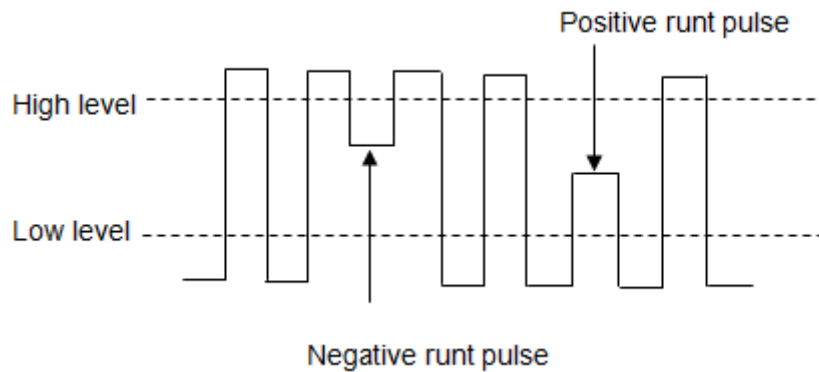

Figure 39 State Dropout Trigger

Coupling and noise reject can be set in dropout trigger, see the sections "**Trigger Coupling**" and "**Noise Rejection**" for details.

Runt Trigger

The Runt trigger looks for pulses that cross one threshold but not another as shown in the picture below.



- A positive runt pulse across through a lower threshold but not an upper threshold.
- A negative runt pulse across through an upper threshold but not a lower threshold.

To trigger on runt pulse:

1. Press the **Setup** button on the front panel to enter the **TRIGGER** system function menu.
2. Press the **Type** softkey; then turn the **Universal Knob** to select **Runt** and push down the knob to confirm.
3. Press the **Source** softkey; turn the **Universal Knob** to select CH1 or CH2 as the trigger source.
4. Press the **Polarity** softkey to select **Positive** or **Negative** pulse to trigger.
5. Press the **Limit Range** softkey; turn the **Universal Knob** to select the desired condition (\leq , \geq , $[-, -]$ or $--][--]$).
6. Press the **Time Setting** softkey, and then turn the **Universal Knob** to select the desired value.
7. Press the **Next Page** softkey to enter the second page of the TRIGGER system function menu. Press the **Lower Upper** softkey to select **Lower** or **Upper** trigger level, and then turn the **Universal Knob** to set the position.

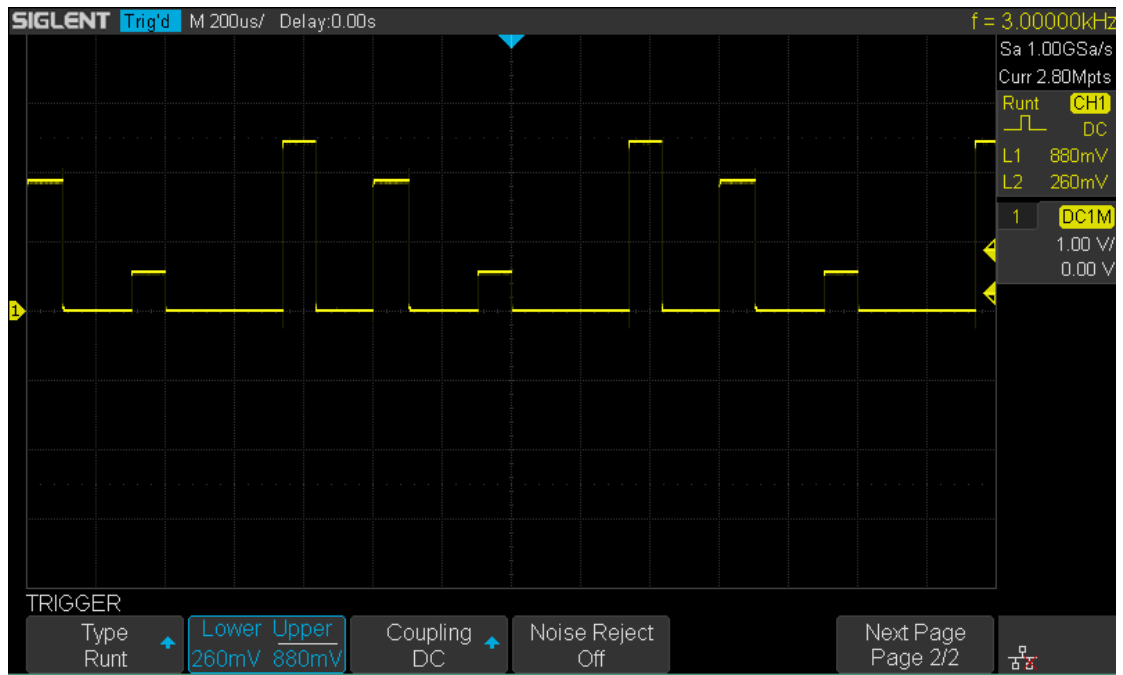
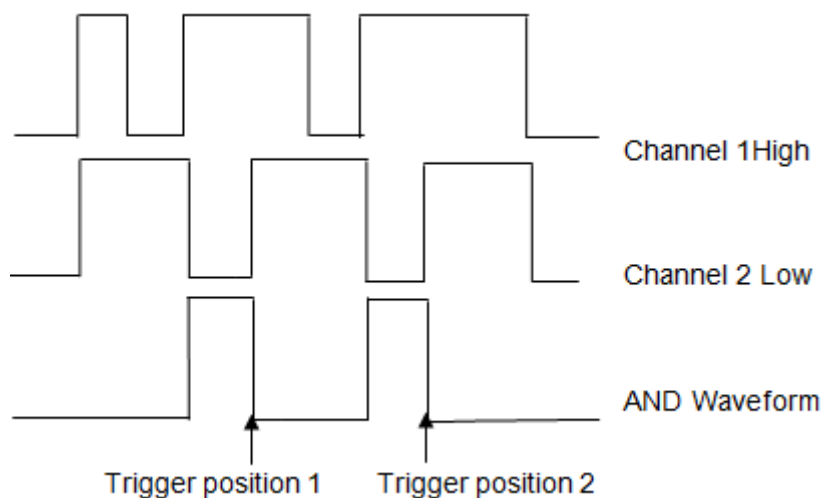

Figure 40 Runt Trigger

Coupling and noise reject can be set in runt trigger, see the sections "**Trigger Coupling**" and "**Noise Rejection**" for details.

Pattern Trigger

The Pattern trigger identifies a trigger condition by looking for a specified pattern. The pattern trigger can be expanded to incorporate delays similar to other triggers. Pattern durations are evaluated using a timer. The timer starts on the last edge that makes the pattern "true". Potential triggers occur on the first edge that makes the pattern false, provided that the time qualifier criterion has been met. The oscilloscope provides 4 patterns: logical AND, OR, NAND and NOR combination of the channels. Each channel can set to low, high or invalid.



Do the following steps to set pattern trigger:

1. Press the **Setup** button on the front panel to enter the TRIGGER function menu.
2. Press the **Type** softkey; turn the **Universal Knob** to select **Pattern**, and then push down the knob to confirm.
3. Press each channel softkey to select **Invalid, High or Low**.
 - **Low** sets the pattern to low on the selected channel. A low is a voltage level that is less than the channel's trigger level or threshold level.
 - **High** sets the pattern to high on the selected channel. A high is a voltage level that is greater than the channel's trigger level or threshold level.
 - **Don't care** sets the pattern to don't care on the selected channel. Any channel set to don't care is ignored and is not used as part of the pattern.
 - However, if all channels in the pattern are set to **Don't care**, the oscilloscope will not trigger.

Adjust the trigger level for the selected analog channel by turning the Trigger Level knob. **Don't care** doesn't need to set trigger level.
4. Press the **Next Page** softkey to enter the second page of the pattern trigger menu.

5. Press the **Logic** softkey and then turn the **Universal Knob** to select the desired logic combination **AND**, **OR**, **NAND** or **NOR**.
6. Press the **Time** softkey; then turn the **Universal Knob** to select the desired time value.
7. Press the **Holdoff Close** softkey to turn on the Holdoff function; then turn the **Universal Knob** to select the desired value.

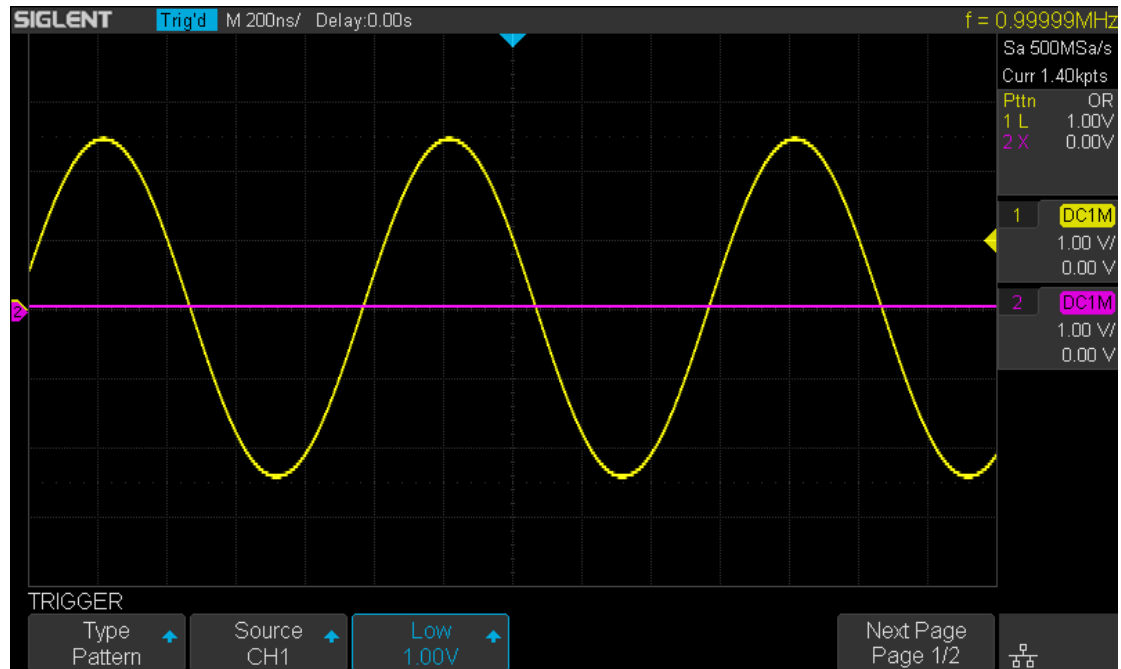

Figure 41 Pattern Trigger

Holdoff can be set in pattern trigger, see the sections "**Trigger Holdoff**" for details.

Serial Trigger and Decode

The oscilloscope provides I2C, SPI, UART, CAN and LIN serial trigger and decode. This chapter introduces the method of triggering and decoding these serial signals in details.

The contents of this chapter:

- ◆ I2C Trigger and Decode
- ◆ SPI Trigger and Decode
- ◆ UART Trigger and Decode
- ◆ CAN Trigger and Decode
- ◆ LIN Trigger and Decode

I2C Trigger and Serial Decode

Please in order of “Setup for I2C Signals” , “I2C Trigger” and “I2C Serial Decode” to trigger and decode the signals.

Setup for I2C Signals

Setting the I2C (Inter-IC bus) signal includes two steps: connecting the serial data signal (SDA) and serial clock signal (SCK) to oscilloscope, specifying the threshold voltage of each input signal.

1. Press the **Decode** key to enter the **DECODE** function menu as Figure 42 shows.



Figure 42 I2C DECODE Menu

2. Press the **Decode** softkey and select the desired slot (Decode1 or Decode2).
3. Press the **Protocol** softkey and then select **I2C** by turning Universal Knob.
4. Press the **Signal** softkey to enter the **SIGNAL** menu as Figure 43 shows.



Figure 43 I2C SIGNAL Menu

5. Set SCL (I2C's clock signal):
 - a. Press the **SCL** softkey to select the channel that is connected to the I2C clock signal.
 - b. Press the first **Threshold** softkey to set the I2C clock signal's threshold voltage level by **Universal Knob**. The threshold voltage level is for decoding, and it will be regard as the trigger voltage level when set the trigger type to serial.
6. Set SDA (I2C's data signal):
 - a. Press the **SDA** to select the channel that is connected to the I2C data signal.
 - b. Press the second **Threshold** softkey to set the I2C data signal's threshold voltage level by **Universal Knob**. The threshold voltage level is for decoding, and it will be regard as the trigger voltage level when set the trigger type to serial.

(Tips: SDA should keep stable during the whole high clock cycle, otherwise it will be interpreted as a start or stop condition (data transitioning while the clock is high))
7. Press the **Back** softkey to return previous menu.

I2C Trigger

This part introduces the nine kinds of trigger conditions (Start, Stop, Restart, No Ack, EEPROM, 7 Addr&Data, 10 Addr&Data and Data Length) and the methods of setting them.

Trigger Conditions

- **Start Condition**— the oscilloscope will be triggered when SDA signal transitions from high to low while the SCL clock is high. If it is chosen as the condition of trigger (including frame triggers), a restart will be treated as a “Start condition” .
- **Stop Condition**— the oscilloscope will be triggered when SDA transitions from low to high while the SCL is high.

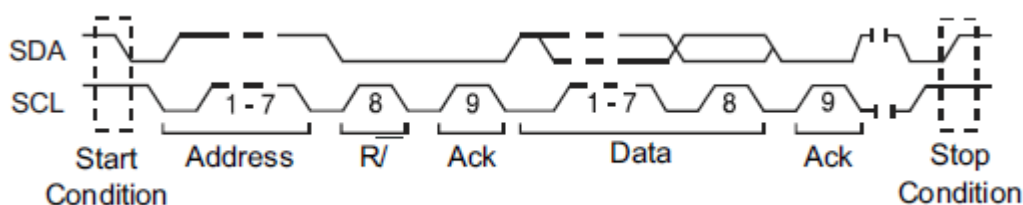

- **Restart**— the oscilloscope will be triggered when another “Start condition” occurs before a “Stop condition” .
- **No Ack**— the oscilloscope will be triggered when SDA data is high during any SCL’s ACK bit.
- **EEPROM** — the trigger searches for EEPROM control byte (the value is 1010xxx) on the SDA bus. And there is a Read bit and an ACK bit behind EEPROM. Using **Limit Range** softkey to set the qualifier and **Data1** softkey to set the data’s value. If EEPROM’s data is greater(less, equal) than Data1, the oscilloscope will be triggered at the edge of ACK bit behind Data byte. It’s unnecessary that the Data byte must follow the EEPROM.

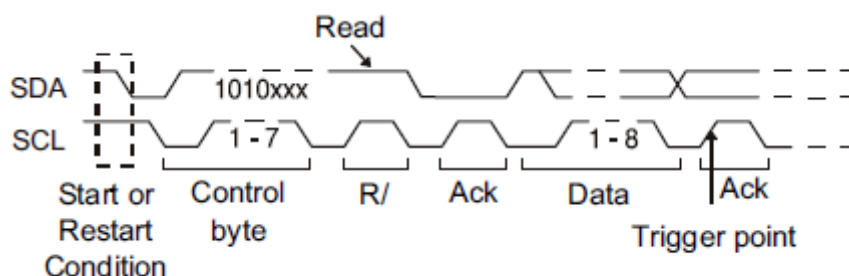

- **7 Address & Data** — the oscilloscope will be triggered when the following conditions are satisfied.
 - The address’s length must be 7 bits and the address’s value is the same as

set value.

- If you have set either Data1's or Data2's value, and the signal has a data is the same as that value. If you have set both Data1's and Data2's value, the signal should has two consecutive data, the first data's value is Data1, second data value is Data2.

(Note: If the data's value is 0xXX, any data value will be matched)

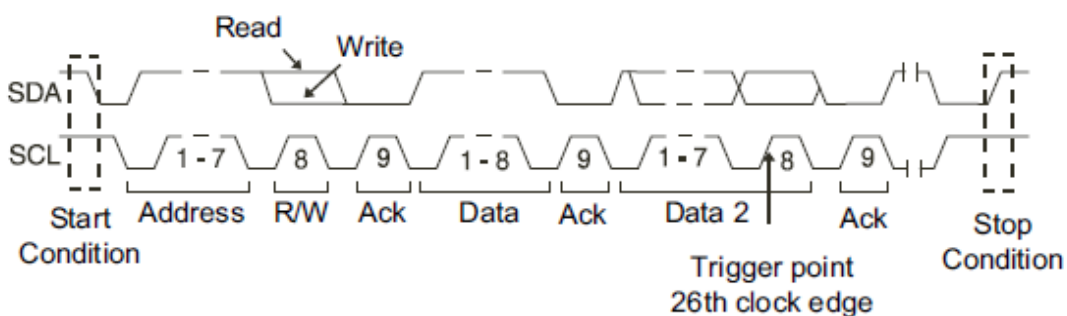
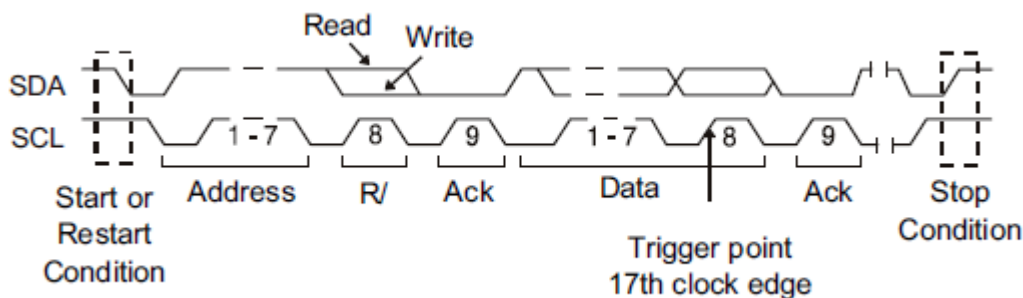

- **10 Address & Data** — the oscilloscope will be triggered when the following conditions are satisfied.
 - The address's length must be 10 bits and the address's value is the same as set value.
 - If you have set either Data1's or Data2's value, and the signal has a data is the same as that value. If you have set both Data1's and Data2's value, the signal should has two consecutive data, the first data's value is Data1, second data value is Data2.
- (Note: If the set value is 0xXX, any data value will be matched)

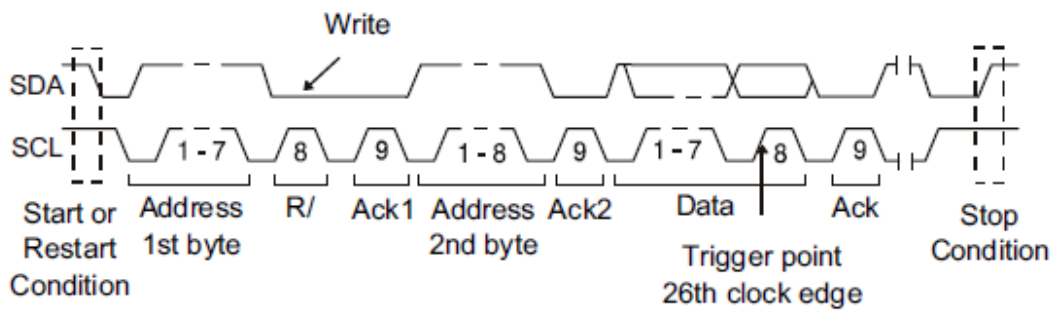

- **Data Length** — When SDA data's length is equal to the value of Byte Length and address's length is the same as set value, the oscilloscope will be triggered. Byte length is in the range of 1 to 12 bits.

Operation Steps

1. Press the **Setup** to enter the **TRIGGER** function menu.
2. Press the **Type** and select **Serial**.
3. Press the **Protocol** and select **I2C**.
4. Press the **Trigger Setting** softkey.

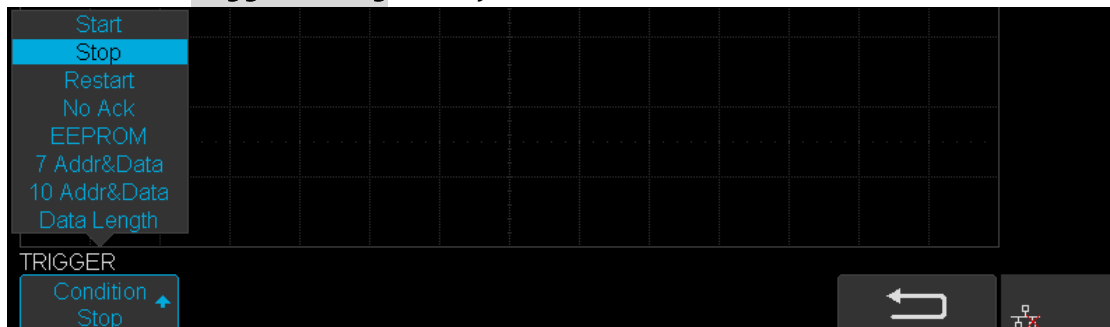

Figure 44 I2C TRIGGER Menu

5. Press the **Condition** softkey and turn the **Universal Knob** to select the trigger condition:
 - If you select the **EEPROM** condition:
 - a. Press the **Limit Range** softkey to set the qualifier (=, < or >).
 - b. Press the **Data1** softkey and set its value by turning the **Universal Knob**.
 - If you select **7 Addr & Data** or **10 Addr & Data** condition:
 - a. Press the **Addr** softkey and turn the **Universal Knob** to select the 7- bit or 10- bit device address.
 - b. Press the **Data1** or **Data2** softkey and set the value about them.
 - c. Press the **R/W bit** softkey and select write-frame or read-frame to

trigger the oscilloscope.

(**Tips:** If device address is 7-bit, the value of address is in range of 0x00 to 0x7F. If device's address is 10-bit, the value of address is in range of 0x00 to 0x3FF.)

- If you select the **Data Length** condition:
 - a. Press the **Address** to set the SDA address length 7bit or 10 bit.
 - b. Press the **Byte Length** softkey and set the byte length by **Universal Knob**. The range of the Byte Length is 1 to 12.

I2C Serial Decode

After completing the setup of I2C signal and trigger, we will decode I2C signals. Operation steps as follows.

1. Press **Decode** → **Decode**. Select one of the options from the **Decode1** and **Decode2**.
2. Press the **Display** and select **On** to display the result of decoding.
3. Press the **Configure** to turn on or off the read or write bit.
4. Press the **List** to enter the **LIST** function menu.
 - Press the **Display** and choose the same options as the first step.
 - Press the **Scroll** and turn the **Universal Knob** to view all frames.
 - Press the **Lines** and set the number of lines by **Universal Knob**. The range of the lines is 1 to 7.
 - When a packet of data is long, all decoded data are not displayed. Turn on the **Long Data** to display the complete data.
 - Users can export the result list of the package to the external USB storage device in csv format (only when the USB flash disk is detected). Saving the data (*.csv) is similar to the operation of setup files, see the section "**External save and recall**" for details.
5. Press the **Format** to change the character encoding format of the decoding's result.
6. Press the **Copy Setting** to enter the **COPY** function menu to synchronize the corresponding bus configuration and trigger configuration.
7. Press the **Tips Info** to turn on or off the decoding limit prompt. When the decoding frame number reaches the maximum, it will pop up "Decoding to maximum frame number limitation!"

Interpreting I2C Decode

The frames of decoding result:

- The address value is displayed at the beginning of a frame. The write address is displayed in green, and read address in yellow.
- W/R bit is represented by (W) and (R), following the address value.
- The data value is displayed in white.
- "~A" after a data or address bits indicates no acknowledgement. For example, DB~A.
-  Indicates there is not enough space on the display to show the complete content of a frame, and some content is hidden.

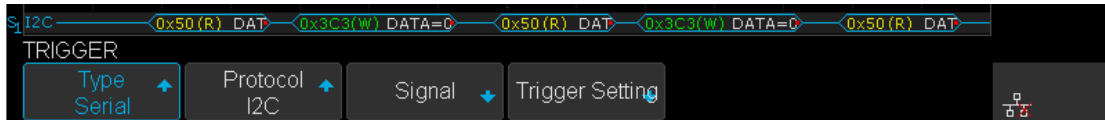

Figure 45 I2C Decode Bus Display

The lists of decoding result:

- Time — the horizontal displacement between current frame and trigger position.
- Address — the address of a frame.
- R/W — the type of a frame (write or read).
- Data — the value of data.

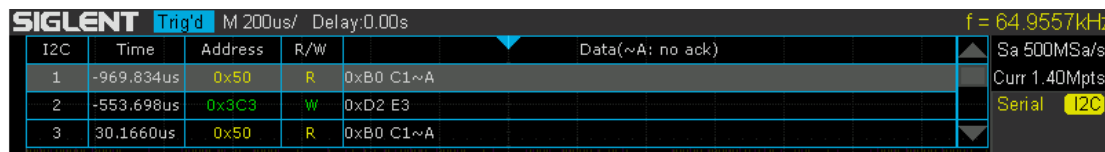

Figure 46 I2C Decode List Display

SPI Trigger and Serial Decode

Please in order of “Setup for SPI Signals” , “SPI Trigger” and “SPI Serial Decode” to trigger and decode the signals.

Setup for SPI Signals

Setting the SPI (Serial Peripheral Interface) signal includes two steps: connecting the CLK, MISO, MOSI and CS signals to oscilloscope; specifying the parameters of each input signal.

1. Press the **Decode** key to enter the **DECODE** function menu.
2. Press the **Decode** softkey and select the desired slot (Decode1 or Decode2).
3. Press the **Protocol** softkey and then select **SPI** by turning **Universal Knob**.
4. Press the **Signal** softkey to enter the **SIGNAL** menu as Figure 47 shows.



Figure 47 SPI SINGAL Menu

5. Set CLK (clock signal):
 - a. Press the **CLK** softkey to enter **CLK** menu.
 - b. Press the **CLK** softkey to select the channel that is connected to the SPI clock signal.
 - c. Press the **Threshold** softkey to set the SPI clock signal's threshold voltage level by **Universal Knob**. The threshold voltage level is for decoding, and it will be regard as the trigger voltage level when set the trigger type to serial.
 - d. Press the **Edge Select** softkey to set the oscilloscope will samples at clock signal's rising edge or falling edge.
 - e. Press the **Return** softkey to return previous menu.

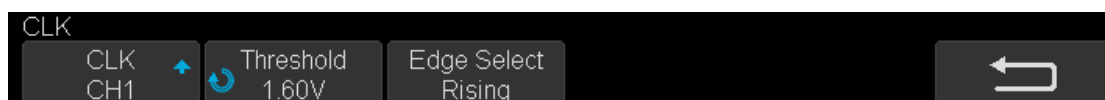

Figure 48 SPI CLK Menu

6. Set MISO:
 - a. Press the **MISO** softkey to enter the MISO menu.
 - b. Press the **MISO** softkey to select the channel that is connected to the SPI MISO signal.
 - c. Press the **Threshold** softkey to set the SPI MISO signal's threshold voltage

level by **Universal Knob**. The threshold voltage level is for decoding, and it will be regard as the trigger voltage level when set the trigger type to serial.

- d. Press the  softkey to return previous menu.



Figure 49 MISO Menu



- 7. Set MOSI:
 - a. Press the **MOSI** softkey to enter the MOSI menu.
 - b. Press the **MOSI** softkey to select the channel that is connected to the SPI MOSI signal.
 - c. Press the **Threshold** softkey to set the SPI MOSI signal's threshold voltage level by **Universal Knob**. The threshold voltage level is for decoding, and it will be regard as the trigger voltage level when set the trigger type to serial.
 - d. Press the  softkey to return previous menu.



Figure 50 MOSI Menu

- 8. Set CS:
 - a. Press the **CS** softkey to enter the MOSI menu.
 - b. Press the **Cs Type** softkey to select the chip select type.
 - c. Modify the Cs type's value.
 - d. Press the  softkey to return previous menu.

Function Menu	Settings	Explanation
CS Type	~CS	low voltage level of CS signal is available
	CS	high voltage level of CS signal is available
	CLK Timeout	<p>If the time between two edges of clock signal is less than (or equal to) the value of timeout, the signal between the two edges is treat as a frame. The range of clock timeout is 100ns-5ms.</p> <p>This setting is suitable for case where CS signal is not connected, or the number of oscilloscope channels is insufficient (such as 2-channel oscilloscopes).</p>

Table 1 Menu Explanations of the CS Type Parameters

Example:

Connect the data, CLK and \sim CS signals of a SPI bus respectively to C1, C2 and C3. Data width = 8-bit, Bit order = MSB, CS polarity = \sim CS, and 12 data bytes are transmitted in one frame.

In the SPI trigger signal menu, set the source and threshold of CLK, MISO and CS signals, then copy the trigger settings to decoding. Adjust the timebase, so that there is a falling edge on CS signal shown in the screen:

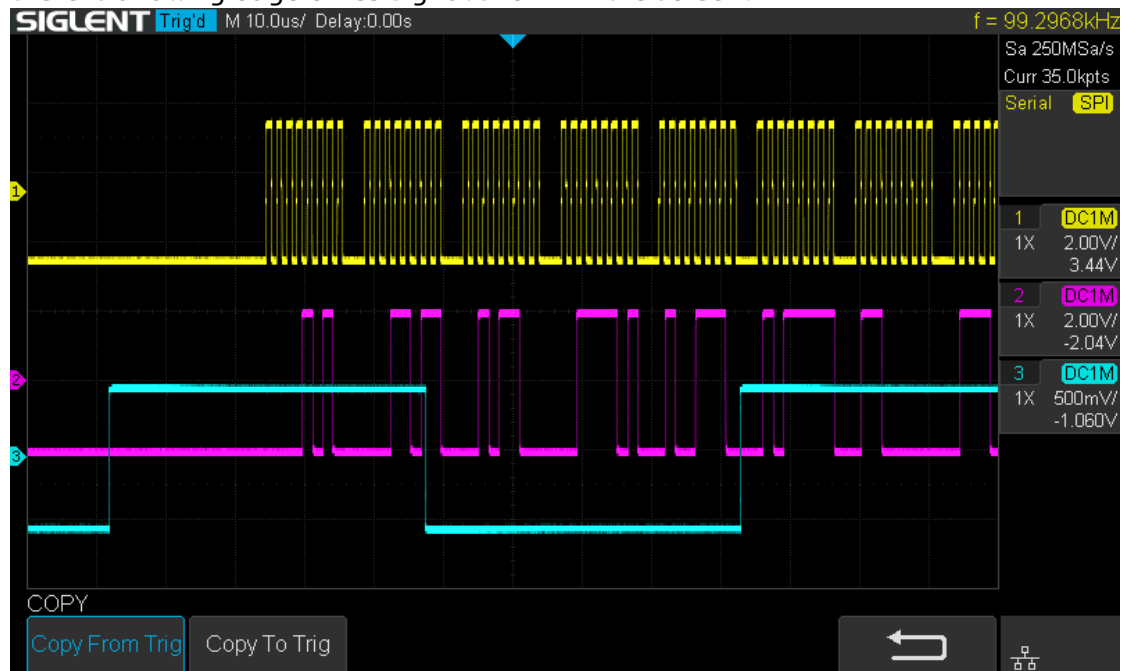

When the CS type is set to Clock Timeout, the clock idle time between frames is T_3 , the clock period is T_1 , then set the timeout to a value between T_1 and T_3 :

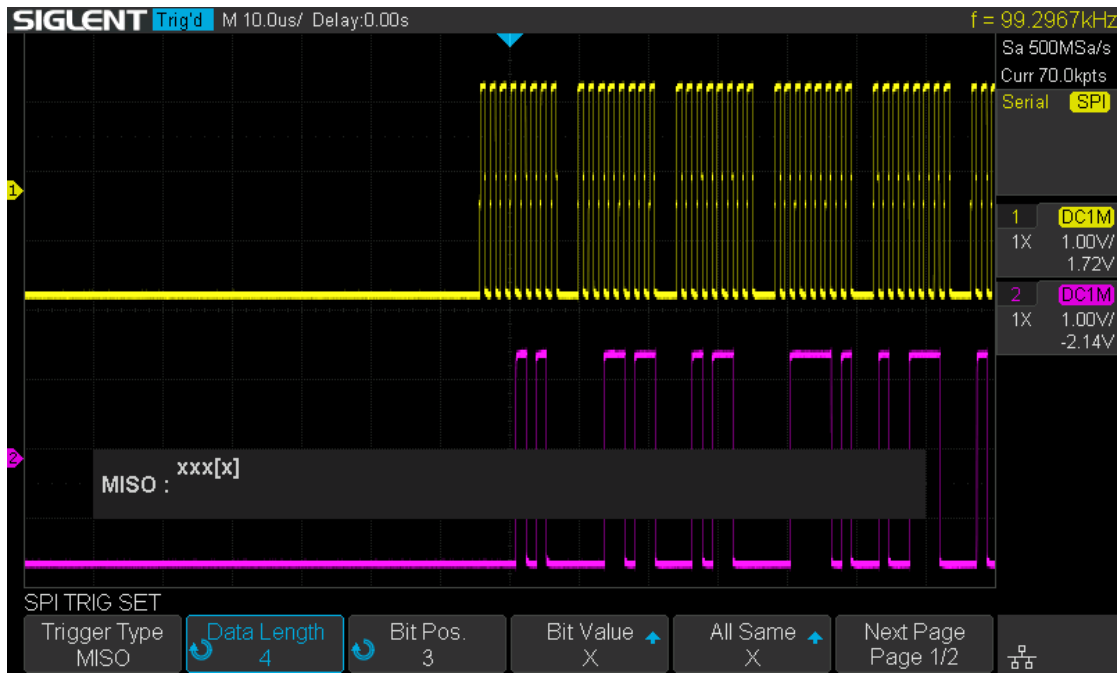

If the data width is set to be greater than 8 bits (such as 16 bits), the clock idle time between 8-bit data packets T2, and then set the timeout time to a value between $T1/2+T2$ and T3.

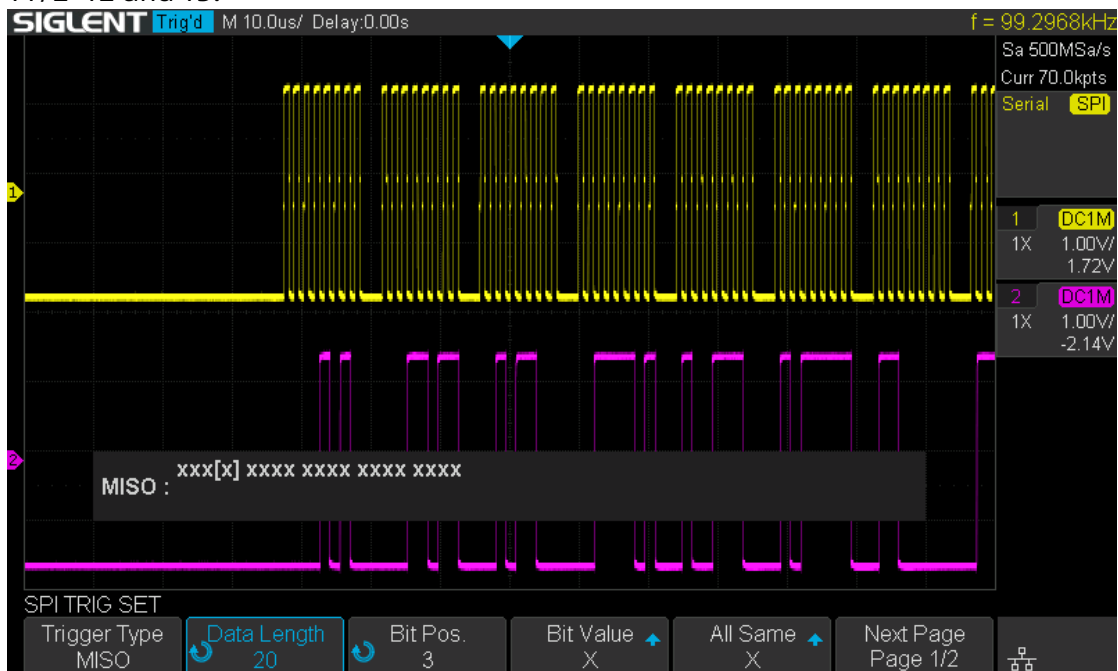

SPI Trigger

This part will provide a brief introduction and description for the operation of the SPI trigger.

1. Press the **Setup** button to enter the **TRIGGER** function menu.
2. Press the **Type** and select **Serial**.
3. Press the **Protocol** and select **SPI**.
4. Press the **Trigger Setting** softkey.



Figure 51 SPI TRIG SET Menu

5. Press the **Trigger Type** softkey to select the trigger condition.

Function Menu	Settings	Explanation
Trigger Type	MISO	Master-In, Slave-Out
	MOSI	Master-Out, Slave-In

Table 2 Menu Explanations of the SPI trigger type

6. Press the Data Length softkey, and turn the Universal Knob to set the length of a data. The range of data length is 4 to 96 bits.
7. Set the value of the trigger data.
 - Set the value of a bit:
 - a. Press the **Bit Roll** softkey to select a bit in data.
 - b. Press the **Bit Value** softkey to set the value of the selected bit.
 - Set the value of all bits:
 - a. Press the **All Same** softkey to set the value of all bits.

Function Menu	Settings	Explanation
Bit Value	0	High voltage level
	1	Low voltage level
	X	Don't care the voltage level

Table 3 Menu Explanations of the SPI Bit value

8. Press the **Next Page** softkey.
9. Press the **Bit Order** softkey to set the bit order (MSB or LSB).

SPI Serial Decode

After completing the setup of SPI signal and trigger, we will decode SPI signals. Operation steps as follows.

1. Press **Decode** → **Decode**. Select one of the options from the **Decode1** and **Decode2**.
2. Press the **Configure** to set the bitstream format and bits (4-32 bits)
3. Press the **Display** and select **On** to display the result of decoding.
4. Press the **Configure** to set bit order and data length.
5. Press the **List** to enter the **LIST** function menu.
 - Press the **Display** and choose the same options as the first step.
 - Press the **Scroll** and turn the **Universal Knob** to view all frames.
 - Press the **Lines** and set the number of lines by **Universal Knob**. The range of the lines is 1 to 7.
 - Users can export the result list of the package to the external USB storage device in csv format (only when the USB flash disk is detected). Saving the data (*.csv) is similar to the operation of setup files, see the section "**External save and recall**" for details.
6. Press the **Format** to change the character encoding format of the decoding's result.
7. Press the **Copy Setting** to enter the **COPY** function menu to synchronize the corresponding bus configuration and trigger configuration.
8. Press the **Tips Info** to turn on or off the decoding limit prompt. When the decoding frame number reaches the maximum, it will pop up "Decoding to maximum frame number limitation!"

Interpreting SPI Decode

The frames of decoding result:

- The data values are displayed in frames and are shown in white. Support 4~96 bit data display.
- MISO — the decoding result of "Master-In, Slave-Out" line.
- MOSI —the decoding result of "Master-Out, Slave-In" line.
-  Indicates there is not enough space on the display to show the complete content of a frame, and some content is hidden.

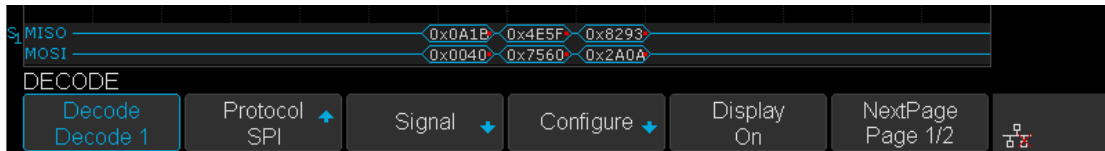

Figure 52 SPI Decode Bus Display

The lists of decoding result:

- Time — the horizontal displacement between current frame and trigger position.
- MISO — the decoding result of “Master-In, Slave-Out” line.
- MOSI — the decoding result of “Master-Out, Slave-In” line.

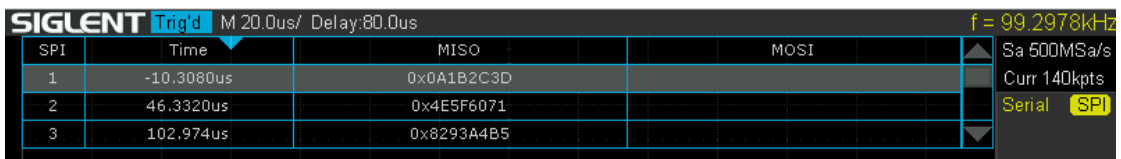

Figure 53 SPI Decode List Display

UART Trigger and Serial Decode

Please in order of “Setup for UART Signals” , “UART Trigger” and “UART Serial Decode” to trigger and decode the signals.

Setup for UART Signals

1. Press the **Decode** key to enter the **DECODE** function menu.
2. Press the **Decode** softkey and select the desired slot (Decode1 or Decode2).
3. Press the **Protocol** softkey and then select **UART** by turning **Universal Knob**.
4. Press the **Signal** softkey to enter the **SIGNAL** menu as below shows.



Figure 54 UART SIGNAL Menu

5. Set RX:
 - a. Press the **RX** to select the channel that is connected to the RX signal.
 - b. Press the first **Threshold** key to set the RX signal’s threshold voltage level by **Universal Knob**. The threshold voltage level is for decoding, and it will be regard as the trigger voltage level when set the trigger type to serial.
6. Set TX:
 - a. Press the **TX** to select the channel that is connected to the TX signal.
 - b. Press the second **Threshold** key to set the TX signal’s threshold voltage level by **Universal Knob**. The threshold voltage level is for decoding, and it will be regard as the trigger voltage level when set the trigger type to serial.
7. Press the **Back** softkey to return previous menu.
8. Press the **Configure** softkey to enter **BUS CONFIG** menu.



Figure 55 BUS CONFIG Menu

9. Press the **Baud** softkey to set baud rate.
 - The baud rate can be set as predefined value.
 - If the desired baud rate is not listed, press the **Baud** and select **custom** option, press the **Custom** and turn the **Universal Knob** to set the desired baud rate.

10. Press the **Data Length** softkey and set byte bits (5-8) by **Universal Knob**.
11. Press the **Parity Check** softkey to set the type of parity check (**Even, Odd, Mark, Space** or **None**).
12. Press the **Stop Bit** softkey to set the length of stop bit (**1, 1.5** or **2 bits**).
13. Press the **Next Page** softkey.
14. Press the **Bit Order** softkey to select the bit order (**LSB** or **MSB**).
15. Press the **Idle Level** softkey to set the idle level (**LOW** or **HIGH**).

UART Trigger

This part shows a brief introduction and description for the operation of the UART trigger.

1. Press the **Setup** button to enter the **TRIGGER** function menu.
2. Press the **Type** and select **Serial**.
3. Press the **Protocol** and select **UART**.
4. Press the **Trigger Setting** softkey to enter **UART TRIG SET** menu.



Figure 56 UART TRIG SET Menu

5. Press the **Source Type** softkey to select the source of trigger (RX or TX).
6. Press the **Condition** softkey and set up the desired trigger condition:
 - **Start** — the oscilloscope will be triggered at the position of start bit.
 - **Stop** — the oscilloscope will be triggered at the position of stop bits.
 - **Data** — the oscilloscope will be triggered when found a byte which is equal to (greater or less than) the specified data.
 - a. Press the **Compare Type** softkey and choose an equality qualifier (>, < or =).
 - b. Press the **Value** softkey to set data's value. Data's value is in range of 0x00 to 0xff.
 - **ERROR** — if the parity check has been set, and the bit of parity check is error, the oscilloscope will be triggered.



Figure 57 UART Trigger

UART Serial Decode

After completing the setup of UART signal and trigger, we will decode UART signals. Operation steps as follows.

1. Press **Decode** → **Decode**. Select one of the options from the **Decode1** and **Decode2**.
2. Press the **Display** and select **On** to display the result of decoding.
3. Press the **Configure** to set the baud rate, data length, parity check, stop bit, idle level and bit order. Refer to “**Setup for UART Signals**” to set parameters.
4. Press the **List** to enter the **LIST** function menu.
 - Press the **Display** and choose the same options as the first step.
 - Press the **Scroll** and turn the **Universal Knob** to view all frames.
 - Press the **Lines** and set the number of lines by **Universal Knob**. The range of the lines is 1 to 7.
 - Users can export the result list of the package to the external USB storage device in csv format (only when the USB flash disk is detected). Saving the data (*.csv) is similar to the operation of setup files, see the section “**External save and recall**” for details.
5. Press the **Format** to change the character encoding format of the decoding's result.
6. Press the **Copy Setting** to enter the **COPY** function menu to synchronize the corresponding bus configuration and trigger configuration.
7. Press the **Tips Info** to turn on or off the decoding limit prompt. When the decoding frame number reaches the maximum, it will pop up "Decoding to maximum frame number limitation!"

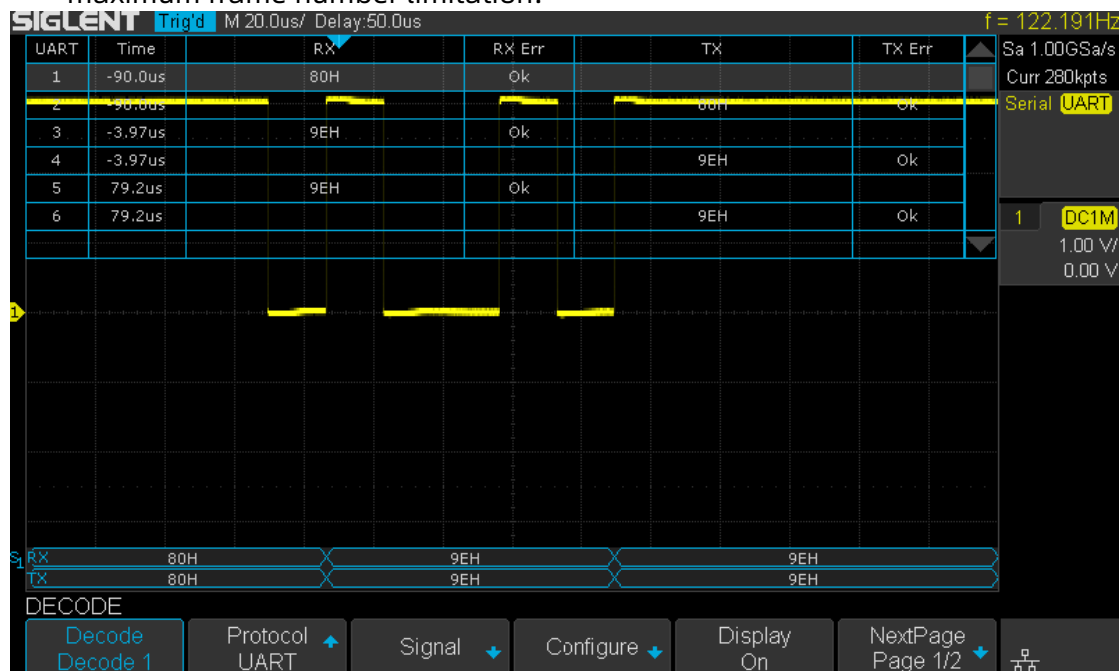



Figure 58 UART Decode

Interpreting UART Decode

The frames of decoding result:

- RX — the decoding result of the data received.
- TX — the decoding result of the data transmitted.
-  Indicates there is not enough space on the display to show the complete content of a frame, and some content is hidden.

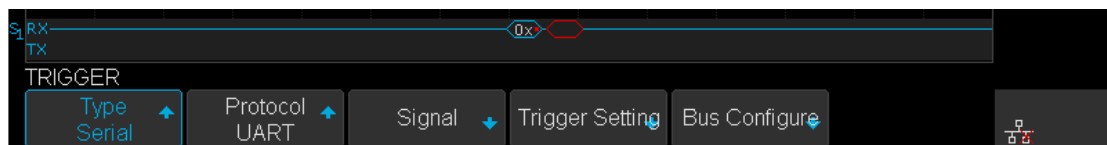

Figure 59 UART Decode Bus Display

The lists of decoding result:

- Time— the horizontal displacement between current frame and trigger position.
- RX — the receiving channel.
- TX — the transmitting channel.
- RX Err— Parity error or unknown error in the data received.
- TX Err— Parity error or unknown error in the data transmitted.

UART	Time	RX	RX Err	TX	TX Err
1	-90.0us	80H	Ok		
2	-90.0us			80H	Ok
3	-3.97us	9EH	Ok		
4	-3.97us			9EH	Ok
5	79.2us	9EH	Ok		
6	79.2us			9EH	Ok

Figure 60 UART Decode List Display

CAN Trigger and Serial Decode

Please in order of “Setup for CAN Signals” , “CAN Trigger” and “CAN Serial Decode” to trigger and decode the signals.

Setup for CAN Signals

1. Press the **Decode** key to enter the **DECODE** function menu.
2. Press the **Decode** softkey and select the desired slot (Decode1 or Decode2).
3. Press the **Protocol** softkey and then select **CAN** by turning **Universal Knob**.
4. Press the **Signal** softkey to enter the **SIGNAL** menu as below shows.



Figure 61 CAN SIGNAL Menu

- a. Press the **Source** softkey to select the channel that is connected to the CAN signal.
 - b. Press the **Threshold** key to set the CAN signal's threshold voltage level by **Universal Knob**. The threshold voltage level is for decoding, and it will be regarded as the trigger voltage level when set the trigger type to serial.
5. Press the **Configure** softkey to enter the **BUS CONFIG** menu.
 6. Press the **Baud** to set baud rate by **Universal Knob**.
 - The baud rate can be set as predefined value (from 5kb/s to 1Mb/s) or custom value (from 5kb/s to 1Mb/s).
 - If the desired baud rate is not listed, press **Baud** and select **custom** option, press the **Custom** and turn the **Universal Knob** to set the desired baud rate.

CAN Trigger

This part will provide a brief introduction and description for the operation of the CAN trigger.

Trigger Conditions

- **Start**— the oscilloscope will be triggered at the start bit of a frame.
- **Remote** — the oscilloscope will be triggered by a remote frame with specified ID.
- **ID** — the oscilloscope will be triggered by a remote or data frame that have specified ID.
- **ID+DATA**— the oscilloscope will be triggered by data frame that have specified ID and data.
- **Error** — the oscilloscope will be triggered by an error frame.

Operation Steps

1. Press the **Setup** to enter the **TRIGGER** function menu.
2. Press the **Type** and select **Serial**.
3. Press the **Protocol** and select **CAN**.
4. Press the **Trigger Setting** to enter the **CAN TRIG SET** menu.
5. Press the **Condition** and select the trigger condition by **Universal Knob**:
 - If you select the **REMOTE** and **ID** condition:
 - a. Press the **ID Bits** to set the length of ID (11bits or 29 bits).
 - b. Press the **Curr ID Byte** and use the **Universal Knob** to select the byte that you want to set.
 - c. Press the **ID** and set the ID's value by the **Universal Knob**.
(**Tips**: In order to make it convenient for the operation to set the parameters, ID b is split into several bytes. For example, if the ID's length is 11 bits, it will be split into two bytes, a byte includes 8 bits. If "1st byte" is selected, only the 8 least significant bits can be changed.)
 - If you select the **ID+DATA** condition:
 - a. Press the **ID bits** softkey to select the ID's length (11 or 29 bits).
 - b. Press the **Curr ID Byte** softkey and use **Universal Knob** to select the byte that you want to modify.
 - c. Press the **ID** softkey and set the ID's value by **Universal Knob**.
 - d. Press the **Data** softkey and set the value of the first byte by **Universal**

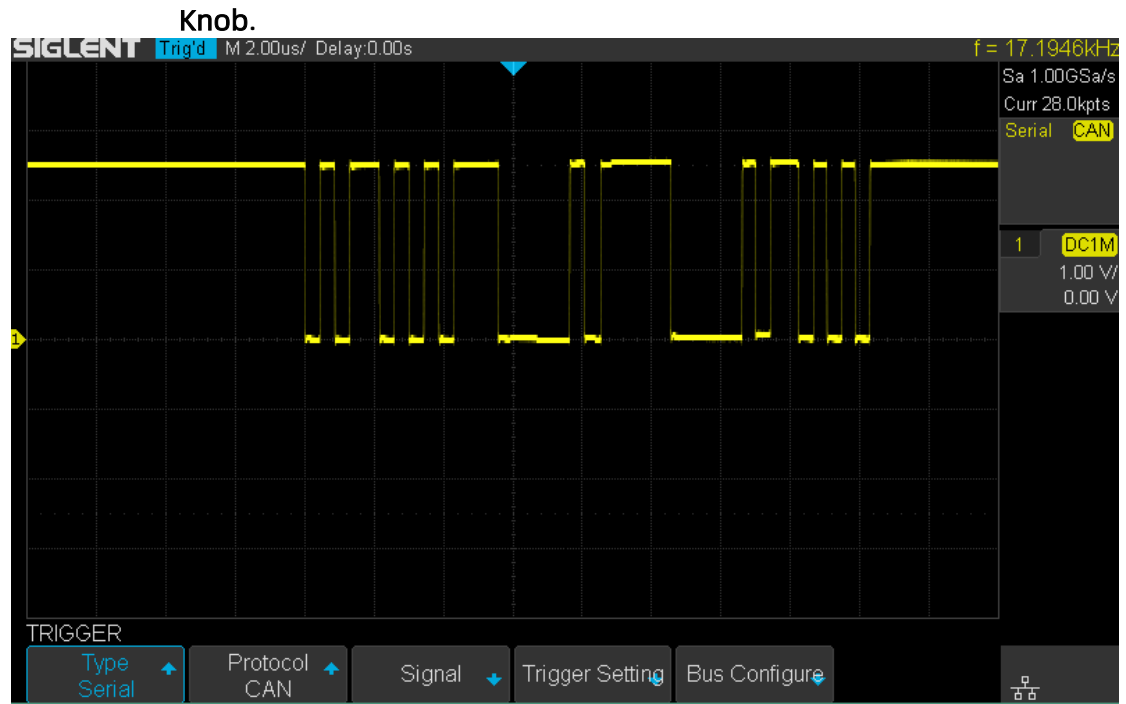

Figure 62 CAN Trigger

CAN Serial Decode

After completing the setup of can signal and trigger, we will decode CAN signals. Operation steps as follows.

1. Press **Decode** → **Decode**. Select one of the options from the **Decode1** and **Decode2**.
2. Press the **Display** and select **On** to display the result of decoding.
3. Press the **Configure** to set the baud rate.
4. Press the **List** to enter the **LIST** function menu.
 - Press the **Display** and choose the same options as the first step.
 - Press the **Scroll** and turn the **Universal Knob** to view all frames.
 - Press the **Lines** and set the number of lines by **Universal Knob**. The range of the lines is 1 to 7.
 - Users can export the result list of the package to the external USB storage device in csv format (only when the USB flash disk is detected). Saving the data (*.csv) is similar to the operation of setup files, see the section "**External save and recall**" for details.
5. Press the **Format** to change the character encoding format of the decoding's result.
6. Press the **Copy Setting** to enter the **COPY** function menu to synchronize the corresponding bus configuration and trigger configuration.
7. Press the **Tips Info** to turn on or off the decoding limit prompt. When the decoding frame number reaches the maximum, it will pop up "Decoding to maximum frame number limitation!"

Interpreting CAN Decode.

The frame of decoding result:

- Arbitration field is displayed in frame
- Control field is displayed in frame
- Data field is displayed in frame
- CRC field is displayed in frame
-  Indicates there is not enough space on the display to show complete content of a frame and some content is hidden.

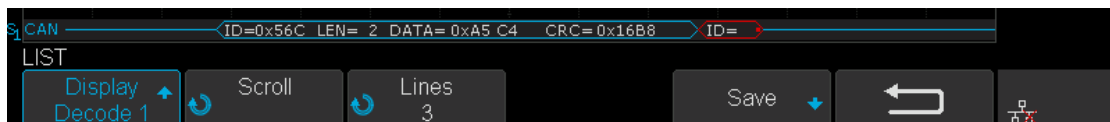

Figure 63 CAN Decode Bus Display

The list of decoding result:

- Time— the horizontal displacement between current frame and trigger position.
- Type — the type of frames, “D” represents data frame, “R” represents remote frame.
- ID — the id of frames, the oscilloscope can automatically detect the length of frame’s id (11 bits or 27 bits).
- Length — the length of data field.
- Data — the value of data field.
- CRC — the value of CRC (Cyclic Redundancy Check) field.
- ACK — Acknowledgment bit.

CAN	Time	Type	ID	Length	Data	CRC	ACK
1	-18.9655ms	D	0x56C	2	0xA5 C4	0x16B8	yes
2	-18.2711ms						no
3	-4.55200us	D	0x56C	2	0xA5 C4	0x16B8	yes

Figure 64 CAN Decode List Display

LIN Trigger and Serial Decode

Please take the order of “Setup for LIN Signals” , “LIN Trigger” and “LIN Serial Decode” to trigger and decode the signals.

Setup for LIN Signals

There are two steps of setting the LIN signal, connecting the signal to oscilloscope, specifying the parameters of each input signal.

1. Press the **Decode** button to enter the DECODE function menu.
2. Press the **Decode** softkey and select the desired slot (Decode1 or Decode2).
3. Press the **Protocol** softkey and then select **LIN** by turning **Universal Knob**.
4. Press the **Signal** softkey to enter the **SIGNAL** menu as below shows.



Figure 65 LIN SIGNAL Menu

5. Press the **Source** softkey to select the channel that is connected to the LIN signal.
6. Press the **Threshold** softkey and set the LIN signal's threshold voltage level by **Universal Knob**. The threshold voltage level is for decoding, and it will be regard as the trigger voltage level when set the trigger type to serial.
7. Press the **Back** softkey to return previous menu.
8. Press the **Configure** softkey to enter the **BUS CONFIG** menu.
9. Press the **Baud** softkey to set baud rate.
 - The baud rate can be set as predefined value.
 - If the desired baud rate is not listed, select **custom** option, press the **Custom** and turn the **Universal Knob** to set the desired baud rate.

LIN Trigger

This part will provide a brief introduction and description for the operation of the LIN trigger.

Trigger Conditions

- **Break** — the oscilloscope will be triggered at the position of break field's break delimiter.
- **ID (Frame ID)** — the oscilloscope will be triggered at the position of identifier field's stop bit, if the value of a frame's ID is equal to specified value.
(**Note:** If the data's value is 0xXX, any data value will be matched)
- **ID + Data (Frame ID and Data)** — the oscilloscope triggers when a frame with an ID and data equal to the selected values is detected. Use the **Universal Knob** to select the value for the ID, Data1 and Data2.
 - a. The ID's value is the same as set value.
 - b. If you have set either Data1's or Data2's value, and the signal has a data is the same as that value. If you have set both Data1's and Data2's value, the signal should has two consecutive data, the first data's value is Data1, second data value is Data2.
(**Note:** If the data's value is 0xXX, any data value will be matched)
- **Data Error** —the oscilloscope will be triggered when errors (such as ID check error, checksum error, sync byte field error) are detected.

Operation Steps

1. Press the **Setup** button to enter the **TRIGGER** function menu.
2. Press the **Type** and select **Serial**.
3. Press the **Protocol** and select **I2C**.
4. Press the **Trigger Setting** softkey to enter **LIN TRIG SET** menu.
5. Press the **Condition** and select the trigger condition by **Universal Knob**:
 - If you select **ID** condition:
 - a. Press the **ID** softkey and set its value by turning the **Universal Knob**.
 - If you select **ID+DATA** condition:
 - a. Press the **ID** softkey and set its value by turning the **Universal Knob**.
 - b. Press the **DATA1** softkey and set its value by turning the **Universal Knob**.
 - c. Press the **DATA2** softkey and set its value by turning the **Universal Knob**.

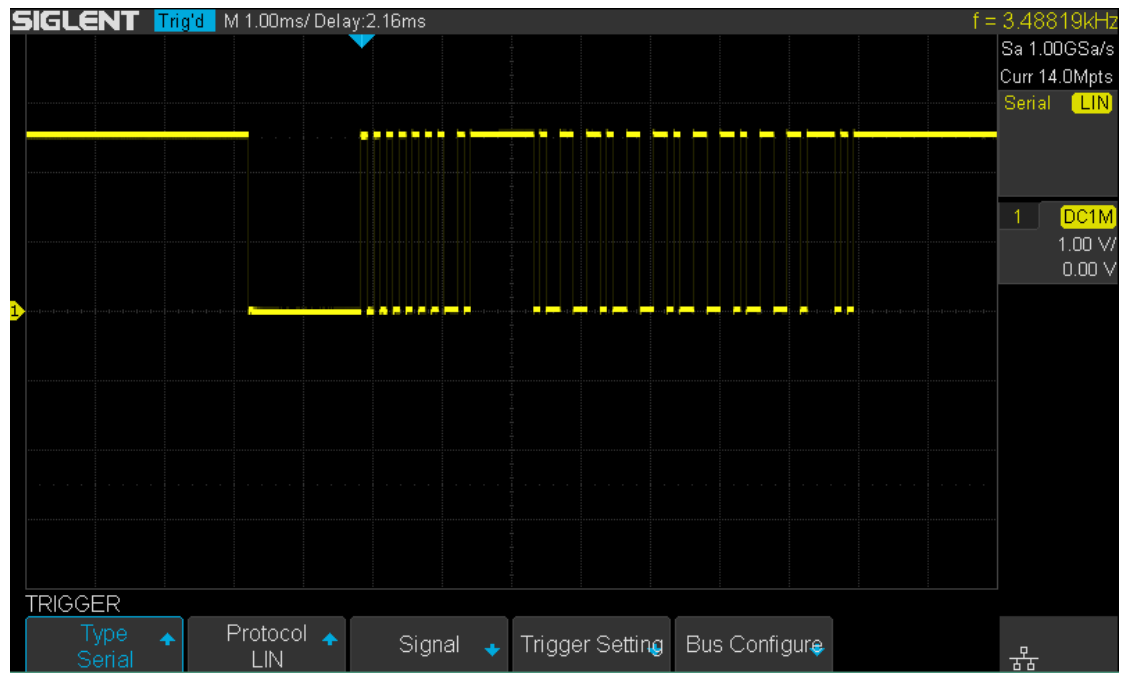

Figure 66 LIN Trigger

LIN Serial Decode

After completing the setup of LIN signal and trigger, we will decode LIN signals. Operation steps as follows.

1. Press **Decode** → **Decode**. Select one of the options from the **Decode1** and **Decode2**.
2. Press the **Display** and select **On** to display the result of decoding.
3. Press the **Configure** to set the baud rate.
4. Press the **List** to enter the **LIST** function menu.
 - Press the **Display** and choose the same options as the first step.
 - Press the **Scroll** and turn the **Universal Knob** to view all frames.
 - Press the **Lines** and set the number of lines by **Universal Knob**. The range of the lines is 1 to 7.
 - Users can export the result list of the package to the external USB storage device in csv format (only when the USB flash disk is detected). Saving the data (*.csv) is similar to the operation of setup files, see the section "External save and recall" for details.
5. Press the **Format** to change the character encoding format of the decoding's result.
6. Press the **Copy Setting** to enter the **COPY** function menu to synchronize the corresponding bus configuration and trigger configuration.
7. Press the **Tips Info** to turn on or off the decoding limit prompt. When the decoding frame number reaches the maximum, it will pop up "Decoding to maximum frame number limitation!"

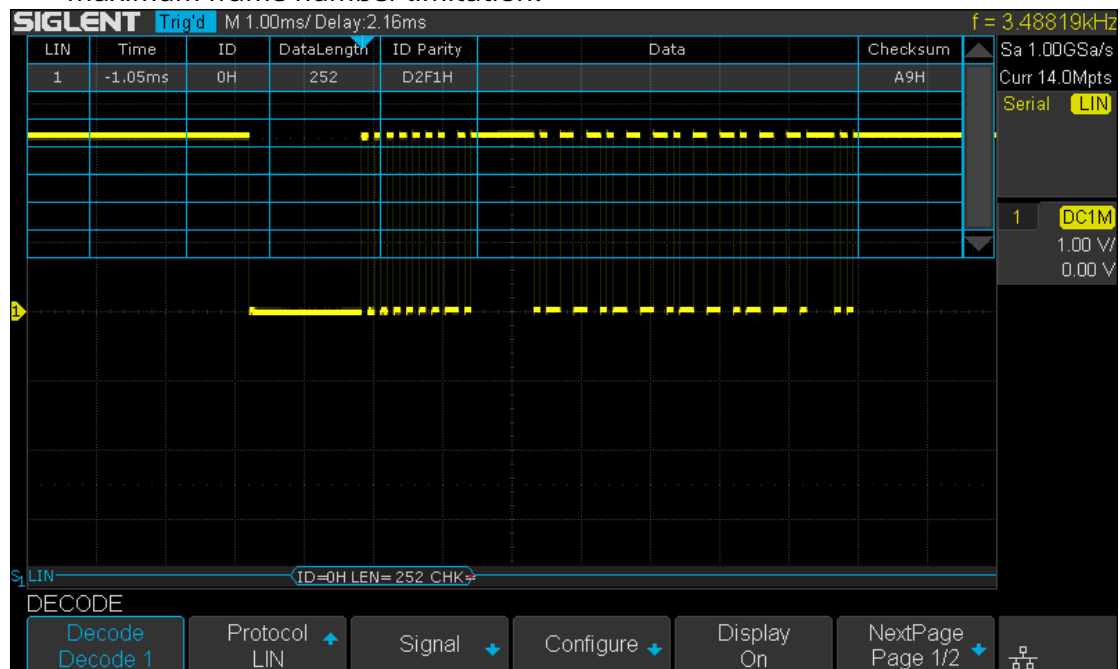



Figure 67 LIN Decode

Interpreting LIN Decode

The frame of decoding result:

- Protected Identifier Field is displayed in frame
- Data Length is displayed in frame
- Data Field is displayed in frame.
- Checksum Field is displayed in frame.
-  Indicates there is not enough space on the display to show complete content of a frame and some content is hidden.

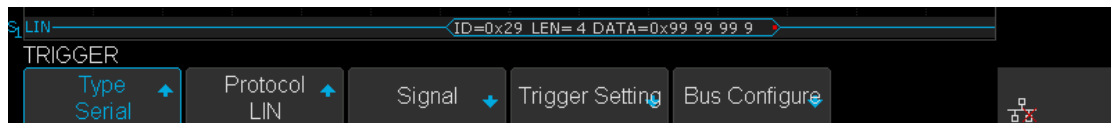

Figure 68 LIN Decode Bus Display

The list of decoding result:

- Time— the horizontal displacement between current frame and trigger position.
- ID — the value of frame’s Protected Identifier Field.
- Data Length — the length of Data Field.
- ID Parity — the two check bits of Protected Identifier Field.
- Data — the value of Data Field.
- Checksum— the value of Checksum Field.

LIN	Time	ID	Data Length	ID Parity	Data	Checksum
1	-1.79606ms	0x29	4	0x03	0x99 99 99 99	0xAF

Figure 69 LIN Decode List Display

Reference Waveform

The oscilloscope can save analog channel or math waveforms to the reference waveform locations in the oscilloscope. Then, a reference waveform can be displayed and compared against other waveforms. All reference waveforms can be displayed at a time.

The contents of this chapter:

- ◆ Save REF Waveform to Internal Memory
- ◆ Display REF Waveform
- ◆ Adjust REF Waveform
- ◆ Clear REF Waveform

Save REF Waveform to Internal Memory

Do the following steps to save the REF waveform to internal memory:

1. Press the **REF** button on the front panel to enter the REF WAVE function menu. Note that when the time horizontal format is in X-Y mode, REF function cannot be enabled.
2. Press the **Source** softkey; then, turn the **Universal Knob** to select the source of reference channel. The source includes analog channel and math waveforms.
3. Press the **Location** softkey; then, turn the **Universal Knob** to select the position to save the REF waveform. The source includes analog channel and math waveforms.
4. Press the **Save** softkey to save the channel or math waveform to the appointed location. The vertical scale information and the vertical offset of the waveform will be saved at the same time. It will pop out the message “**Saved to internal file REF***” when the waveform has been saved successfully.

Note: The REF waveforms are non-volatile. The REF waveform can still be saved after restarts or default operation.

Display REF Waveform

To the following steps to display REF waveform:

1. Press the **REF** button on the front panel to enter the REF WAVE function menu.
2. Press the **Location** softkey; then, turn the **Universal Knob** to select the REF waveform that you want to display.
3. Press the **Display** softkey to select **On** to display the REF waveform on the screen. Only saved location can be displayed. The oscilloscope can display all four reference waveforms at the same time.

Adjust REF Waveform

1. Please refer to the “Display REF Waveform” above to display the desired reference waveform.
2. Press the **Scale** and **Position** softkey and turn the **Universal Knob** to adjust the vertical scale and position of the reference waveform. The vertical scale and position information display at the middle of the screen.

The initial values display at the middle of the screen is the setup that when the reference waveform been saved.

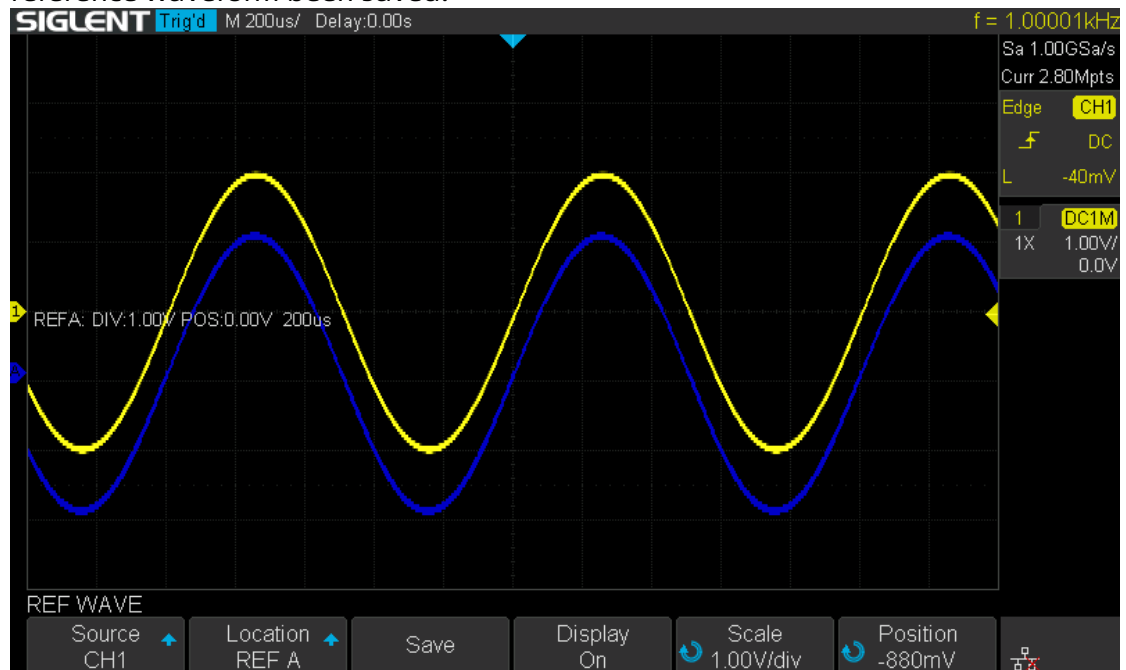

Figure 70 Reference Waveform

Clear REF Waveform

The oscilloscope does not have the “Clear” option under the REF WAVE function menu. To clear the appointed reference waveform, you can save a new reference waveform to the same location to cover it. Or follow the **Save/Recall** → **Recall** → **type** and select **Security Erase** to clear the stored waveform.

Math

The oscilloscope supports many math operations between analog channels including addition (+), subtraction (-), multiplication (*), division (/), FFT, differential (d/dt), integral ($\int dt$), square root ($\sqrt{\quad}$). The resulting math waveform is displayed in white and labeled with "M". You can use cursors to measure it.

The contents of this chapter:

- ◆ Units for Math Waveforms
- ◆ Math Operators

Note: if the analog channel or the math function is cut off (waveforms do not display on the screen completely), the resulting math will also be cut off.

Units for Math Waveforms

Use the channel function menu to set the unit of each channel to "V" or "A" .
The oscilloscope math operation includes units as below:

Math Operation	Unit
Addition (+)or subtraction (-)	V, A
multiplication (*)	V ² , A ² or W
division (/)	SDS1000X-E: None, Ω (Resistance unit Ohms) or S (conductance unit Siemens) SDS1000X-U: None, V*A ⁻¹ or V ⁻¹ *A
FFT	dBVrms, Vrms, dBm, dBArms, Arms
differential (d/dt)	SDS1000X-E: V/S or A/S (V/second or A/second) SDS1000X-U: V*S ⁻¹ or A*S ⁻¹
integral (∫ dt)	Wb, C
square root ($\sqrt{\quad}$)	V ^{1/2} or A ^{1/2}

Math Operators

The oscilloscope supports math count operation (Addition, subtraction, multiplication, division), FFT (Fourier transform) operation and math function operation (differential, integral, square root).

Addition or Subtraction

Math operators perform arithmetic operations add or subtract operation on any two analog input channels. When you select addition or subtraction, the **Source A** and **Source B** values are added or subtracted point by point, and the result is displayed.

1. Press the **Math** button on the front panel to enter the MATH function menu.
2. Press the **Source A** and **Source B** softkey respectively, and then turn the **Universal Knob** to select the source to do math operation. Addition or Subtraction can be applied between analog channels.
3. Press the **Operator** softkey and then turn the **Universal Knob** to select **+** or **-** to make addition or subtraction operation. The resulting math waveform is displayed in white and labeled with "M".

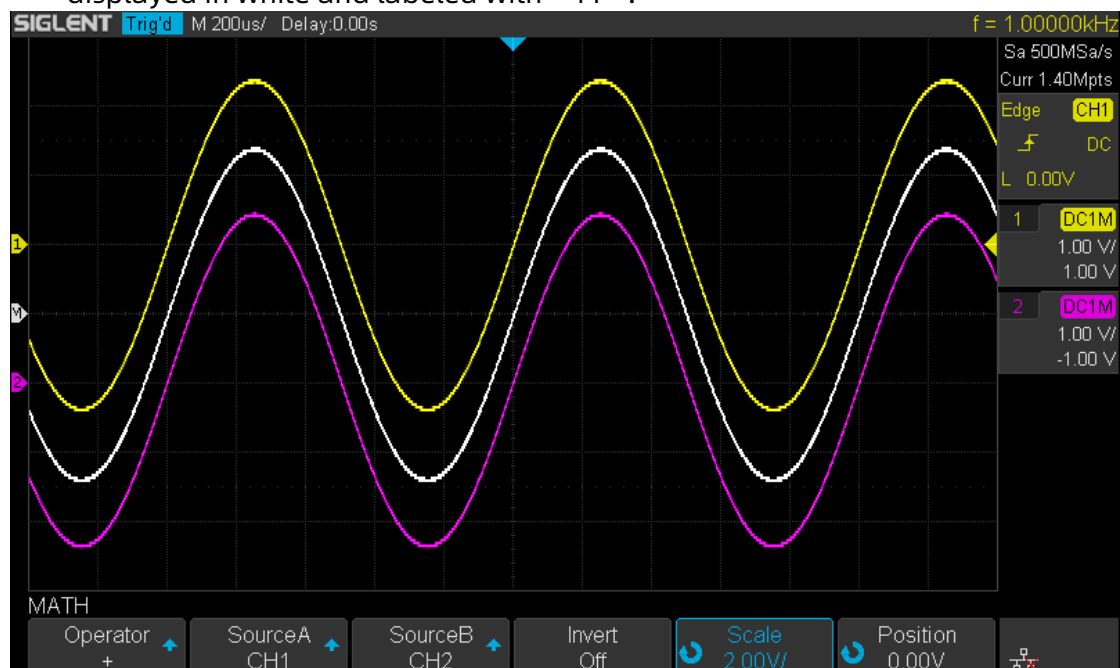

Figure 71 C1+C2 Waveform

4. If you want to invert the math waveform, press the **Invert** button and set the option to **On** to invert the display of the math waveform.

Multiplication and Division

Math operators perform arithmetic operations multiplication or division operation on any two analog input channels. When you select multiplication or division, the **Source A** and **Source B** values are multiplied or divided point by point and the result is displayed.

1. Press the **Math** button on the front panel to enter the MATH function menu.
2. Press the **Source A** and **Source B** softkey respectively, and then turn the **Universal Knob** to select the source to do math operation. Multiplication or Division can be applied between analog channels.
3. Press the **Operator** softkey and then turn the universal to select * or / to make multiplication or division operation. The resulting math waveform is displayed in white and labeled with "M" .

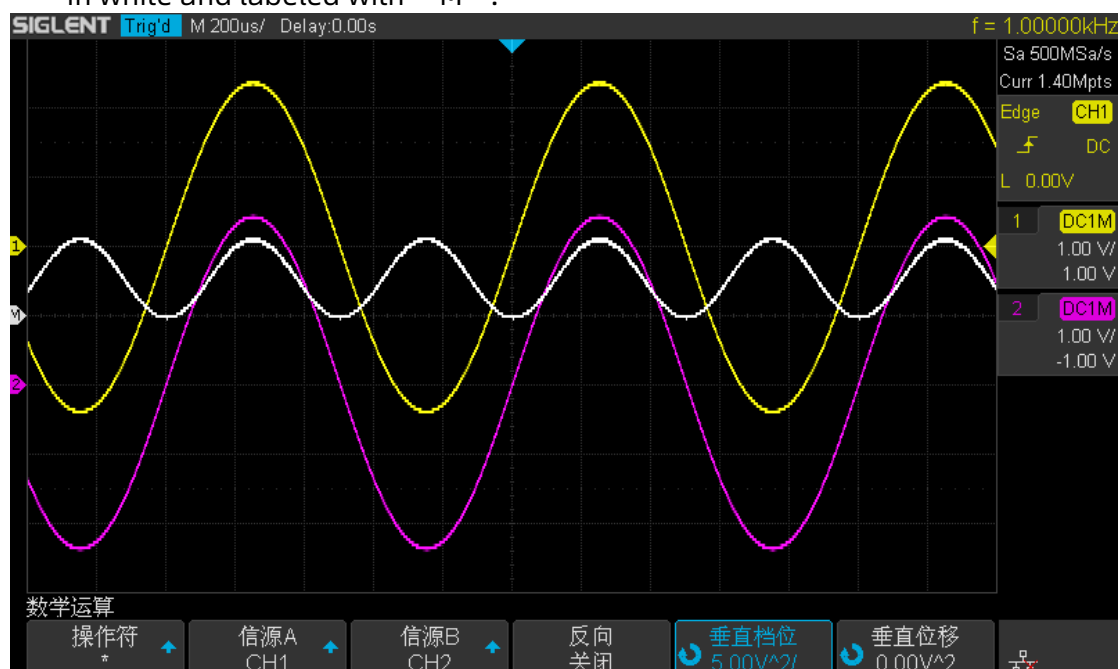

Figure 72 C1*C2 Waveform

4. If you want to invert the math waveform, press the **Invert** button and set the option to **On** to invert the display of the math waveform.

FFT Operation

FFT is used to compute the fast Fourier transform using analog input channels. FFT takes the digitized time record of the specified source and transforms it to the frequency domain. When the FFT function is selected, the FFT spectrum is plotted on the oscilloscope display as magnitude in dBV versus frequency. The readout for the horizontal axis changes from time to frequency (Hertz) and the vertical readout changes from V to dB.

FFT operation can facilitate the following works:

- ◆ Measure harmonic components and distortion in the device under test
- ◆ Measure the characteristics of the noise in DC power
- ◆ Analyze vibration

To display a FFT waveform:

1. Press the **Math** button on the front panel to open the MATH function menu.
2. Press the **Operator** softkey and then turn the **Universal Knob** to select **FFT**. The resulting math waveform is displayed in white and labeled with "M" .



Figure 73 FFT Menu

3. Press the **Source** softkey, and then turn the **Universal Knob** to select the source to do FFT operation. Analog channels can be used as the source.
4. Press the **Config** softkey to enter CONFIG menu.

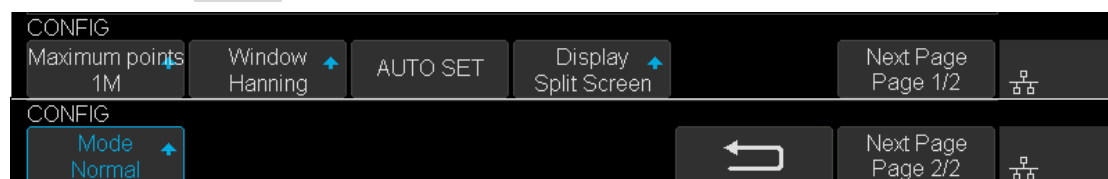

Figure 74 FFT CONFIG Menu

- Press the **Maximum points** softkey, and then turn the **Universal Knob** to select the Maximum points.
- Press the **Window** softkey, and then turn the **Universal Knob** to select an appropriate window.

Spectral leakage can be considerably decreased when a window function is used. The oscilloscope provides five windows (Rectangle, Blackman, Hanning, Hamming and Flattop) which have different characteristics and are applicable to measure different waveforms. You need to select the

window function according to different waveforms and their characteristics. Please read the table below carefully to make an appropriate option according to the input signal.

Window	Applications and Characteristics
Rectangle	These are normally used when the signal is transient (completely contained in the time-domain window) or known to have a fundamental frequency component that is an integer multiple of the fundamental frequency of the window. Signals other than these types will show varying amounts of spectral leakage and scallop loss, which can be corrected by selecting another type of window.
Hanning	These reduce leakage and improve amplitude accuracy. However, frequency resolution is also reduced.
Hamming	These reduce leakage and improve amplitude accuracy. However, frequency resolution is also reduced.
Flat Top	This window provides excellent amplitude accuracy with moderate reduction of leakage, but with reduced frequency resolution.
Blackman	It reduces the leakage to a minimum, but with reduced frequency resolution.

- Press the **Auto set** softkey to automatically set the appropriate parameters for the FFT measurement.
- Press the **Display** softkey to select **Split Screen**, **Full Screen** or **Exclusive** display mode.

Split Screen: Time domain waveform and frequency domain waveform are displayed separately. The time domain waveform is on the upper half screen, while the frequency domain waveform is located within the lower half of the display. In Split mode, if Zoom is enabled, the zoom waveform and the frequency domain waveform are displayed on the lower half screen together.

Full Screen: Time-domain waveform and frequency-domain waveform are displayed together.

Exclusive: Only the frequency-domain waveform is displayed.

- Press the **Mode** softkey to select **Normal**, **Max-Hold** or **Average**. When you select **Average**, it is necessary to set the average times.

5. Press the **Vertical** softkey to enter VERTICAL menu.



Figure 75 VERTICAL Menu

- Press the **Scale** softkey, and then turn the **Universal Knob** to select the desired vertical FFT scale
- Press the **Ref Level** softkey, and then turn the **Universal Knob** to select the

- desired vertical FFT offset.
 - Press the **Unit** softkey to select the unit of vertical axis. The units of the vertical axis can be dBVrms, dBm, Vrms or dBArms, Arms, which use a logarithmic scale or a linear scale to display vertical amplitude respectively.
 - Press the **Ext Lode** softkey and then turn the **Universal Knob** to select the external load value.
6. Press the **Horizontal** softkey to enter HORIZONTAL menu.



Figure 76 HORIZONTAL Menu

- Press the **Center** softkey, and then turn the **Universal Knob** to select the desired center frequency.
 - Press the **Hz/div** softkey, and then turn the **Universal Knob** to select the desired resolution frequency.
7. Press the **Tools** softkey to enter TOOLS menu(only 4-channel supports this function). Press **Type** softkey to select the type of tools. The type of the tools can be **Peaks**, **Markers**, or **Off**.

Peaks: Automatically mark the peak of the current FFT waveform according to the search configuration.



Figure 77 FFT Peaks Menu

- Press the **Show Table** softkey to display a table of peak, and press **Show Frequency** softkey to display the frequency value of the peak. Press the **Sort By** softkey continuously to set the table sorting by Amplitude or Frequency.
- Press the **Search Config** softkey to set search configuration.



Figure 78 SEARCH Menu

- a. Press the **Threshold** softkey and turn the **Universal knob** to set the minimum peak amplitude. Only peaks larger than the peak limit can be judged as peaks.
- b. Press the **Excursion** softkey and turn the **Universal knob** to set the difference between the peak value and the minimum Amplitude on both sides. Only when the difference is greater than the peak value of peak offset can the peak value be determined.

Markers: Customize the marker locations on the FFT waveform based on search configuration.

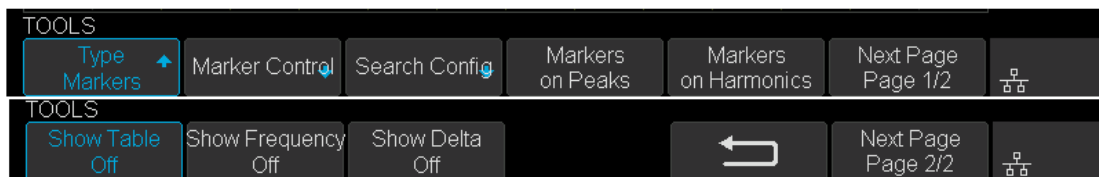

Figure 79 FFT Markers Menu

- Press **Markers Control** softkey to enter MARKER Menu.



Figure 80 Marker Control Menu

- Press the **Marker** softkey continuously to select the marker number from NO.1~NO.8.
 - Press the **Show Marker** softkey continuously to turn on or off the selected mark.
 - Press the **Frequency** softkey to set the frequency value of the selected marker.
 - Press the **Next Peak** softkey to move the selected mark to the next peak. And press the **Next Amplitude** softkey to move the selected marker to the next peak with lower amplitude.(Up to 10 peaks are supported)
- Press the **Search Config** softkey to enter the SEARCH menu. Similar to the **search configuration** for peak markers.
 - Press the **Markers on Peaks** softkey to set the markers on peaks, and press the **Markers on Harmonics** softkey to set the markers on harmonics.
 - Press the **Show Table** softkey to show the amplitude of the markers; press the **Show Frequency** softkey to show the frequency value of the markers, and press the **Show Delta** softkey to show the delta amplitude between markers.

The following figure shows the FFT waveform displayed on the split screen and the peak tool is turned on:

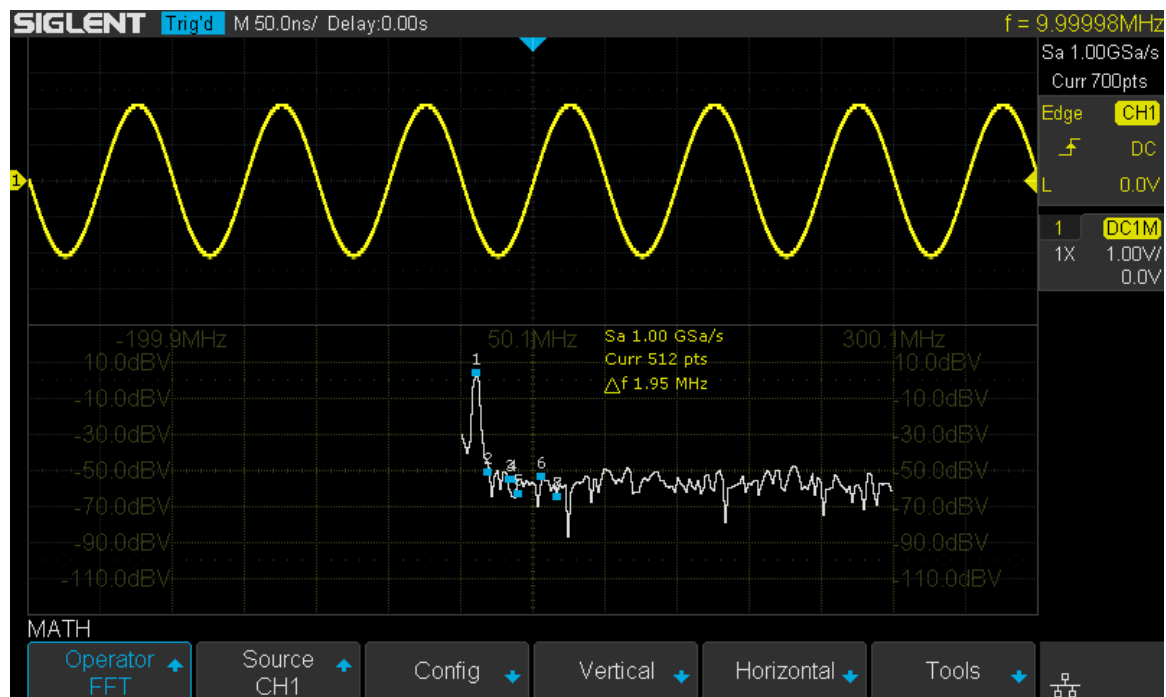

Figure 81 FFT Waveform

Note:

- Signals with DC components or deviation would cause error or deviation of the FFT waveform components. To reduce the DC components, set the Channel **Coupling** to AC.
- To reduce the random noise and aliasing frequency components of repetitive or single pulse, set the **Acquisition** of the oscilloscope to Average.

To measure FFT waveform:

To make cursor measurements, press the **Cursors** button, and then press the **Mode** softkey to select **On** to turn the cursors. Use the X1 and X2 cursors to measure frequency values and the difference between two frequency values (ΔX). Use the Y1 and Y2 cursors to measure amplitude in dB and difference in amplitude (ΔY). You can find the frequency value at the first occurrence of the waveform maximum by using the X at Max Y measurement.

Note: please refer to the cursors chapter to obtain the method of using cursors.

Math Function Operation

The oscilloscope supports math function operation including differential (d/dt), integral ($\int dt$) and square root ($\sqrt{\quad}$).

Differentiate

d/dt (differentiate) calculates the discrete time derivative of the selected source.

$$d_i = \frac{y(i + \Delta t) - y(i - \Delta t)}{2 \Delta t}$$

Where:

- d = differential waveform
- y = channel 1, 2, 3, or 4 data points
- i = data point index
- Δt = point- to- point time difference

The **dx** option under d/dt math function operation menu shows the point- to- point time difference, and it ranges from 0.02div to 0.40div. “div” indicates the number of the pixel points that each division has. The oscilloscope has 50 pixel points per division. Take 0.2div as an example: $0.2 * 50 = 10$. It means to calculate the ten point’s discrete time derivative of the selected source, and the Δt is the ten point’s point- to- point time difference.

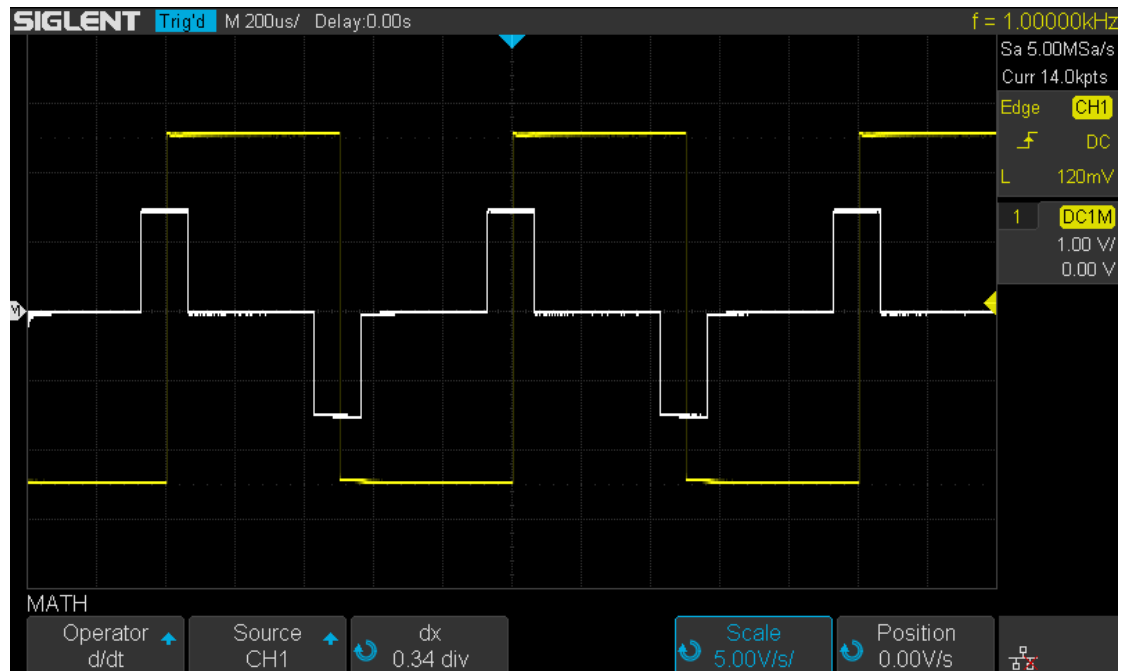

Figure 82 Difference Function Operation

You can use differentiate to measure the instantaneous slope of a waveform. For example, the slew rate of an operational amplifier may be measured using the differentiate function

Note: Because differentiation is very sensitive to noise, it is helpful to set acquisition mode to **Average**.

Integrate

dt (integrate) calculates the integral of the selected source. You can use integrate to calculate the energy of a pulse in volt- seconds or measure the area under a waveform.

dt plots the integral of the source using the "Trapezoidal Rule". The equation is:

$$I_n = c_0 + \Delta t \sum_{i=0}^n y_i$$

Where:

- I = integrated waveform
- Δt = point- to- point time difference
- y = channel 1, 2, 3, or 4 data points
- c_0 = arbitrary constant
- i = data point index

The integrate operator provides an **Offset** softkey that lets you enter a DC offset correction factor for the input signal. Small DC offset in the integrate function input (or even small oscilloscope calibration errors) can cause the integrate function output to "ramp" up or down. This DC offset correction lets you level the integrate waveform.

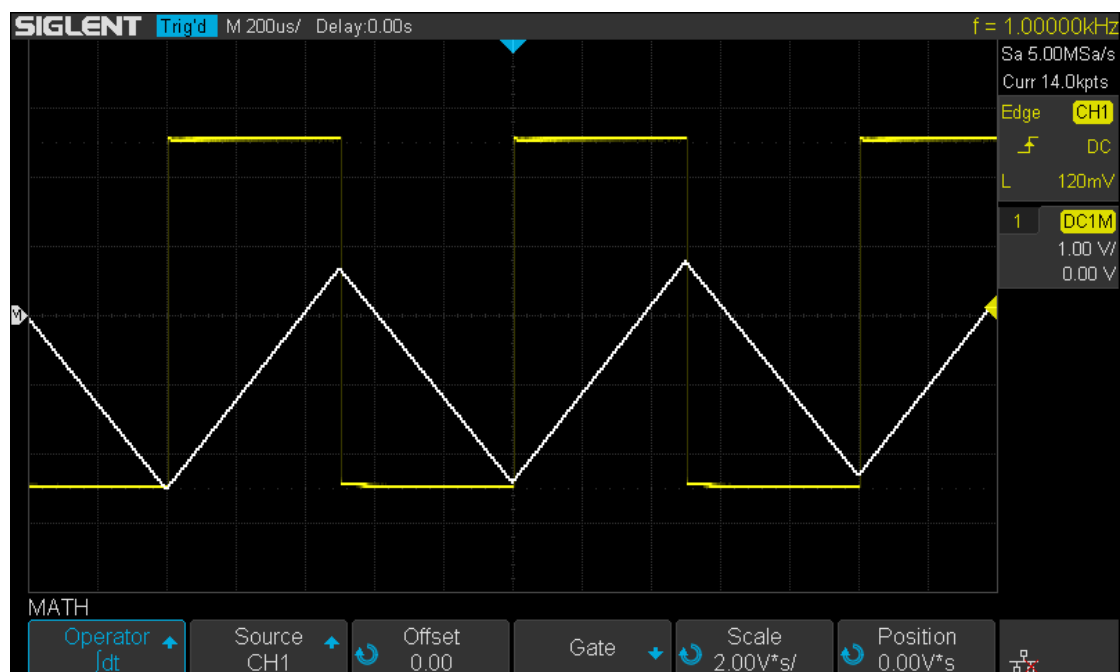

Figure 83 Integral without Offset

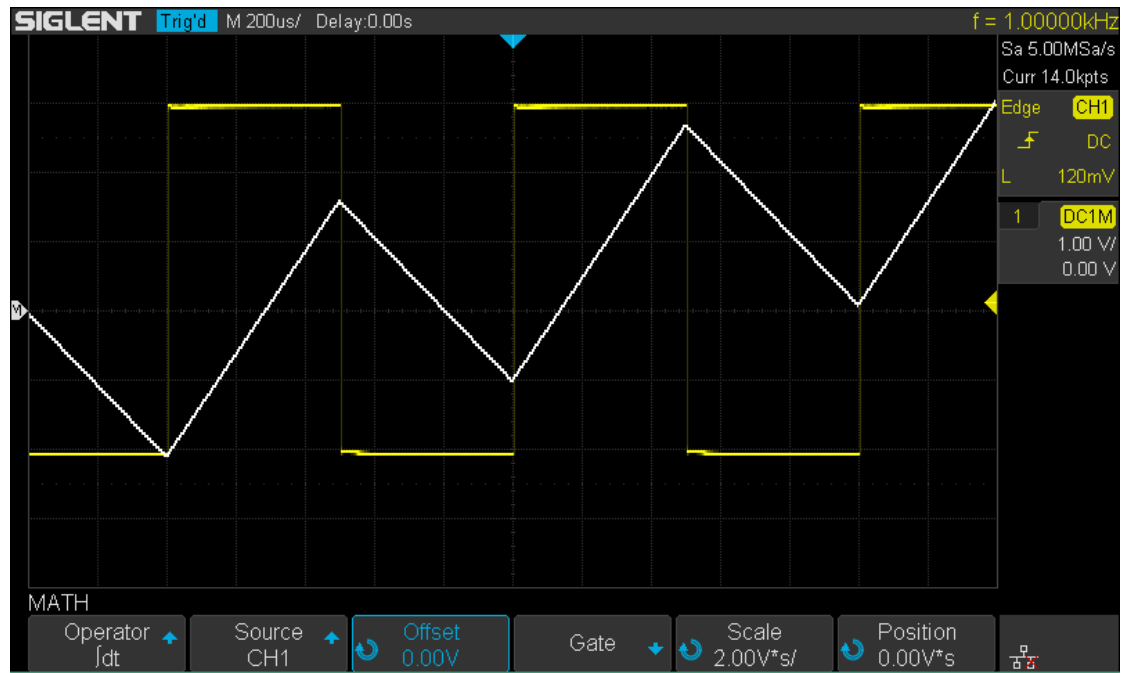

Figure 84 Integral with Offset

Square Root

Square root ($\sqrt{\quad}$) calculates the square root of the selected source.

Where the transform is undefined for a particular input, holes (zero values) appear in the function output.

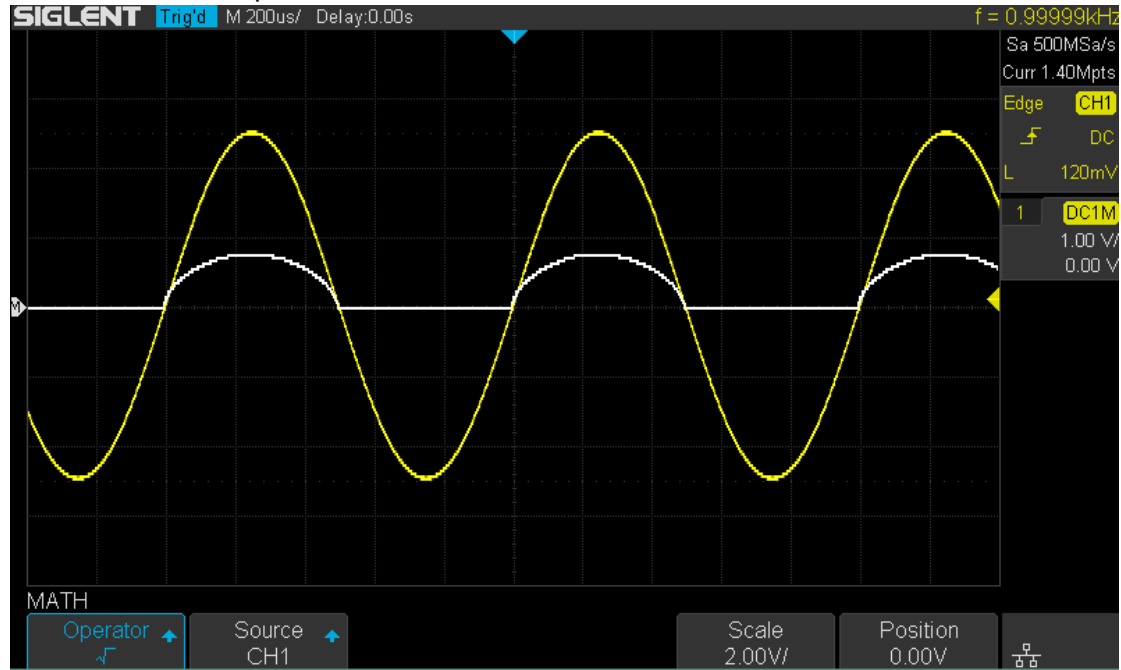

Figure 85 Square Root

Cursors

Cursors are horizontal and vertical markers that indicate X- axis values and Y- axis values on a selected waveform source. You can use cursors to make custom voltage, time measurements on oscilloscope signals.

X Cursors

X cursors are vertical dashed lines that adjust horizontally and can be used to measure time (when the source is FFT waveform, X cursors measure frequency).

X1 cursor is the left (default position) vertical dotted line; it can be moved to any place of the screen.

X2 cursor is the right (default position) vertical dotted line; it can be moved to any place of the screen.

Use the **Universal Knob** to set the X1 and X2 cursor values and the values are displayed in the cursors box in the upper-left corner of the screen along with the difference between X1 and X2 (ΔT) and $1/\Delta T$.

When set cursor type to X2-X1, use **Universal Knob** will move the X1 and X2 cursors together. The value under the menu option is the difference between the X1 and X2 cursors.

Y Cursors

Y cursors are horizontal dotted lines that adjust vertically and can be used to measure voltage (V) or current (A). When the cursors source is the math function, the unit will match the math function.

Y1 cursor is the top (default position) horizontal dotted line; it can be moved to any vertical place of the screen.

Y2 cursor is the down (default position) horizontal dotted line; it can be moved to any vertical place of the screen.

Use the **Universal Knob** to set the Y1 and Y2 cursor values and the values are displayed in the cursors box in the top left corner of the screen along with the difference between Y1 and Y2 (ΔY).

When set cursor type to Y2-Y1, use **Universal Knob** will move the Y1 and Y2 cursors together. The value under the menu option is the difference between the Y1 and Y2 cursors.

Make Cursor Measurements

1. Press the **Cursors** button on the front panel to enter the CURSOR function menu.
2. Press the **Mode** softkey and set the cursors mode to **Manual** or **Track**.
3. Press the **Source** softkey, and then use the **Universal Knob** to select the desired source. Only analog channels, math waveforms and reference waveforms that are displayed are available for cursors.
4. Press the **X Ref** and **Y Ref** softkey to set the reference of X cursors and Y cursors.
 - **Position:** when the horizontal/vertical scale is changed, the X/Y cursors remain fixed to the grid position on the display.
 - **Delay/Offset:** when the horizontal/vertical is changed, the value of X/Y cursors remain fixed.
5. To make cursor measurements:
 - To measure the horizontal time, use the **Universal Knob** to move the X1 and X2 cursors to desired place. If necessary, set the cursor type to **X2-X1**, move X1 and X2 cursors together.
 - To measure vertical voltage or current, use the **Universal Knob** to move the Y1 and Y2 cursors to desired place. If necessary, set the cursor type to "Y2-Y1" , move Y1 and Y2 cursors together.
 - To adjust the transparency of the cursors message box, press the **Display/Persist** button and go to the second page, press the **Transparence** (20% to 80%) softkey and then turn the **Universal Knob** to adjust the transparence to the desired value.

Cursor examples:

Use cursors to measure pulse width:

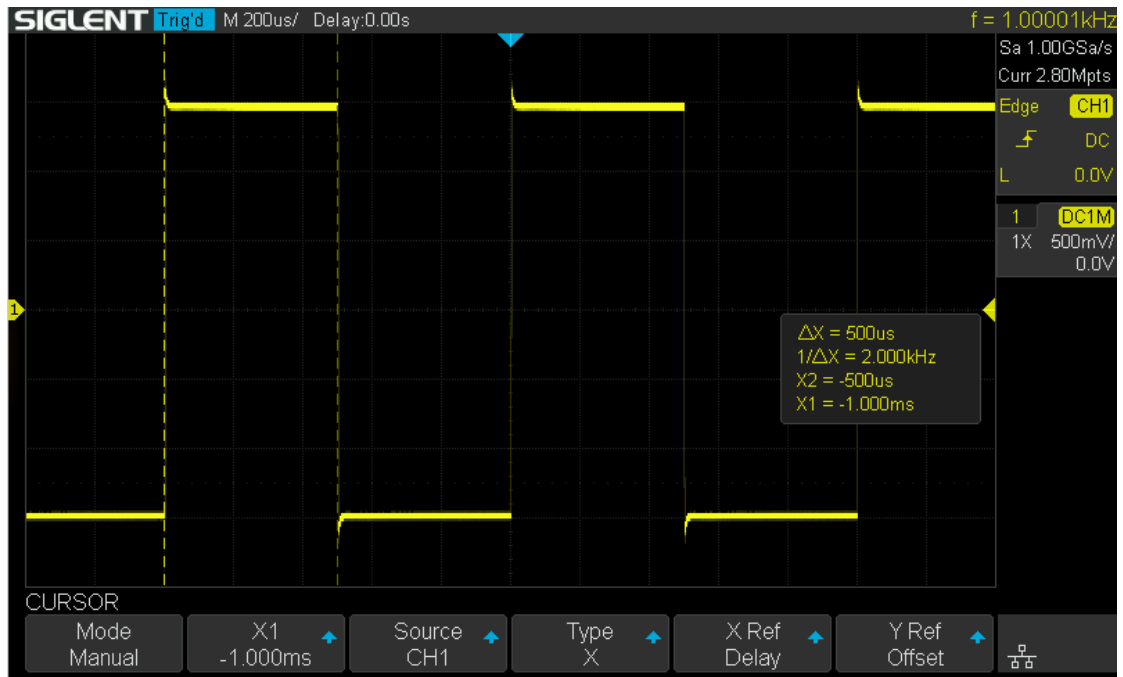

Figure 86 Measure Pulse Width

Measure

The oscilloscope provides measurements of 38 waveform parameters and the statistics. It contains voltage, time and delay parameters.

Voltage and time parameters are under Type option. The results of the last four selected measurements are displayed at the bottom of screen and above the menu. Delay parameters are under the **All Measure** submenu. Set the Delay option to On to display all the delay parameters.

The contents of this chapter:

- ◆ Type of measurement
- ◆ Add measurement
- ◆ Clear measurement
- ◆ All measurement
- ◆ Gate measurement

Type of Measurement

Voltage Measurements

Voltage measurements include 17 kinds of voltage parameter measurements.

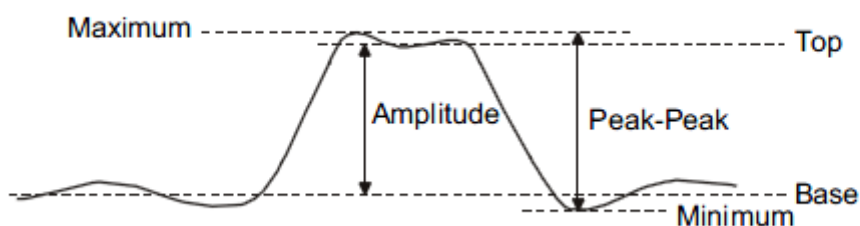

Figure 87 Voltage Measurements

1. **Peak-Peak:** Difference between maximum and minimum data values.
2. **Maximum:** Highest value in input waveform.
3. **Minimum:** Lowest value in input waveform.
4. **Amplitude:** Difference between top and base in a bimodal signal, or between max and min in a unimodal signal.
5. **Top:** Value of most probable higher state in a bimodal waveform.
6. **Base:** Value of most probable lower state in a bimodal waveform.
7. **Mean:** Average of all data values
8. **Cycle mean:** Average of data values in the first cycle.
9. **Stdev:** Standard deviation of all data values
10. **Cycle Stdev:** Standard deviation of all data values in the first cycle
11. **Rms:** Root mean square of all data values.
12. **Cycle RMS:** Root mean square of all data values in the first cycle.
13. **Overshoot:** Overshoot is distortion that follows a major edge transition expressed as a percentage of Amplitude. ROV means rising edge overshoot and FOV means falling edge overshoot.

$$\text{Rising edge overshoot} = \frac{\text{local Maximum} - \text{D Top}}{\text{Amplitude}} \times 100$$

$$\text{Falling edge overshoot} = \frac{\text{Base} - \text{D local Minimum}}{\text{Amplitude}} \times 100$$

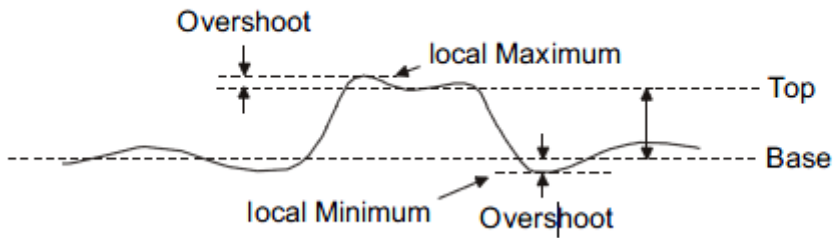

Figure 88 Overshoot

14. **Preshoot:** Preshoot is distortion that precedes a major edge transition expressed as a percentage of Amplitude. The X cursors show which edge is being measured (edge closest to the trigger reference point).

$$\text{Rising edge preshoot} = \frac{\text{local Minimum} - D \text{ Top}}{\text{Amplitude}} \times 100$$

$$\text{Falling edge preshoot} = \frac{\text{Base} - D \text{ local Minimum}}{\text{Amplitude}} \times 100$$

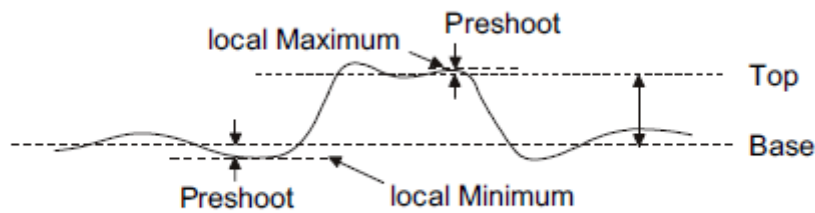

Figure 89 Preshoot

15. **Level@X:** the voltage value between the trigger point and the vertical position of the channel

Time Measurements

Time measurements include 11 kinds of time parameter measurements.

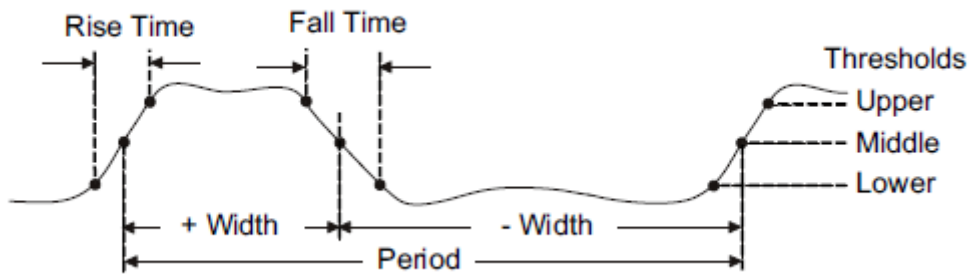

Figure 90 Time Measurements

1. **Period:** Period for every cycle in waveform at the 50% level, and positive slope.
2. **Frequency:** Frequency for every cycle in waveform at the 50% level, and positive slope
3. **+ Width:** Width measured at 50% level and positive slope.
 - **Width:** Width measured at 50% level and negative slope.
4. **Rise Time:** Duration of rising edge from 10-90%.
5. **Fall Time:** Duration of falling edge from 90-10%.
6. **BWid:** Time from the first rising edge to the last falling edge, or the first falling edge to the last rising edge at the 50% crossing.
7. **+ Duty:** Ratio of positive width to period.
 - **Duty:** Ratio of negative width to period.
8. **Delay:** Time from the trigger to the first transition at the 50% crossing.
9. **T@L:** Time from trigger of each transition at a specific level and slope, include: Current, Max, Min, Mean, and Std-dev.

Delay Measurements

Delay measurements measure the time different between arbitrary two channels, including 10 kinds of delay measurements.

1. **Phase:** Calculate the phase difference between two edges.
2. **FRFR:** Time between the first rising edges of the two channels.
3. **FRFF:** Time from the first rising edge of channel A to the first falling edge of channel B.
4. **FFFR:** Time from the first falling edge of channel A to the first rising edge of channel B.
5. **FFFF:** Time from the first falling edge of channel A to the first falling edge of channel B.
6. **FRLR:** Time from the first rising edge of channel A to the last rising edge of channel B.

7. **FRLF:** Time from the first rising edge of channel A to the last falling edge of channel B.
8. **FFLR:** Time from the first falling edge of channel A to the last rising edge of channel B.
9. **FFLF:** Time from the first falling edge of channel A to the last falling edge of channel B.
10. **Skew:** Time of source A edge minus time of nearest source B edge.

Add Measurement

Perform the steps below and select voltage or time parameters to make automatic measurement.

1. Press the **Measure** button on the front panel to enter the MEASURE function menu. At the same, the frequency and period are enabled with the current trigger channel, the statistics also was enabled.
2. Press the **Source** softkey, and then use the **Universal Knob** to select the desired channel. Only analog channels that are displayed are available for measurements.
3. To select and display measurement parameters. Press the **Type** softkey, and then turn the **Universal Knob** to select the desired measurement parameter.
4. Press the **Universal Knob** to add the measurement parameter, the parameters and value will be shown above the menu, and the statistics status will update.
5. To turn off the statistic function, press the **Statistics** softkey to select **Off**.

The measurement display area can display 4 measurement parameters at most, and the measurements will arrange according to the selecting order. If add the fifth measurement parameter, it will delete the first measurement.



Figure 91 Select the Measurement Parameter

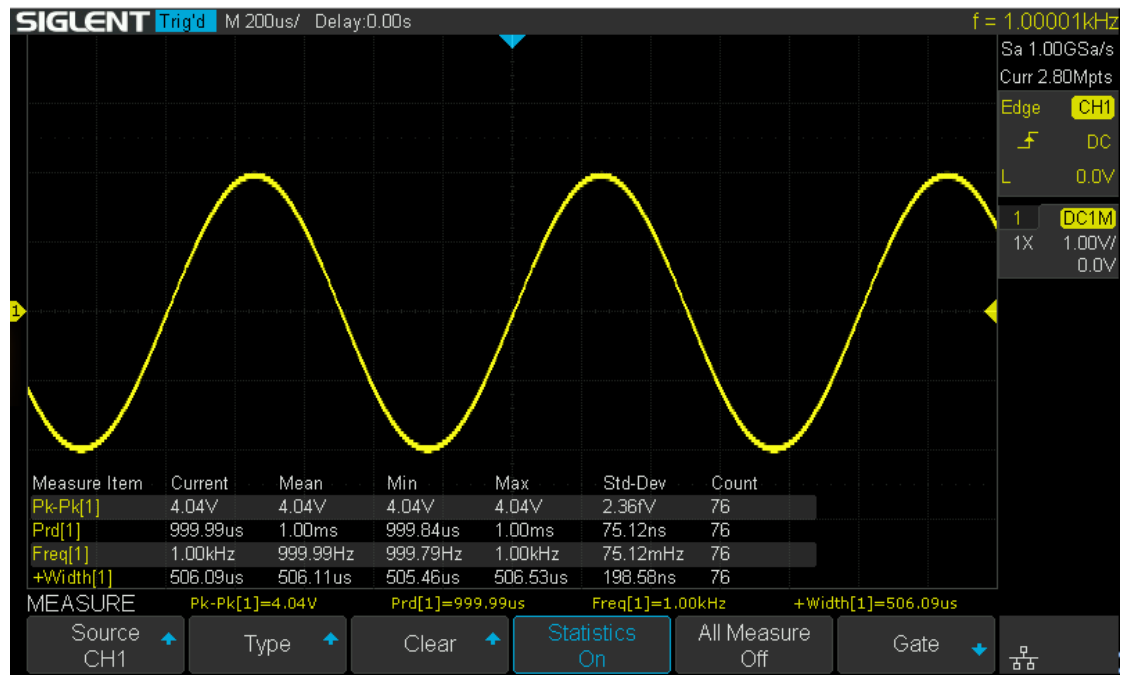

Figure 92 Added the Measurement

Note: if the parameter does not match the measure condition, it will display as "****" .

Clear Measurement

SDS1000X-E (4-channel) supports selective clearing of measurement parameters that are displaying on the screen. SDS1000X-E (2 channel) and SDS1000X-U only support one key to clear all measurement items.

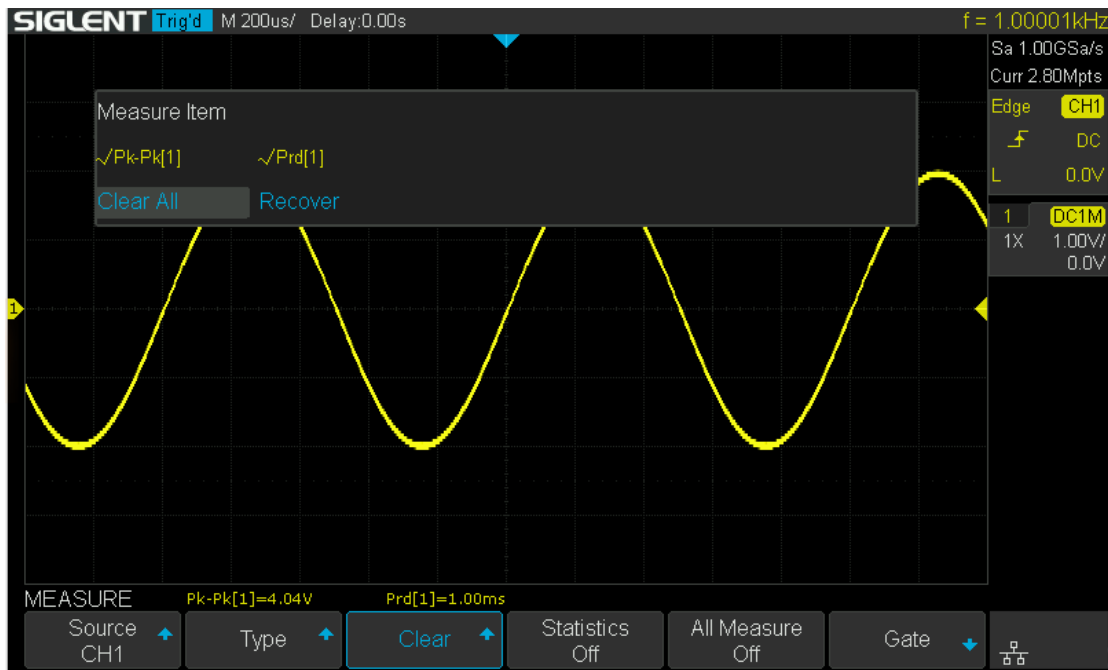

Figure 93 Clear Measurement

Press the **Clear** softkey to call up the clear measurement box. Rotate and press the **Universal Knob** to clear a measurement or all measurement. Press **Recover** to recover the selected measurement.

All Measurement

All measurement could measure all the voltage and time parameters of the current measurement source and display the results on the screen.



Figure 94 All Parameters Measurement

Do the following steps to make all parameters measurement.

1. Press the **Measure** button on the front panel to enter the MEASURE function menu.
2. Press the **All Measure** softkey to select **On**.
3. Press the **Source** softkey to select the measure source.

Gate Measurement

The SDS1000X-E/SDS1000X-U support gate measurement and perform the selected measurement within the upper and lower limits of the gate. Setting the gate will affect the measurement of all voltage, time, and delay parameters.

1. Press **Measure** → **Gate** → **On** to open the gate measurement.
2. Press the **Gate A** to move the position of gate A by the **Universal Knob**.
3. Press the **Gate B** to move the position of gate B by the **Universal Knob**.
4. Press the **Gate A-B** to move the positions of the gate A and B simultaneously by the **Universal Knob**.

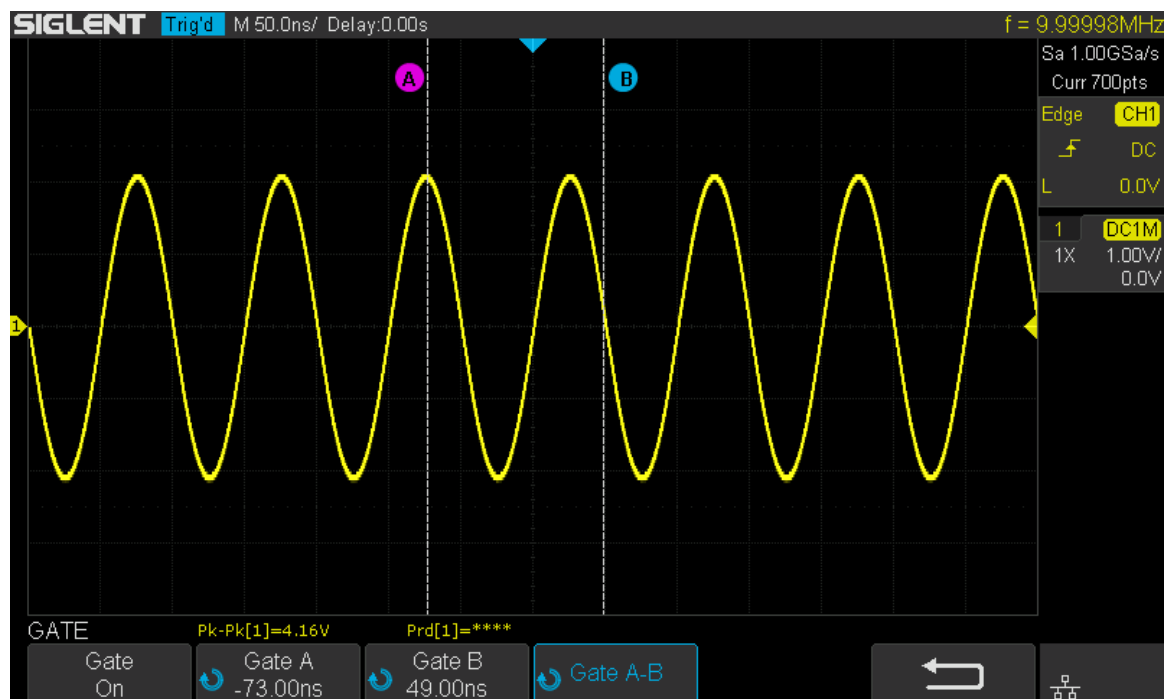

Figure 95 Gate Measurement

Display

You can set the display type, color, persistence, grid type, waveform intensity, grid brightness and transparency.

The contents of this chapter:

- ◆ Display Type
- ◆ Color Grade
- ◆ Persistence
- ◆ Clear the Display
- ◆ Grid Type
- ◆ Intensity
- ◆ Grid Brightness
- ◆ Transparency

Display Type

Press the **Display** button on the front panel, and then press the **Type** softkey to select **Vectors** or **Dots** display type.

- **Vectors:** the sample points are connected by lines and displayed. Normally, this mode can provide the most vivid waveform to view the steep edge of the waveform (such as square waveform).
- **Dots:** display the sample points directly. You can directly view each sample point and use the cursor to measure the X and Y values of the sample point.

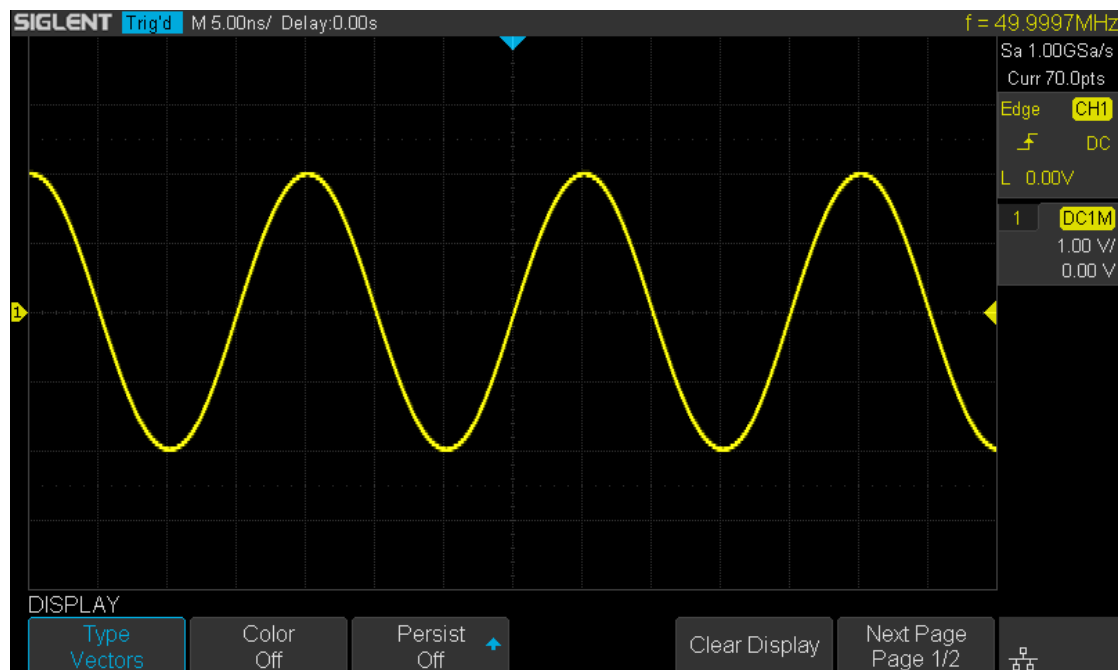

Figure 96 Vectors Display

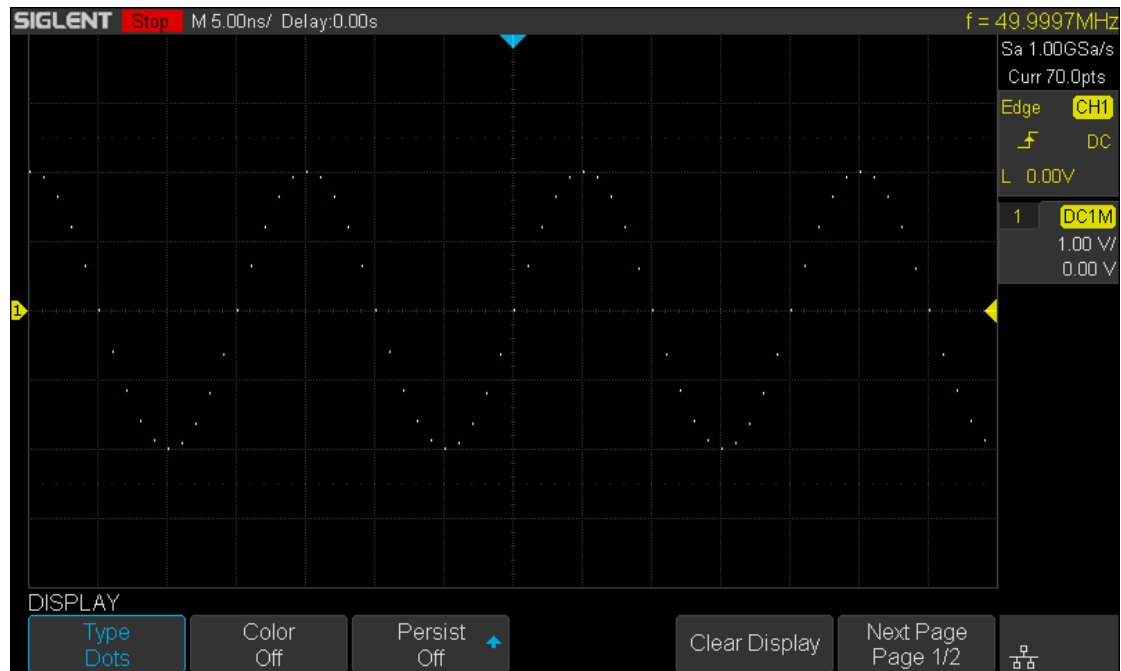

Figure 97 Dots Display

Color Grade

Color temperature adopts the change of waveforms' color to reflect the change of the waveforms' appearing probability. The greater the probability that the waveform appears, the warmer the color is; the smaller the waveform appears, the colder the color is.

The picture below shows the change of color from cold to warm. Press the **Display** button on the front panel, and then press the **Color Grade** softkey and set the option to **On** to turn on the color temperature function. You can compare the waveform's color with the picture below to just the probability that the waveform appears.

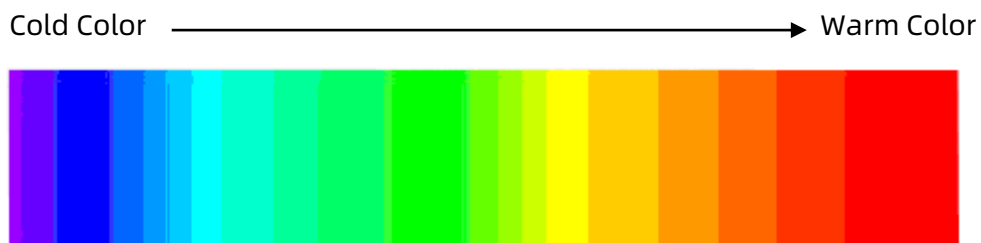

Figure 98 Color Temperature

Persistence

With persistence, the oscilloscope updates the display with new acquisitions, but does not immediately erase the results of previous acquisitions. All previous acquisitions are displayed with reduced intensity. New acquisitions are shown in their normal color with normal intensity.

Do the following steps to set and clear persistence:

1. Press the **Display/Persist** button on the front panel to enter the DISPLAY function menu.
2. Press the **Persist** softkey; then turn the **Universal Knob** to select the desired option.
 - **Off**—turn off persistence.
 - **Variable persistence time** (1 second, 5 seconds, 10 seconds, 30 seconds) — select different persistence time, the results of previous acquisitions are erased after a certain amount of time
 - **Infinite** —select “Infinite” Results of previous acquisitions are never erased. Use infinite persistence to measure noise and jitter, to see the worst- case extremes of varying waveforms, to look for timing violations, or to capture events that occur infrequently.



Figure 99 Persist Set to Infinite

3. When the **Persist** is **On**, to erase the results of previous acquisitions from the display, press the **Clear Persist** softkey. The oscilloscope will start to

accumulate acquisitions again.

4. To return to the normal display mode, turn off persist and the previous acquisitions will be clear at once.

Clear Display

Press the Display button on the front panel to enter the DISPLAY function menu; press the **Clear Display** softkey to clear all the waveforms displaying on the screen and acquire and display new waveforms.

Grid Type

To select grid type

1. Press the **Display/Persist** button on the front panel to enter the DISPLAY function menu.
2. Press the **Next Page** softkey to go to the second page of the Display function menu.
3. Press the **Grid** softkey; and then turn the **Universal Knob** to select the desired grid type. Press the **Grid** softkey continually can also select the grid type.

There are 3 kinds of grid types that are available. Select the grid type according to your really demand.

 Display 14X8 grid type

 Display 2X2 grid type

 Display without grid

Intensity

Do the following steps to adjust waveform intensity:

1. Press the **Display/Persist** button on the front panel to enter the DISPLAY function menu.

2. Press the **Next Page** softkey to go to the second page of the Display function menu.
3. Press the **Intensity** softkey; and then turn the **Universal Knob** to select the desired value. The default value is 50%, and the range is from 0% to 100%.

Increasing the intensity lets you see the maximum amount of noise and infrequently occurring events. Reducing the intensity can expose more detail in complex signals as shown in the following figures.

Note: Waveform intensity adjustment affects analog channel waveforms only (not math waveforms, reference waveforms, digital waveforms, etc.).

Grid Brightness

Do the following steps to adjust the grid brightness:

1. Press the **Display** button on the front panel to enter the DISPLAY function menu.
2. Press the **Next Page** softkey to go to the second page of the Display function menu.
3. Press the **Graticule** softkey; and then turn the **Universal Knob** to select the desired value. The default value is 40%, and the range is from 0% to 100%.

Transparency

Transparency can be used to adjust the transparency of the message box of cursor, measure, Pass/Fail and all pop-up menus to an appropriate value to observe the data more conveniently.

Under Cursor or Measure or any other menu operation, if want to change the transparency of the message box, do the following steps:

1. Press the **Display** button on the front panel to enter the DISPLAY function menu.
2. Press the **Next Page** softkey to go to the second page of the Display function

menu.

3. Press the **Transparence** softkey; and then turn the **Universal Knob** to select the desired value. The default value is 80%, and the range is from 20% to 80%.

Save and Recall

Oscilloscope setups, waveforms, pictures, and CSV files can be saved to internal oscilloscope memory or to a USB storage device. The saved setups, waveforms can be recalled later. The oscilloscope provides an USB Host interface on the front panel to connect an USB device for external storage.

The contents of this chapter

- ◆ Save Type
- ◆ Internal Save and Recall
- ◆ External Save and Recall
- ◆ Disk Management

Save Type

The oscilloscope supports setups, waveforms, images and CSV files storage. The default save type is setups.

1. Setups

It's the default storage type of the oscilloscope. It saves the settings of the oscilloscope in internal or external memory in "*.xml" format. At most 20 setting files (from No.1 ~ No.20) can be stored in internal memory. The stored settings can be recalled.

2. Reference

The oscilloscope saves the waveform data in external memory in "*.REF" format. The data of the channel is you select channel. At recall, the data will be displayed on the screen by REFA or REFB.

3. BMP

The oscilloscope saves the screen image in external memory in "*.bmp" format. You can specify the file name and saving directory under the same directory using the same file name. The recall of image is not supported.

4. JPG

The oscilloscope saves the screen image in external memory in "*.jpg" format. You can specify the file name and saving directory under the same directory using the same file name. The recall of image is not supported.

5. PNG

The oscilloscope saves the screen image in external memory in "*.png" format. You can specify the file name and saving directory under the same directory using the same file name. The recall of image is not supported.

6. Binary

The oscilloscope saves the waveform data in external memory in "*.BIN" format. The data of all the channels turned on can be saved in the same file. The recall of binary is not supported.

7. CSV

The oscilloscope saves the waveform data in external memory in "*.CSV" format. The stored files contain the waveform data of the displayed analog channels and the main setting information of the oscilloscope. The recall of CSV file is not supported.

Set the save type to **CSV**, and set the **Param Save** option to **On** or **Off** to turn on or off of the parameters storage function.

8. Matlab

The oscilloscope saves the waveform data in external memory in “*.DAT” format. The data of all the channels turned on can be saved in the same file. The recall of Matlab file is not supported.

9. To Default Key

The oscilloscope saves the factory config and user set config. Then you can select the default function is the factory config or user set config.

10. FileConverter

The mini tool is used to convert stored binary files to CSV format for viewing with a spreadsheet program. It supports for file of waveform data (*.bin), file of sample logger(*.slg) and file of measure logger (*.mlg) to convert.

This is ideal when collecting large datasets. For a waveform frame with deep memory such as 14 Mpts, to save directly as a CSV file will take long time and will occupy a large amount of memory on a USB storage device. It's recommended to save the data as binary file and then convert it to CSV file on a computer.

Internal Save and Recall

Internal save and recall support Setups in **Save/Recall**. In the following part, the save and recall method and procedures are introduced.

➤ **Save the specified oscilloscope setting in internal memory.**

1. Connect the signal to the oscilloscope and obtain stable display.
2. Press **Save/Recall** button on the front panel to enter the SAVE/RECALL function menu.
3. Press the **Save** softkey to enter the SAVE function menu.
4. Press the **Type** softkey and then turn the **Universal Knob** to select **Setups**; and then press the knob to confirm.
5. Press the **Save to** softkey to select **Internal** to save the current setup of the oscilloscope to the internal memory.
6. Press the **Setup** softkey button; and then turn the **Universal Knob** to select the location to save. The internal memory can save as many as 20 setup files, from No.1 ~ No.20.
7. Press the **Press to Save** softkey to save the current setup to the appointed location. After a few seconds, it will pop-up the message “**Saved to internal file NO.x!**”

➤ **Load the specified type of file in internal memory.**

If want to recall the setup after having finished the steps above, please do the following steps:

1. Press the **Recall** softkey enter the RECALLING function menu.
2. Press the **Type** softkey and then turn the **Universal Knob** to select **Setups**; and then press the knob to confirm.
3. Press the **Recall from** softkey to select **Internal**.
4. Press the **Setup** softkey button; and then turn the **Universal Knob** to select the location to recall. The internal memory can recall as many as 20 setup files, from No.1 ~ No.20.
5. Press the **Press to Recall** softkey to recall the current setup form the appointed location. After a few seconds, it will pop-up the message “**Recalled file successfully!**”

Note: if need to delete a setup file in the memory, please save a new setup to the same location to overwrite it.

External save and recall

Before using external storage and recall, make sure that the USB flash device is connected correctly. External storage supports all the types of files in save, but in recall, images and CSV are not supported.

➤ **Save the specified type of file in the external USB flash device.**

1. Press the **Save/Recall** button on the front panel to enter the SAVE/RECALL function menu.
2. Press the **Save** softkey to enter the SAVE menu.
3. Press the **Type** softkey to select **Setup** and then press the knob to confirm.
4. Press the **Save to** softkey to select External.
5. Press the **Press to Save** softkey to enter the SAVE/RECALL file system.

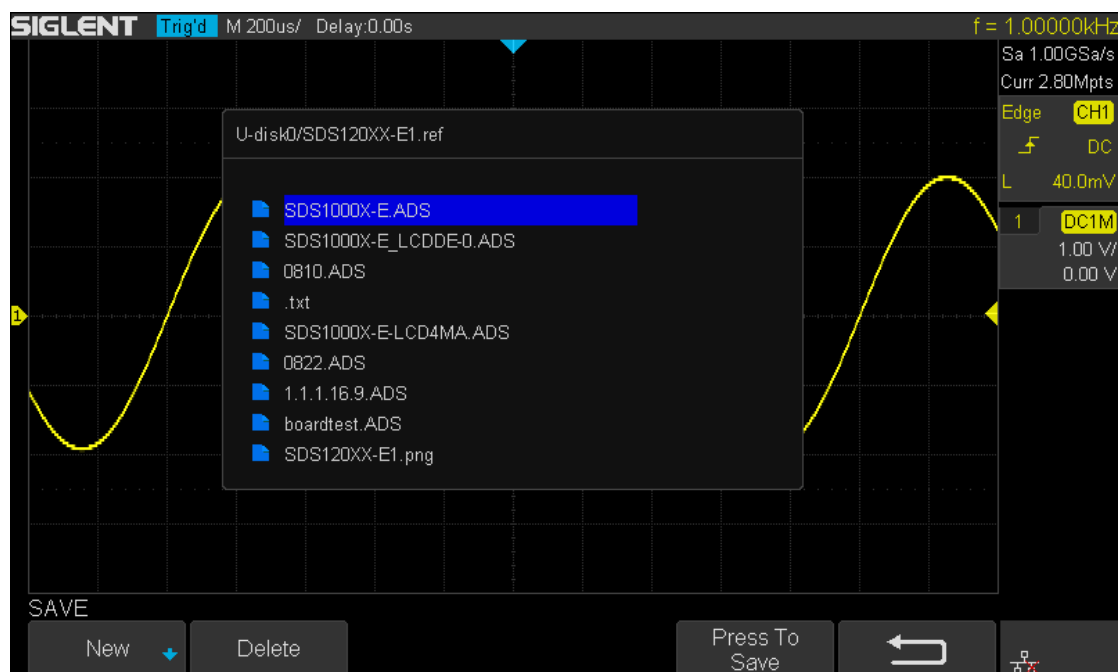

Figure 100 SAVE/RECALL File System

6. Use the **Universal Knob** to select the desired location. File can be stored under the root directory or in a certain folder under the root directory of the USB storage device.

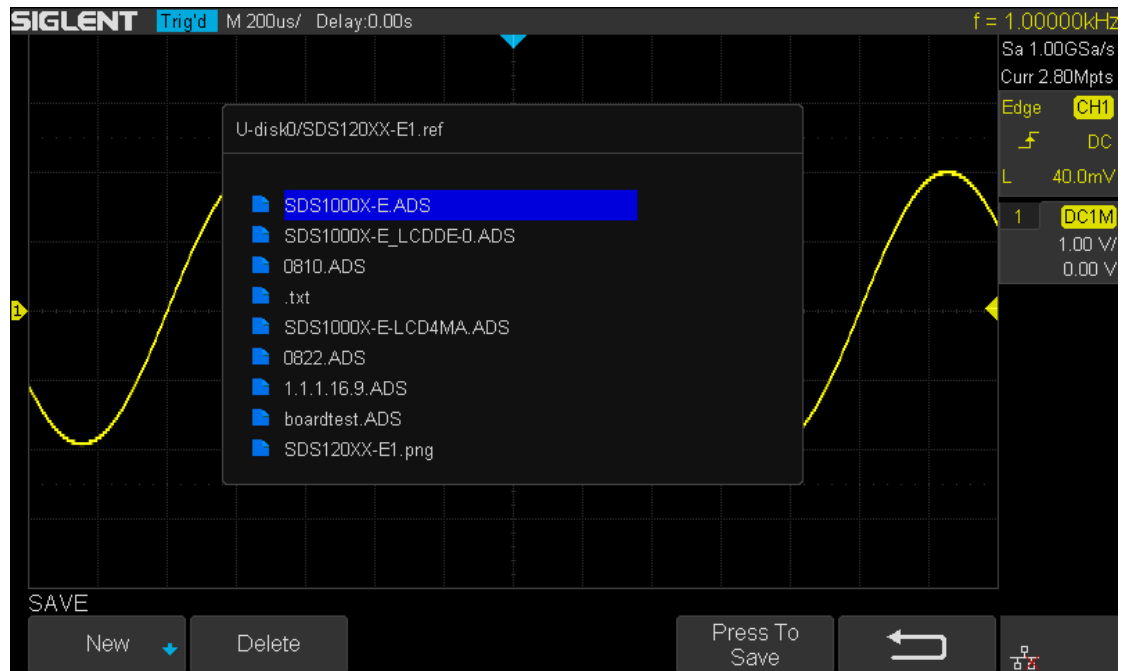

Figure 101 Select Save Location

7. After the save position is selected, press the **New** softkey to turn on the interface as shown in the figure below. Refer to the descriptions in “**To Create a new file or fold**” to create a new file name.

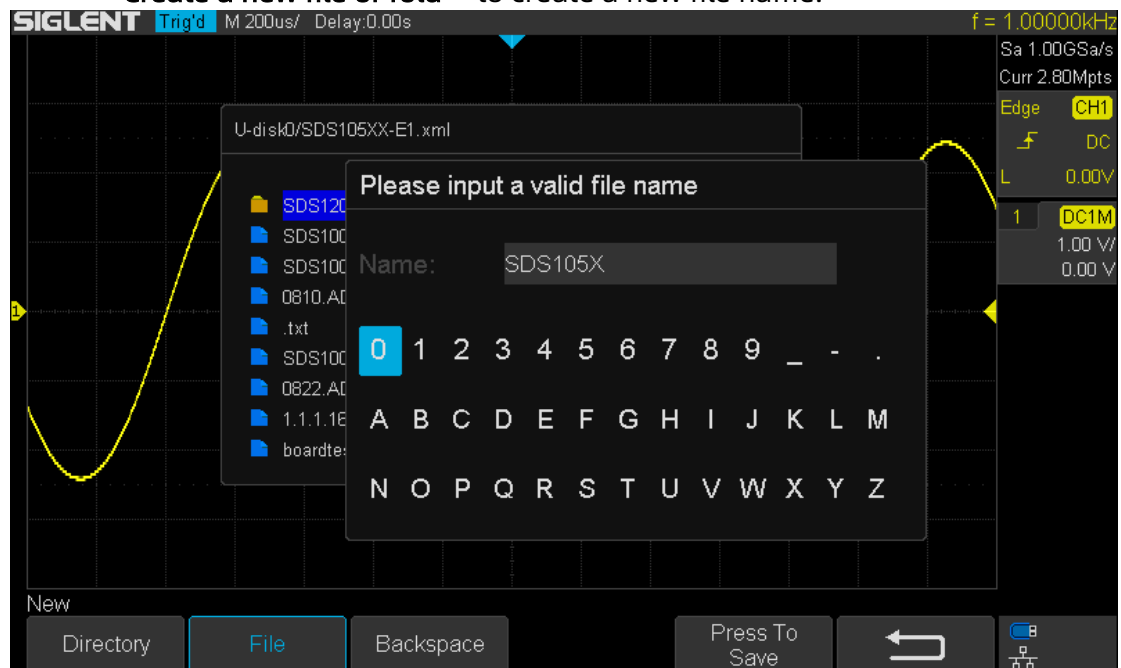

Figure 102 File Name Dialogue

8. Press the **Press to Save** softkey to save the current setup to the external USB storage device.

- **Load the specified type of file in the external USB storage device.**
1. Press the **Save/Recall** button on the front panel to enter the SAVE/RECALL function menu.
 2. Press the **Recall** softkey to enter the RECALL menu.
 3. Press the **Type** softkey to select **Setups** or **Reference**.
 4. Press the **Recall from** softkey to select **External**.
 5. Press the **Press to Recall** softkey to enter the SAVE/RECALL file system.
 6. Turn the **Universal Knob** to select the file to be recalled, press the **Press to Recall** softkey to recall the reference or setup.

Disk Management

Disk management aim at the save and recall operations after the oscilloscope is connected with a USB storage device. Before using external disk, make sure that the USB storage device is connected correctly.

Execute the following operations through the disk management menu:

- ◆ Create a New File or Folder
- ◆ Delete a File or Folder
- ◆ Rename a File or Folder

Create a New File or Folder

This operation is only valid in external storage. The oscilloscope supports English input method. The file name or folder name can contain letters, numbers, underscores and spaces. Let's use an example to introduce how to create a file or folder.

Example: create a file or folder named "SDS105X"

1. Press the **Save/Recall** button on the front to enter the SAVE/RECALL function menu.
2. Press the **Save** softkey, and then turn the **Universal Knob** to select one of the type (if select **Setups**, please set the **Save to** option to **External**).
3. Press the **Press to Save** softkey to enter the SAVE/RECAL file system.
4. Press the **New** softkey to open the interface shown as the figure below. It divides into two parts: name input area and keyboard area.



Figure 103 Input Keyboard

5. To delete the name in the name input area, press the **Backspace** softkey continuously to delete the character one by one.

Delete a File or Folder

This operation is only valid in external storage.

1. Press the **Save/Recall** button on the front to enter the SAVE/RECALL function menu.
2. Press the **Save** softkey, and then turn the **Universal Knob** to select one of the type (if select Setups, please set the **Save to** option to **External**).
3. Press the **Press to Save** or **Press to Recall** softkey to enter the SAVE/RECAL file system.
4. Turn the **Universal Knob** to select the file or folder to be deleted, and then press the **Delete** softkey. Then the file or folder will be deleted.

Rename a File or Folder

This operation is only valid with external storage (U disk storage), and only files of the corresponding type format can be renamed.

1. Press the **Save/Recall** button on the front to enter the SAVE/RECALL function menu.
2. Press the **Save** softkey, and then turn the **Universal Knob** to select one of the type (if select Setups, please set the **Save to** option to **External**).
3. Press the **Press to Save** or **Press to Recall** softkey to enter the SAVE/RECAL file system.
4. Turn the **Universal Knob** to select the file or folder to be rename, and then press the **Rename** softkey. For details, see the instructions in "Create a New File or Folder."

Digital Channels(Optional)

This chapter describes how to use the digital channels of a Mixed-Single Oscilloscope (MSO).

The digital channels are enabled on SDS1000X-E (4-channel scope) that have installed the MSO activation license. As an external module, SLA1016 is independent of the host, and has its own system, so it needs to be upgraded if necessary.

This chapter contains the following items:

- ◆ Connect the Digital Probes
- ◆ Acquire Digital Waveform
- ◆ Digital Channels Height
- ◆ Digital Channels Position
- ◆ Single Digital Channel
- ◆ All Digital Channels
- ◆ Logic Threshold
- ◆ Digital Bus
- ◆ Deskew
- ◆ System Setting
- ◆ Remove Device

Connect the Digital Probes

1. If necessary, turn off the power supply to the device-under-test.
 - Turning off the power to the device-under-test prevents damage that might occur if you accidentally short lines together while connecting probes. You can leave the oscilloscope powered on because no voltage appears at the probes.
2. Connect one of the digital probe cable ports to the digital channels connector on the front panel of the SDS1000X-E, and the other one to the digital channels connector of the digital probe.
 - The digital probe cable is keyed so you can connect it only one way. You do not need to power-off the oscilloscope.
3. Connect a fly line to one of the digital probe ground pins, connect a grabber to the fly line, and then connect the grabber to a ground trace/pin from the device-under-test. The ground lead improves signal fidelity to the oscilloscope, ensuring accurate measurements,
4. Connect a fly line to one of the digital probe digital channel pins; connect a grabber to the fly line, and then connect the grabber to a node in the circuit you want to test.
5. Repeat step 4 until you have connected all points of interest.

Note:

There are two indicators on the side of the SLA1016, one is red (Power), another is green (Ready)

- The red indicator: If SLA1016's power is normal, this indicator turns on, or else it blinks or turns off.
- The green indicator: When the SLA1016 is connect to the oscilloscope, this indicator turns on for seconds then turns off, and then blinks, and finally keeps the light on. When data is transferred between the SLA1016 and the oscilloscope, the indicator blinks.

Acquire Digital Waveform

Press the **Digital** button on the front panel to open the digital channels and start acquiring digital channel waveforms.

For digital channels, each time the oscilloscope takes a sample it compares the input voltage to the logic threshold. If the voltage is above the threshold, the oscilloscope stores a 1 in the sample memory; otherwise, it stores a 0.

Digital Channels Height

1. Press the **Digital** button on the front panel to open the DIGITAL function menu.

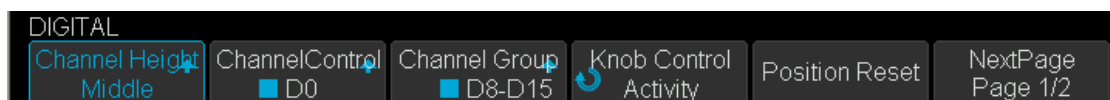

Figure 104 Digital Function Menu

2. Press the **Channel High** softkey to select **Low**, **Middle**, **High** display type.

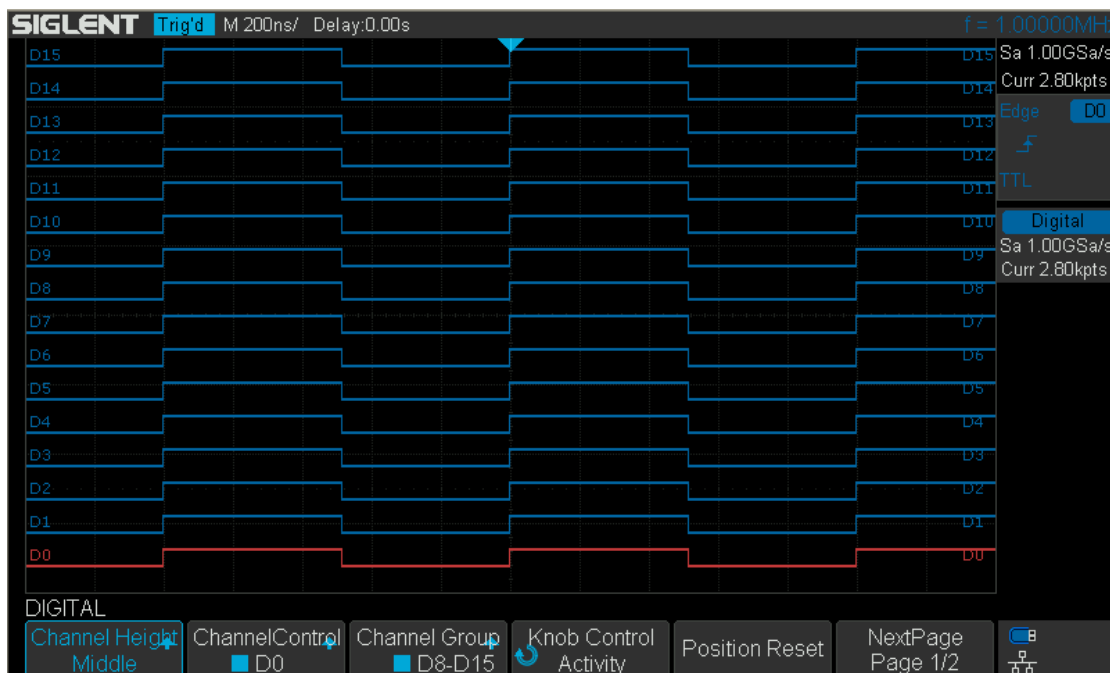

Figure 105 Middle Display Type

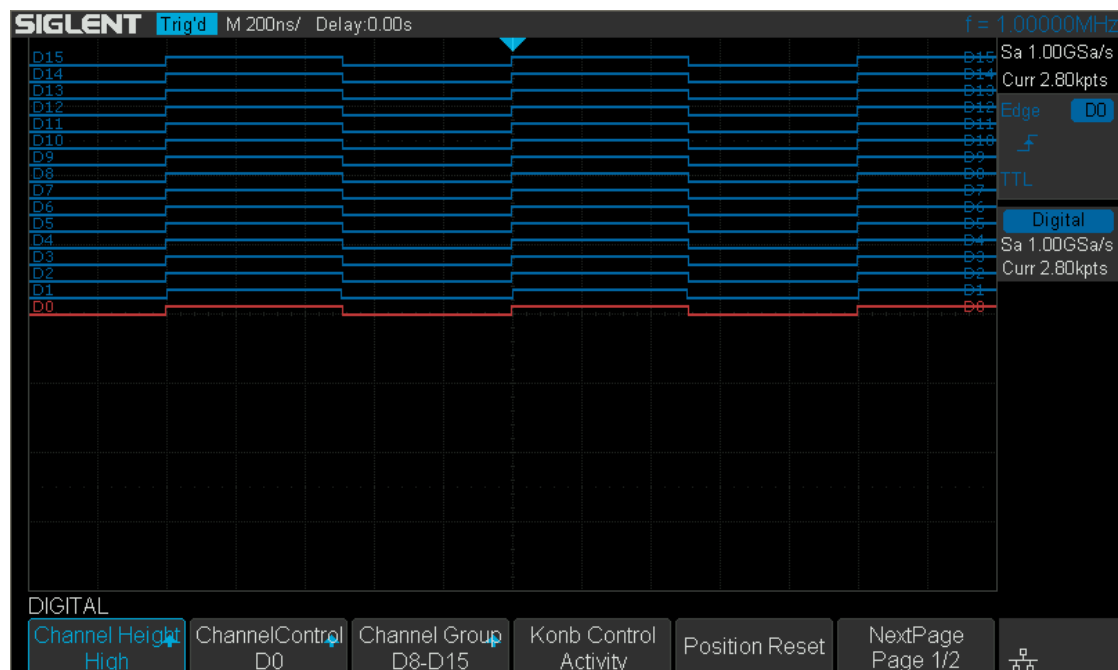

Figure 106 High Display Type

The display type control lets you spread out or compress the digital traces vertically on the display for more convenient viewing.

Digital Channels Position

1. Press the **Digital** button on the front panel to open the DIGITAL function menu and display the digital channel waveforms.
2. Press the **Control** softkey select the Active then turn the **Universal Knob** to select the channel that you wish to reposition. The selected waveform is highlighted in red.
3. Press the **Control** softkey select the Position then turn the **Universal Knob** to move the selected channel to any position.

Single Digital Channel

1. Press the **Digital** button on the front panel to open the DIGITAL function menu.
2. Press the **Channel Control** softkey, then turn the **Universal Knob** to select the desired channel such as **Dx** and push down the knob to confirm.

- Press the **Dx** softkey to select **On** or **Off** to switch the selected channel on or off.

All Digital Channels

- Press the **Digital** button on the front panel to open the DIGITAL function menu.
- Press the **Channel Group** softkey to select **On** or **Off** to switch all digital channels which in this group on or off.

Also, under the DIGITAL function menu, press the **Digital** button on the front panel to switch all digital channels off.

Logic Threshold

- Press the **Digital** button on the front panel to open the DIGITAL function menu.
- Press the **Threshold** softkey to enter the THRESHOLDS menu.
- Press the **D0~D7** or **D8~D15** softkey, then turn the **Universal Knob** to select a logic family preset or select Custom to define your own threshold.

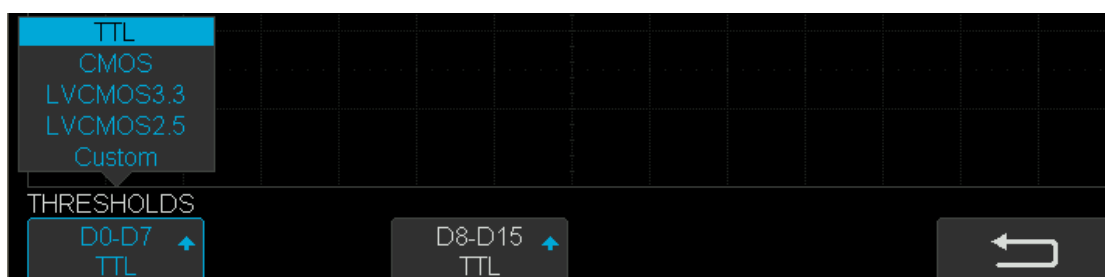

Figure 107 THRESHOLDS Function Menu

Logic Family	Threshold Voltage
TTL	1.5V
CMOS	1.65V
LVCMOS3.3	1.65V
LVCMOS2.5	1.25V
Custom	Variable from -3V to +3V

- The threshold you set applies to all channels.
- Values greater than the set threshold are high (1) and values less than the set threshold are low (0).
- If the **D0~D7** or **D8~D15** softkey is set to **Custom**, press the **Custom** softkey, then turn the **Universal Knob** to select the desired value and push down the knob to confirm.

Digital Bus

Digital channels may be grouped and displayed as a bus, with each value displayed at the bottom of the display in hex or binary. You can create up to two buses.

To configure and display each bus, do the following steps:

1. Press the **Digital** button on the front panel to open the DIGITAL function menu and display the digital channel waveforms.
2. Press the **Digital Bus** softkey to enter the DIGITALBUS function menu.

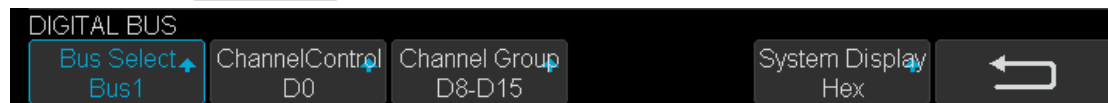

Figure 108 DIGITALBUS Function Menu

3. Press the **Bus Select** softkey to select **Bus1** or **Bus 2**.
4. Press the **Display** softkey to select **On** to display the bus at the bottom of the display.
 - Under the DIGITAL function menu, press the **Channel Control** softkey, turn the **Universal Knob** to select such as **DX**, and then press the **Dx** softkey to select **On** or **Off** to set the channel to be included or excluded in the bus.
 - Under the DIGITAL function menu, press the **Channel Group** softkey to select **On** or **Off** to include or exclude all digital channels in this group.
 - Under the DIGITAL function menu, a status indicator is displayed in the status line at the bottom of the display. Light blue shows the digital channel is included in the bus while black shows it is excluded in the bus.
 - Under the DIGITAL function menu, press the **System Display** softkey to select **Binary** or **Hex** to display the bus values.

The Sampling rate of digital channels is displayed at the right of the display.

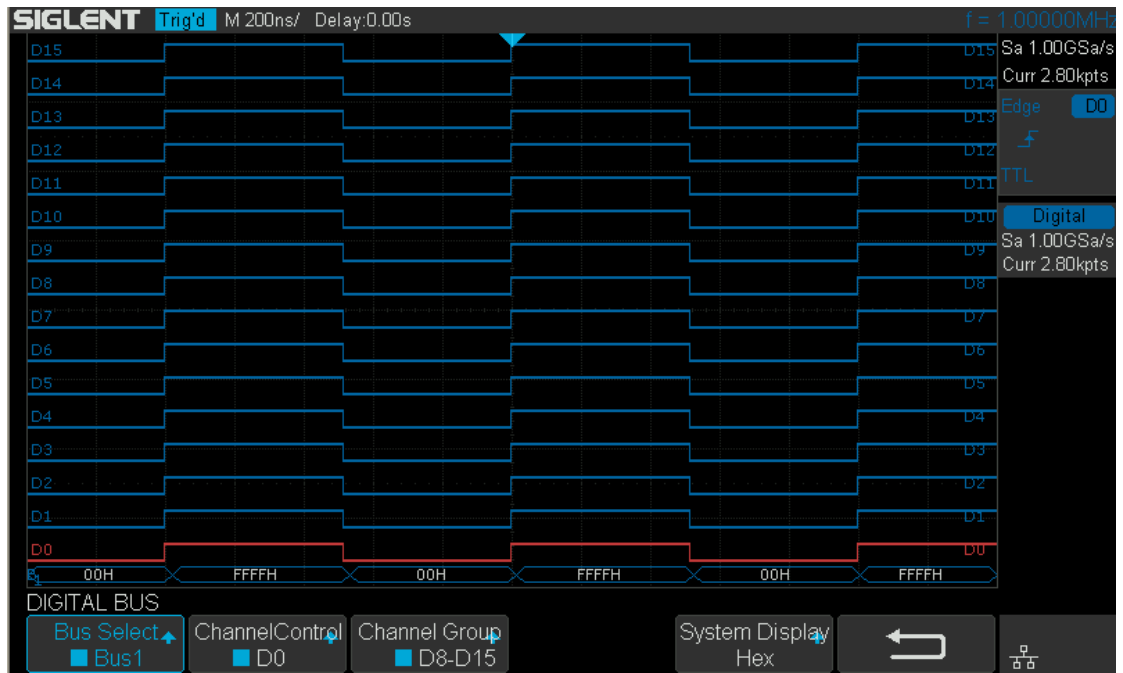

Figure 109 Digital Bus

Deskew

1. Press the **Digital** button on the front panel to open the DIGITAL function menu and display the digital channel waveforms.
2. Press the **Deskew** softkey, and then turn the **Universal Knob** to select to change deskew.

System Setting

System Status

Press **Digital** → **NextPage2/2** → **System**, then select the System Status option to view the digital system information, including software version, hardware version, and serial number. After finished, press the **return** soft key to quit the interface of system information.

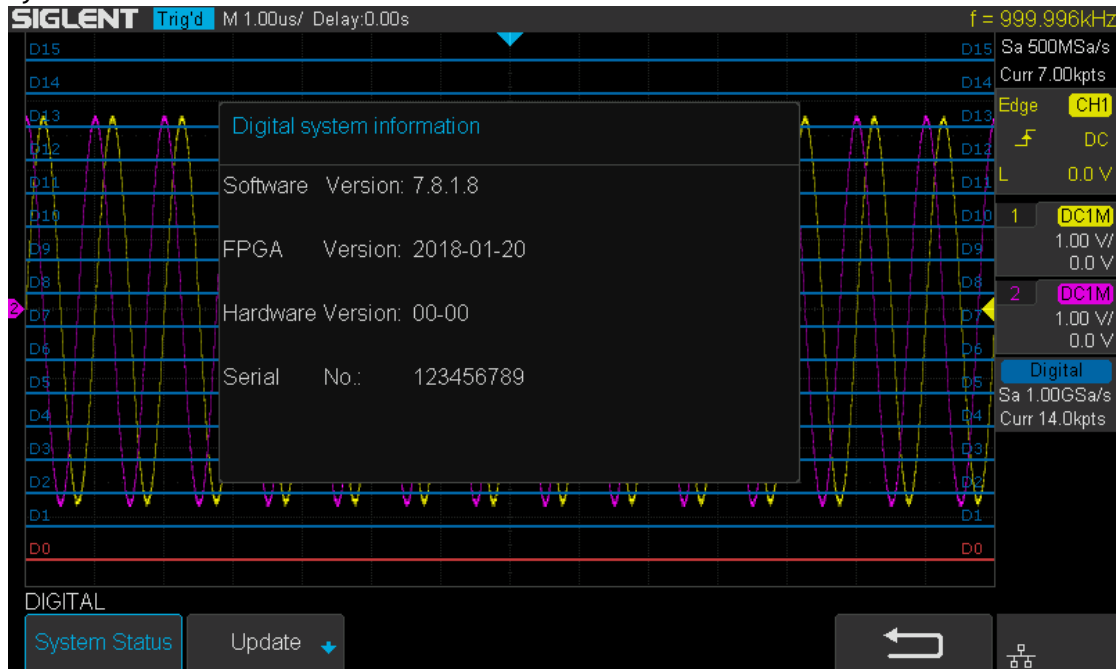

Figure 110 Digital System Information Interface

Update

The software version file of the Digital can be updated directly via U-disk. Follow the steps below:

1. Insert U-disk with firmware update file (*.ads) to USB host interface on the front panel of the oscilloscope. Then a message "USB Flash Drive detected!" will be displayed.
2. Press **Digital** → **NextPage2/2** → **System** → **Update**
3. Expand the U disk directory, Select the firmware file (*.ads), then press the **Press to update**, an upgrade progress bar will be display on the interface.

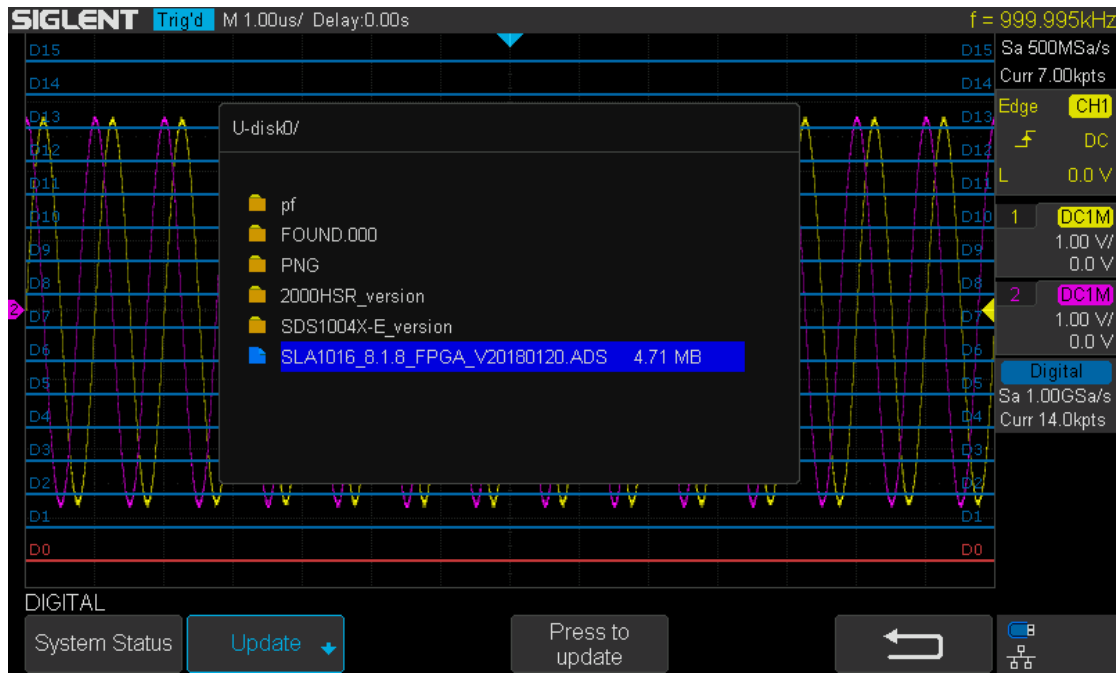

Figure 111 Digital Update Interface

4. After the updating is finished, the Digital device will automatically disconnected and display a message **“Update completed, please reconnect Digital device!”**

Note: Don't cut off the power during the Digital device is being updated!

Remove Device

Press **Digital** → **NextPage2/2** → **Remove Device** and the oscilloscope interface display "Digital device removed!", the device can be pulled.

System Setting

This function module supports the oscilloscope's system-related function, such as system status, language, sound and some other advanced setting, such as do self-cal, update and remote interface configure.

The contents of this chapter:

- ◆ View System Status
- ◆ Do Self Cal
- ◆ Quick-Cal
- ◆ Sound
- ◆ Language
- ◆ Pass/Fail Test
- ◆ Arbitrary Waveform Generator(Optional)
- ◆ IO Set
- ◆ Web Server
- ◆ Counter
- ◆ Data Logger
- ◆ Update Firmware and configuration
- ◆ Do self-Test
- ◆ Screen Saver
- ◆ Date/Time
- ◆ Reference Position
- ◆ Power On Line
- ◆ Option Management

View System Status

Do the following steps to view the system status:

1. Press the **Utility** button on the front to enter the UTILITY function menu.
2. Press the **System Status** softkey to view the system status of the oscilloscope.

The system status includes the information below:

- **Startup Times:** record the boot-strap times of the oscilloscope.
- **Software Version:** list the current software version of the oscilloscope.
- **Uboot-OS Version:** list the current Uboot and OS version of the oscilloscope.
- **FPGA Version:** list the current fpga version of the oscilloscope.
- **Hardware Version:** list the current hardware version of the oscilloscope.
- **Product Type:** display the product type of the oscilloscope.
- **Serial No.:** list the serial number of the oscilloscope.



Figure 112 System Status

3. Press the **Single** button on the front panel to exit.

Do Self Cal

The self-calibration program can quickly make the oscilloscope reach the best working state to get the most precise measurement values. You can perform self-calibration at any time especially when the change of the environment

temperature is up to or more than 5 °C. Make sure that the oscilloscope has been warmed up or operated for more than 30 minutes before the self-calibration.

Do the following steps to do self-calibration:

1. Disconnect all the input channels.
2. Press the **Utility** button on the front panel, and then press the **Do Self Cal** softkey, and the oscilloscope will pop-out the message box shown as below:

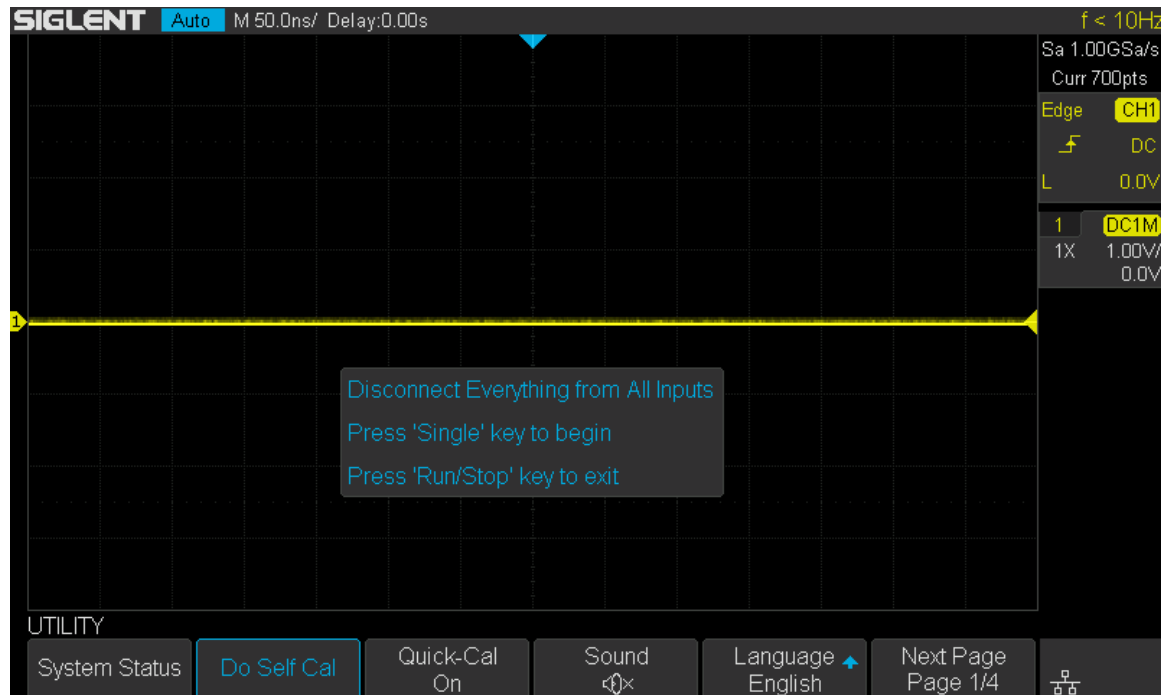

Figure 113 Do Self Cal

3. Press the Single button on the front panel to perform the self-calibration program. During the calibration, most of the keys are disabled.
4. When the self-calibration program is finished, it will pop-out the message “Press Run/Stop key to exit” . Press the **Run/Stop** button on the front panel to exit the calibration interface.

Quick-Cal

Quick calibration can correct the measurement deviation caused by temperature, so that you can get more accurate measurements.

If the ambient temperature of your current operating oscilloscope is unstable, press **Utility** → **Quick-Cal** softkey to select **On** to enable quick calibration.

Sound

When the sound is enabled, you can hear the sound of the beeper when you press a function key or a menu softkey or when the prompt message pops up.

Press the **Utility** button on the front panel to enter the UTILITY function menu; then press **Sound** softkey to select  or  to turn on or off the sound.

Language

The oscilloscope supports multiple language menu, Chinese/English help and prompt messages.

1. Press the **Utility** button on the front panel to enter the UTILITY Function menu.
2. Press the **Language** softkey; and then turn the **Universal Knob** to select the desired language. Then push down the knob to select the language.

The languages that currently available are Simplified Chinese, Traditional Chinese, English, French, German, Spanish, Russian, Italian, and Portuguese.

Pass/Fail Test

One way to verify a waveform's compliance to a particular set of parameters is to use pass/fail testing. A pass/fail defines a region of the oscilloscope's display in which the waveform must remain in order to comply with chosen parameters. Compliance to the mask is verified point- by- point across the display.

The test results can be displayed on the screen as well as be declared through the system sound or the pulse signal output from the [TRIG OUT] connector at the rear panel. Pass/Fail test operates on displayed analog channels; it does not operate on channels that are not displayed.

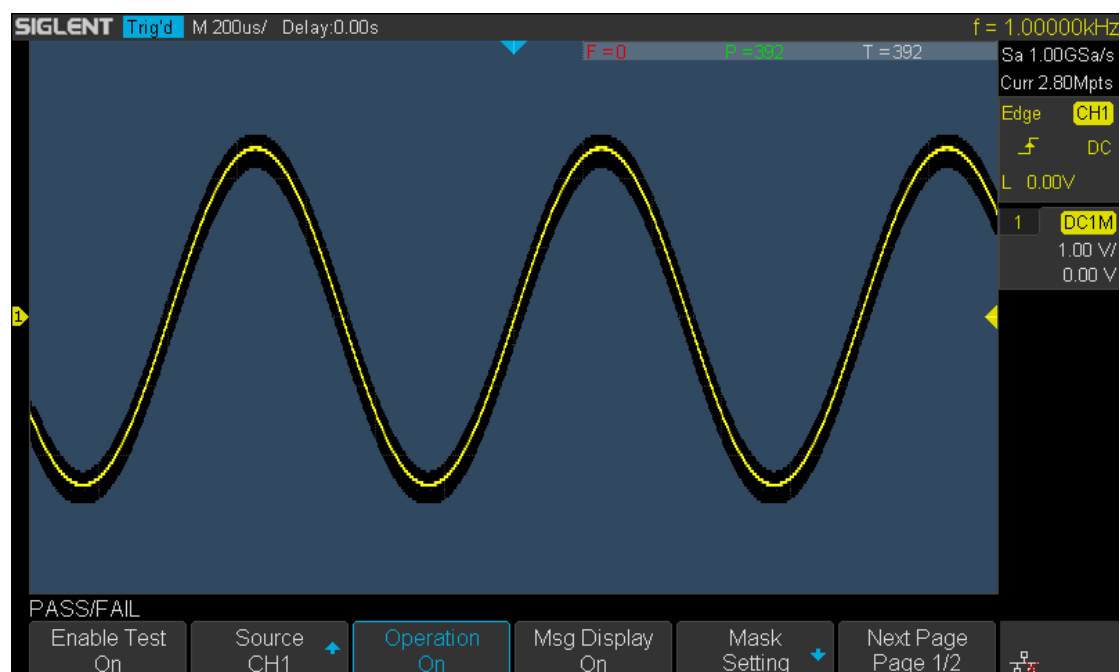

Figure 114 Pass/Fail Test





Set and Perform Pass/Fail Test

Do the following steps to set and perform pass/fail test:

1. Press the **Utility** button on the front panel to enter the UTILITY function menu.
2. Press the **Next Page** softkey to go to the second page of the UTILITY function menu.
3. Press the **Pass/Fail** softkey to enter the PASS/FAIL function menu.
4. Press the **Enable Test** softkey to select **On** to enable the pass/ fail test.
5. Press the **Source** softkey to select the desired channel.

6. Press the **Mask Setting** softkey to enter the MASK function menu.
7. Press the **X Mask** or **Y Mask** softkey; and then turn the **Universal Knob** to select the desired value. The range is from 0.02div to 4div.
8. Press the **Create Mask** button to create the mask. Whenever the **Create Mask** softkey is pressed the old mask is erased and a new mask is created.
9. Press the **UP** softkey to return to the PASS/FAIL function menu.
10. Press the **Msg Display** to select **On** or **Off** to turn on or off the message display. When **On** is selected, the test result will be displayed in the upper-right message box of the screen.

F = 271 P = 344 T = 615

- **F**: the frame number of the channel waveform that fails to match the mask.
 - **P**: the frame number of the channel waveform that matches the mask.
 - **T**: the frame number of the channel waveform that have been acquired. It is the total of **Pass** and **Fail**.
11. Press the **Next Page** softkey to go to the second page of the PASS/FAIL function menu.
 12. Press the **Stop On Fail** softkey to select **On** or **Off** to turn on or off the function.
 - **On**: when failed waveforms are detected, the oscilloscope will stop the test and enter the STOP state. At this point, the results of the test remain the same on the screen (if display is turned on) and only one pulse is output from the **[TRIG OUT]** connector (if enabled) at the rear panel.
 - **Off**: the oscilloscope will continue with the test even though failed waveforms are detected. The test results on the screen will update continuously and a pulse will be output from the **[Trigger Out]** connector at the rear panel each time a failed waveform is detected.
 13. Press the **Output** softkey to select turn on or off the sound.
 -  : When the failed waveforms are detected, the beeper sounds.
 -  : The beeper will not sound even if the failed waveforms are detected,
 14. Press the Next Page softkey to return to the first page of the PASS/FAIL function menu.
 15. Press the **Operate** softkey to perform the test.
 -  : Current state is stop; press the softkey to start the pass/fail test.
 -  : Current state is running; press the softkey to stop the pass/fail test.

Save and Recall Test Mask

Users can save the current test mask to the internal Flash memory or external USB flash device. The file format of the test mask file is `"*.msk"` .

Save Test Mask to Internal Memory

1. Press the **Utility** button on the front panel to enter the UTILITY function menu.
2. Press the **Next Page** softkey to go to the second page of the UTILITY function menu.
3. Press the **Pass/Fail** softkey to enter the PASS/FAIL function menu.
4. Press the **Enable Test** softkey to select **On** to enable the pass/ fail test.
5. Press the **Source** softkey to select the desired channel.
6. Press the **Mask Setting** softkey to enter the MASK function menu.
7. Press the **X Mask** or **Y Mask** softkey; and then turn the **Universal Knob** to select the desired value.
8. Press the **Location** softkey to select **Internal**
9. Press the **Save** softkey to save the mask to internal memory.
10. A few second later, it will pop-out the message **“Save to file Pass/Fail_mask_data.msk!”**

Note: the internal memory can only save one test mask; save a new test mask will cover the old one.

Recall Test Mask from Internal Memory

1. Press the **Utility** button on the front panel to enter the UTILITY function menu.
2. Press the **Next Page** softkey to go to the second page of the UTILITY function menu.
3. Press the **Pass/Fail** softkey to enter the PASS/FAIL function menu.
4. Press the **Enable Test** softkey to select **On** to enable the pass/ fail test.
5. Press the **Mask Setting** softkey to enter the MASK function menu.
6. Press the **Location** softkey to select **Internal**.
7. Press the **Load** softkey to recall the saved interval memory.
8. A few second later, it will pop-out the message **“Recalled the Successfully!”** and the saved mask will be displayed on the screen.

Save Test Mask to External Memory

Do the following steps to save the test mask to external memory:

1. Press the **Utility** button on the front panel to enter the UTILITY function menu.
2. Press the **Next Page** softkey to go to the second page of the UTILITY function menu.
3. Press the **Pass/Fail** softkey to enter the PASS/FAIL function menu.

4. Press the **Enable Test** softkey to select **On** to enable the pass/ fail test.
5. Press the **Source** softkey to select the desired channel.
6. Press the **Mask Setting** softkey to enter the MASK function menu.
7. Press the **X Mask** or **Y Mask** softkey; and then turn the **Universal Knob** to select the desired value.
8. Press the **Location** softkey to select **External**
9. Press the **Save** softkey to enter the file SAVE/RECALL system.
10. Save the test mask file refer to the “**Save to file XXX.msk**” chapter.

Recall Test Mask from External Memory

Do the following steps to save the test mask f external memory:

1. Press the **Utility** button on the front panel to enter the UTILITY function menu.
2. Press the **Next Page** softkey to go to the second page of the UTILITY function menu.
3. Press the **Pass/Fail** softkey to enter the PASS/FAIL function menu.
4. Press the **Enable Test** softkey to select **On** to enable the pass/ fail test.
5. Press the **Mask Setting** softkey to enter the MASK function menu.
6. Press the **Location** softkey to select **External**.
7. Press the **Load** softkey to enter the file SAVE/RECALL system.
8. Select the desired test mask file with a RGU postfix using the **Universal Knob**; and then press the **Load** softkey.

Arbitrary Waveform Generator(Optional)

SDS1000X-E (4-channel) support an external Arbitrary Waveform Generator (AWG), which can easily and quickly provide multiple input signals to users.

The AWG provides two kinds of waveforms: the standard waveform and the Arb. The Arb single consists of two types: the system's built-in waveforms and the stored waveforms.

Built-in waveforms are stored in the internal non-volatile memory. It includes: Common, Math, Engine, Window, and Trigo. Users may also edit the arbitrary waveform by PC which has installed the EasyWave, or import the waveform by U disk that had stored edited waveform.

The contents of this chapter:

- ◆ Output
- ◆ Wave
- ◆ Setting
- ◆ System
- ◆ Remove Device

Output

Connect AWG with USB cable, and the oscilloscope interface indicates "AWG device connection success", Press the **Utility** → **Next Page4/4** → **AWG**, to enter the function menu interface of the AWG system as shown below, including: Output, Wave, Setting, System, and Remove Device.



Figure 115 AWG Menu Interface

Press **Output** softkey to open or close the AWG output .When the output is on, the upper right corner of the oscilloscope interface will displays the corresponding waveform frequency and amplitude information of AWG output wave.

Wave

To set standard waveform

Press the **Utility** → **Next Page4/4** → **AWG** → **Wave Type**, Rotate the **Universal Knob** to the Sine wave. Then press the knob to select the interface shown as below:

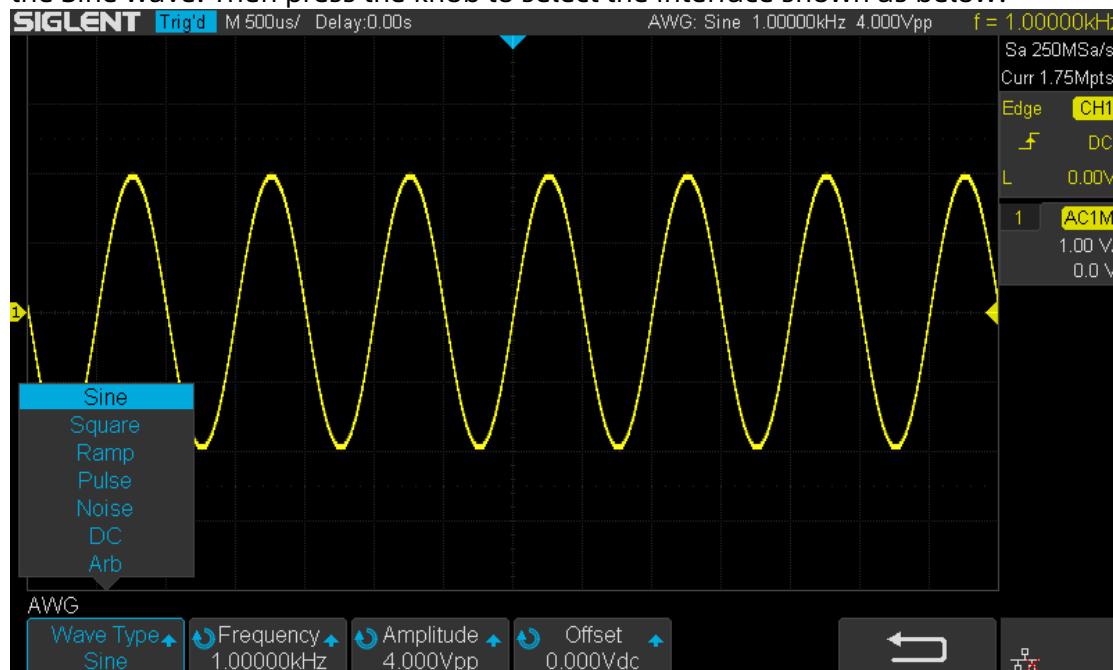

Figure 116 Wave Type Interface

The following table shows the waveform type and its corresponding characteristics.

According to the selected waveform, to set the waveform parameters through **Universal Knob** and the corresponding function software under the menu.

Wave Type	Parameters	Frequency Range	Amplitude (High-Z)	Offset (High-Z)
Sine	Frequency/Period/Amplitude/High-Level/Offset/Low-Level value.	1uHz~25MHz	4mV~6V	± 3.0V
Square	Frequency/Period/Amplitude/High-Level/Offset/Low-Level/Duty value.	1uHz~10MHz	4mV~6V	± 3.0V
Ramp	Frequency/Period/Amplitude/High-Level/Offset/Low-Level/Symmetry value.	1uHz~300KHz	4mV~6V	± 3.0V
pulse	Frequency/Period/Amplitude/High-Level/Offset/Low-Level/Width/ Width Fine value.	1uHz~10MHz	4mV~6V	± 3.0V
Noise	Stdev/ Mean value.			
DC	Offset value.			± 3.0V
Arb	Frequency//Period/Amplitude/High-Level/Offset/Low-Level value			

To set Arb waveform

Press the **Utility** → **Next Page4/4** → **AWG** → **Wave Type**, then select the Arb, and it has two types:

Stored Arb

Users can edit the Arb through the PC which has installed the EasyWave software. Send the edited Arb to the instrument through remote interface, and the Arb will be stored in the instrument. Or read from the U disk which has stored the Arb. Choose **Wave Type** → **Arb** → **Arb Type** → **Stored**, enter the Stored Arb interface and invoke the waveform in the internal storage and external storage device.

Built-in Arb

Choose **Wave Type** → **Arb** → **Arb Type** → **Built-in** to enter the following interface, Rotate the knob to move the cursor, press the knob to select to the desired waveform, and then return back to Built-in waveform interface.



Figure 117 Built-in Arb Interface

Setting



Figure 118 AWG Setting Interface

Output Load

Press **Utility** → **NextPage4/4** → **AWG** → **Setting** → **Output Load** to set High-Z or 50Ω.

Sync Output

Press **Utility** → **NextPage4/4** → **AWG** → **Setting** → **Sync Output**, the AWG provides Sync output through the [Aux In/Out] connector on the rear panel. When the Sync Output is on, the port can output a CMOS signal with the same frequency as basic waveforms (except the Noise and DC), arbitrary waveforms, and modulated waveforms (except external modulation).

OVP (Over Voltage Protection)

Press **Utility** → **NextPage4/4** → **AWG** → **Setting** → **OVP** to turn on or off the function. If the state is set to ON, overvoltage protection of AWG output port take effect once the condition is meeting (the absolute value of input voltage is higher than $4V \pm 0.5V$). When overvoltage protection occurs, a message will be displayed and the output is disabled.

Default

Press **Utility** → **NextPage4/4** → **AWG** → **Setting** → **Default** to recover the default values of AWG (Sine, 1.000 KHz, 4.000Vpp, 0.0mVdc, High-Z, Sync output off, OVP On).

Zero Adjust

Press **Utility** → **NextPage4/4** → **AWG** → **Setting** → **Zero Adjust**. The AWG can be calibrated by using **Auto** mode or **Manual** mode. The adoption standard of AWG calibrated is: when AWG outputs 0V DC signal, the corresponding channel at 1mv/div gear' mean value of oscilloscope is rang in $\pm 1mv$.

- **Auto mode:** This mode can only be performed with the channel1 of oscilloscope. Connect the output of AWG to the oscilloscope'channel1, press the Auto soft key, then the AWG starts to automatic calibrate, and displays " Zero Adjust Success!" .
- **Manual mode:** The AWG can be manually calibrated through any channel on the oscilloscope.

Take channel 2 as an example:

- a. Connect the output of AWG to the oscilloscope' channel 2, open the channel 2, and set DC coupling, open bandwidth limit, Probe is 1X.
- b. Adjust the voltage of channel 2 channel to 1mv/div, and make the waveform visible in the oscilloscope interface, press the **Measure** and measure the mean value of channel 2.
- c. Press the **Manual** and rotate the knob to adjust the waveform, so that the mean value of the observed CH2 will be in the range of $\pm 1mv$, and then press the **Save**, the oscilloscope displays "Zero Adjust Success!".

Systems

System Status

Press **Utility** → **NextPage4/4** → **AWG** → **System**, then select the System Status option to view the AWG's system information, including software version, hardware version,

and serial number. After finished, press the **return** softkey to exit the system information page.

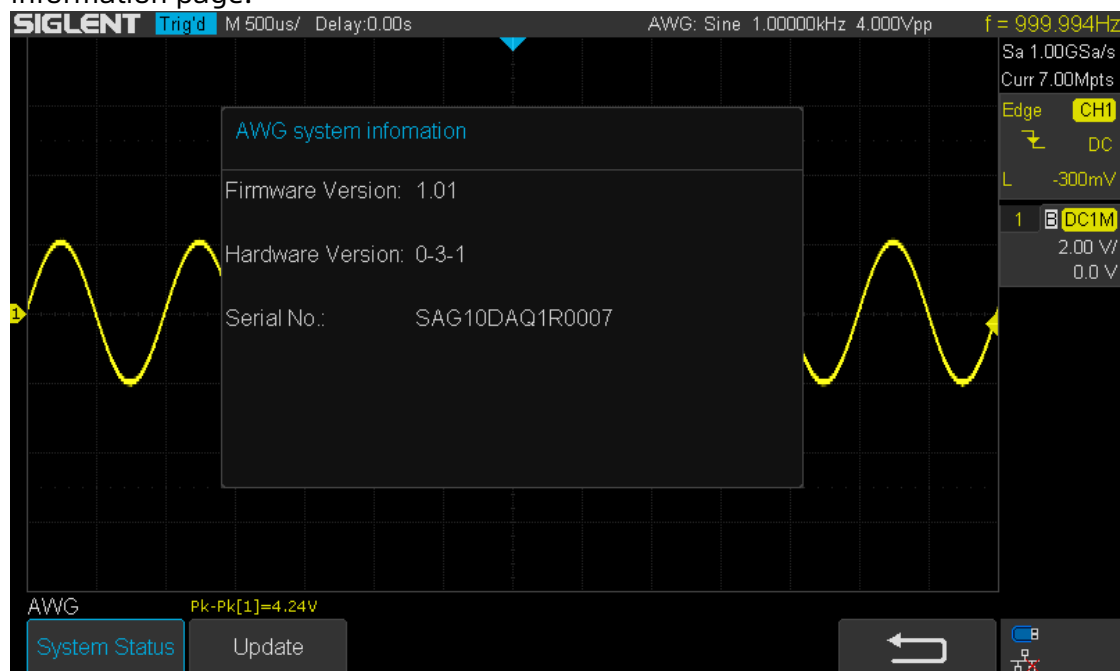

Figure 119 AWG System Information Interface

Update

The software version file of the AWG can be updated directly via U-disk. Follow the steps below:

1. Insert U-disk with firmware update file (*.ads) to USB host interface on the front panel of the oscilloscope. Then a message "USB Flash Drive detected!" will be displayed.
2. Press **Utility** → **NextPage4/4** → **AWG** → **System** → **Update**.
3. Expand the U disk directory, Select the firmware file (*.ads), then press the **Press to update**, an upgrade progress bar will be display on the interface.

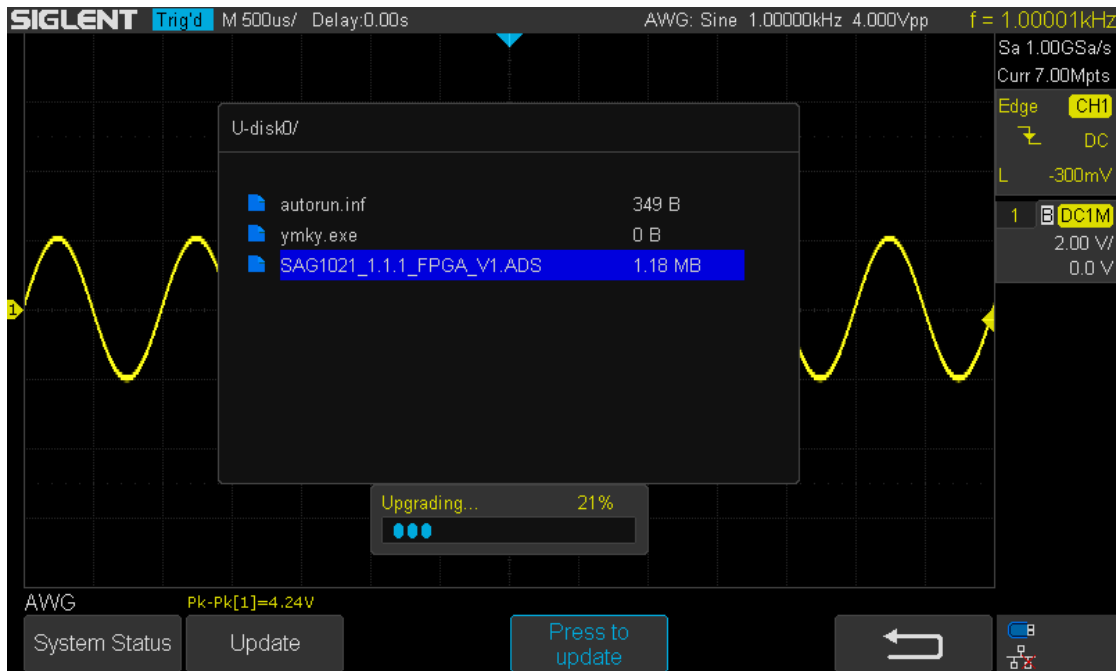

Figure 120 AWG Update Interface

4. After the updating is finished, the AWG will automatically disconnected and display a message "Update completed, please reconnect AWG device!"

Note: Don't cut off the power during the AWG is being updated!

Remove Device

Press **Utility** → **NextPage4/4** → **AWG** → **Remove Device**, and the oscilloscope interface display "AWG device removed!", the device can be pulled.

IO Set

The oscilloscope provides abundant IO interfaces, including: USB Device and LAN.

USB Device

Do the following steps to set the oscilloscope to communicate with PC via USB:

1. Install the USBTMC device driver on PC. Suggest you install NI Vista.
2. Connect the oscilloscope with PC using a standard USB cable
3. Press the **Utility** button on the front panel to enter the UTILITY function menu.
4. Press the **IO Set** softkey to enter the I/O SET function menu.
5. Press the **USB Device** softkey to view the USB ID.
6. Use EasyScopeX or NI Vista to communicate with the oscilloscope.

LAN

Do the following steps to set the oscilloscope to communicate with PC via LAN:

1. Connect the oscilloscope to your local area network using the network cable.
2. Press the **Utility** button on the front panel to enter the UTILITY function menu.
3. Press the **IO Set** softkey to enter the I/O SET function menu.
4. Press the **Net Interface** softkey; then; select **LAN**.
5. Press the **IP Set** softkey to enter the IP setting interface, see the picture below:
6. Press the DHCP softkey to turn on or turn off the DHCP.
 - **On:** the DHCP server in the current network will assign the network parameters (such as the IP address) for the oscilloscope.
 - **Off:** you can set the IP address, subnet mask, gate way manually.
 - Turn the **Universal Knob** to select the desired value.
 - Push the **Universal Knob** to change item horizontally.
 - Press the **Save** softkey to save the current setting.
7. Use EasyScopeX or NI Vista to communicate with the oscilloscope.

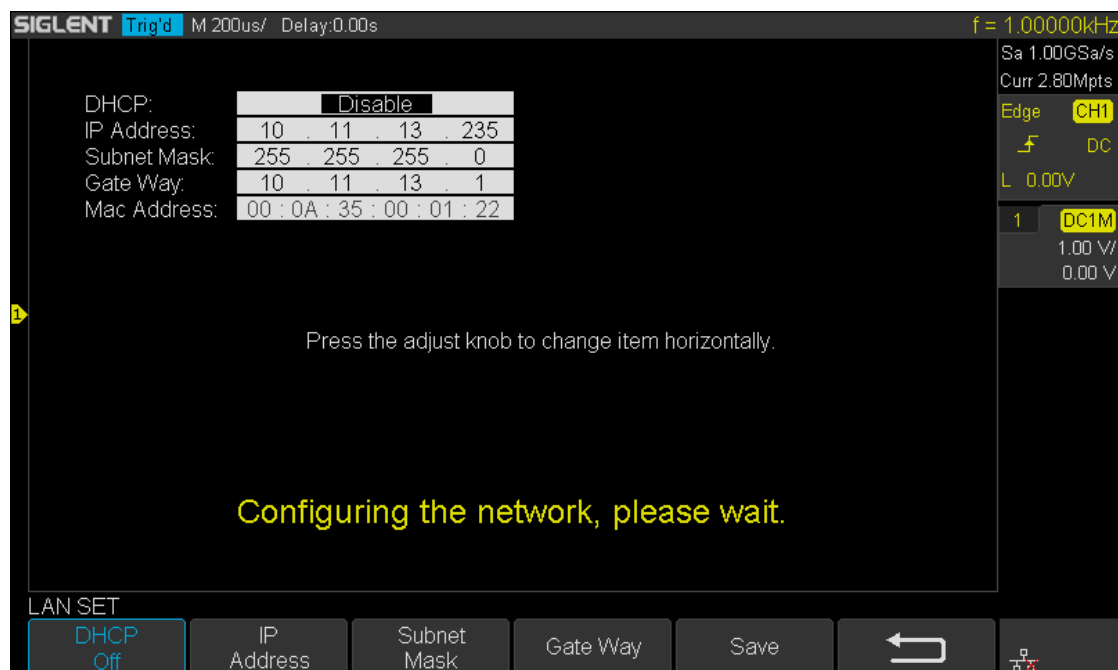

Figure 121 LAN Setting Interface

WLAN(Optional)

SDS1000X-E (4-channel) supports this function. Do the following steps to set the oscilloscope to communicate with PC via WLAN:

1. Connect the oscilloscope USB Host to your wireless network adapter, and make sure your local wireless network is normal.
2. Press the **Utility** button on the front panel to enter the UTILITY function menu.
3. Press the **IO Set** softkey to enter the I/O SET function menu.
4. Press the **Net Interface** softkey; then; select **WLAN**.
5. Press the **WiFi Set** softkey to enter the Wi-Fi set interface.
6. Press the Wi-Fi Operation softkey to turn on or turn off the WIFI set menu.
 - Off:** the WIFI set menu off
 - On:** you can set the SSID and PSK manually.
 - **Manual Scan:** press this softkey, the oscilloscope will search the network automatically. Turn the **Universal Knob** to select a network; then; press **Universal Knob** to confirm.
 - **SSID:** press this softkey, a dialogue box will pop up, enter your SSID then press **Confirm**.
 - **PSK:** press this softkey, a dialogue box will pop up, enter your SSID then press **Confirm**.
 - **Connect:** press this softkey to connect the wireless network.
7. Press **Connect** softkey when your SSID and PSK configuration finished.

8. Return to the I/O SET menu. Press the **IP Set** softkey to finish the IP configuration(see "To Set the LAN")
9. Use EasyScopeX or NI Vista to communicate with the oscilloscope.

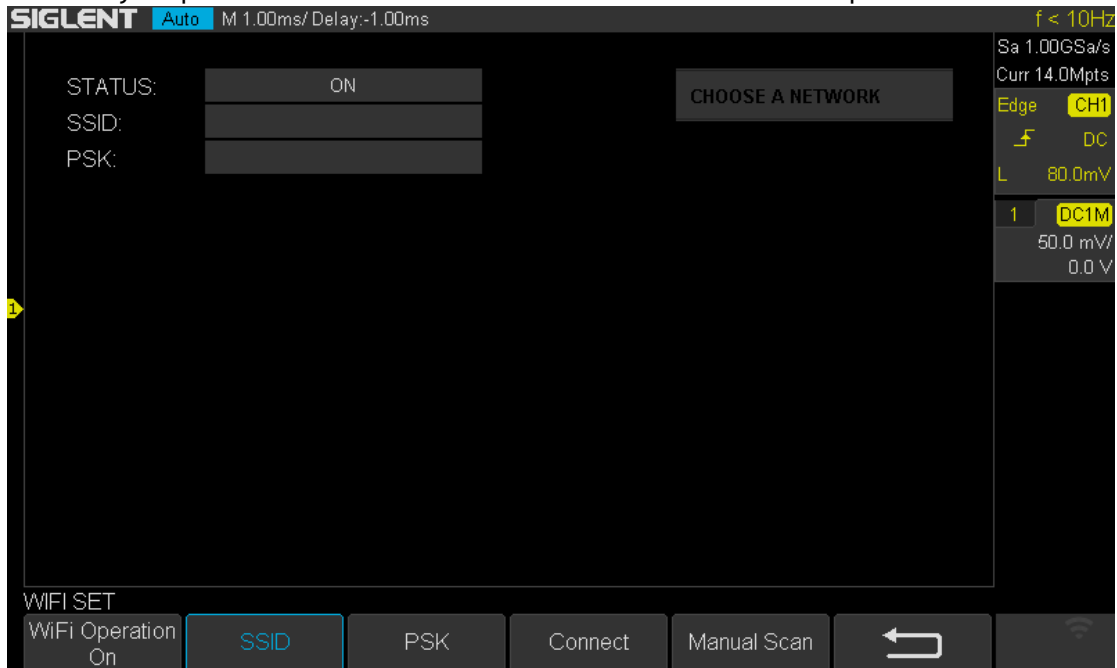

Figure 122 WIFI Setting Menu

Web Server

SDS1000X-E (4-channel) provide the web server function; you can access and control the oscilloscope using a web browser. Connect the oscilloscope to your LAN (or WLAN), then type the oscilloscope's IP address in the web browser. The oscilloscope's web interface is displayed.

Set Password

1. Press the **Utility** button on the front panel to enter the UTILITY function menu.
2. Press the **WebServer** softkey on the fourth page of utility function menu to enter the WEBSERVER menu.



Figure 123 Web Server Interface

- **Password:** press this softkey to set a new password,
- **Reset:** press this softkey to reset the password.
- **Save:** After setting a new password, press this softkey to make the password effective.

Web Browser

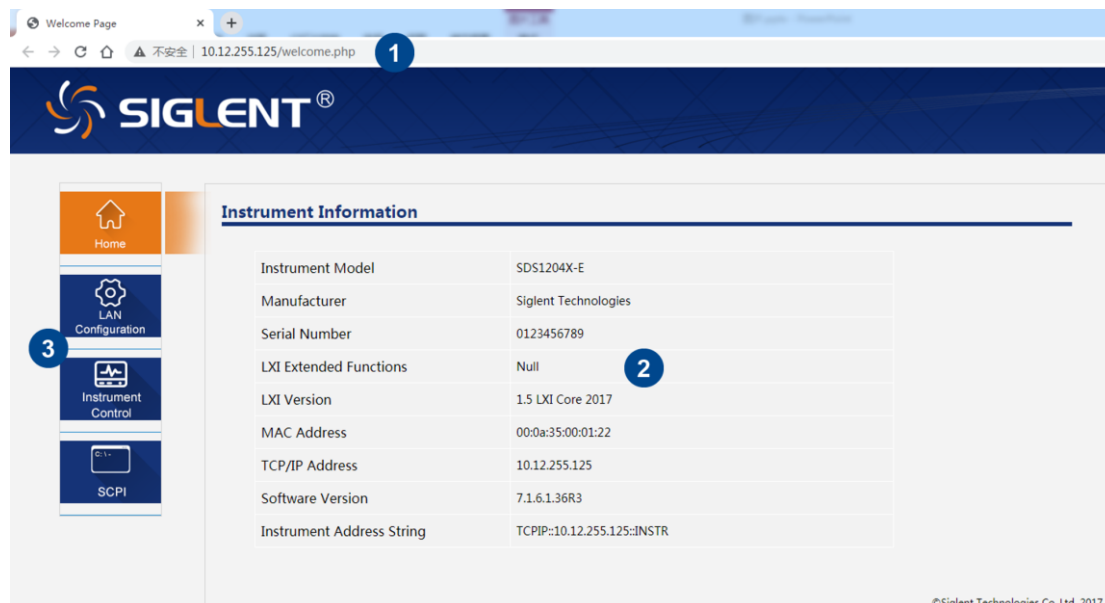

- 1 Input the IP address of the instrument
- 2 Information of the instrument
- 3 Click here to enter the instrument control interface.

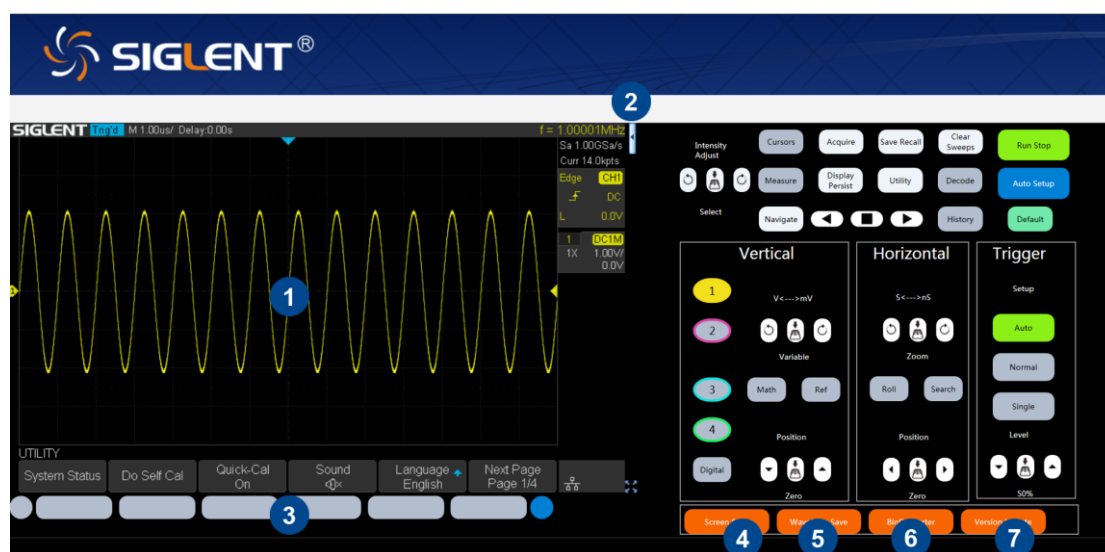

- 1 Display area of the instrument. The display in this area is a copy from the instrument display.
- 2 Click here to show the instrument control area.
- 3 Control area of the instrument. Using the mouse to operate in the area is equivalent to directly operating the instrument through the buttons
- 4 Click here to perform a screen shot
- 5 Click here to save the waveform data as a bin file and download it to the local computer
- 6 Click here to download the mini tool for converting bin file to csv file

7 [Click here to perform a firmware upgrade](#)

Counter

SDS1000X-E (4-channel) supports counter function, which is used to measure the frequency and period of a signal or count the events happening within it. The counter is asynchronous to the acquisition system of the oscilloscope. It can work well even if the acquisition of the oscilloscope is stopped (indicated by a red colored Run/Stop button)

- 1 Press **Utility** → **NextPage2/4** → **Counter** → **On** to turn on Counter function menu.
- 2 Press the **Mode** softkey to select **Frequency**, **Period** and **Totalizer**.
- 3 Press the **Source** softkey to select the source of the counter. The analog channel can be used as the source.
- 4 Press the **Statistics** softkey to turn on or off statistics.
- 5 Press the **Reset Statistics** softkey to clear and restart the statistics.
- 6 Press **Next Page1/2** → **Level**, turn the **Universal Knob** to set the level of the counter.

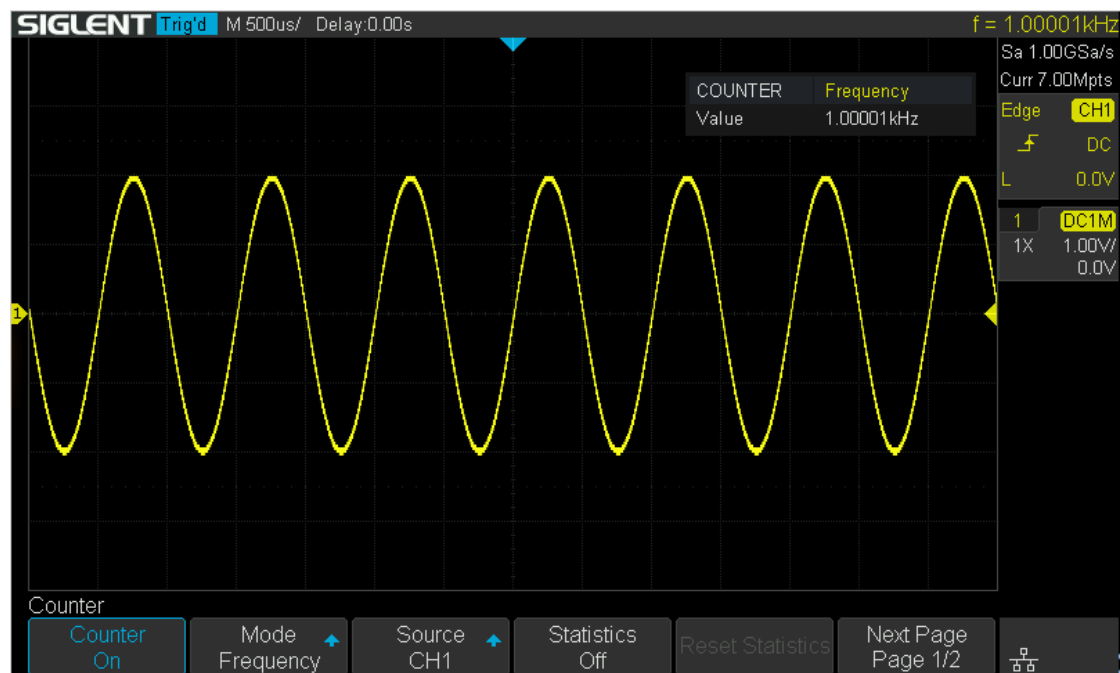

Figure 124 Counter Setting Interface

When the mode is selected as totalizer, the edge of the counting source needs to be set. When the counting gate is turned on, the counter can count only when the gate source meets the specified conditions.

- 1 Press **Gate Setting** → **On** to enter the Counter-Gate function menu.

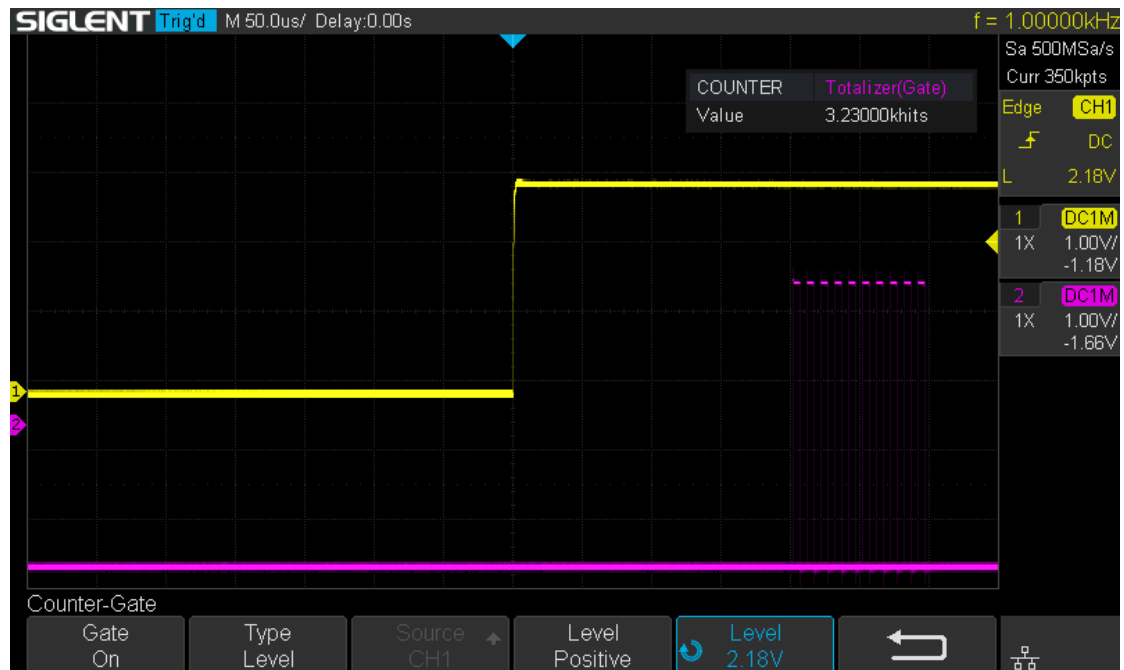

Figure 125 Counter-Gate Setting Interface

- 2 Press the **Type** softkey to select the gate type, **Level** or **After Edge**.
- 3 Gate source display area. C1 and C2 are gate sources of each other, C3 and C4 are gate sources of each other.
- 4 When the gate type is level, set the polarity (**Positive** or **Negative**) of the gate source. When the gate type is edge, set the slope (**Rising** or **Falling edge**) of the gate source.
- 5 Press the **Level** softkey and turn the **Universal Knob** to set the gate level.

When statistics are enabled, the counter will increment the data and display the statistics results on the screen.

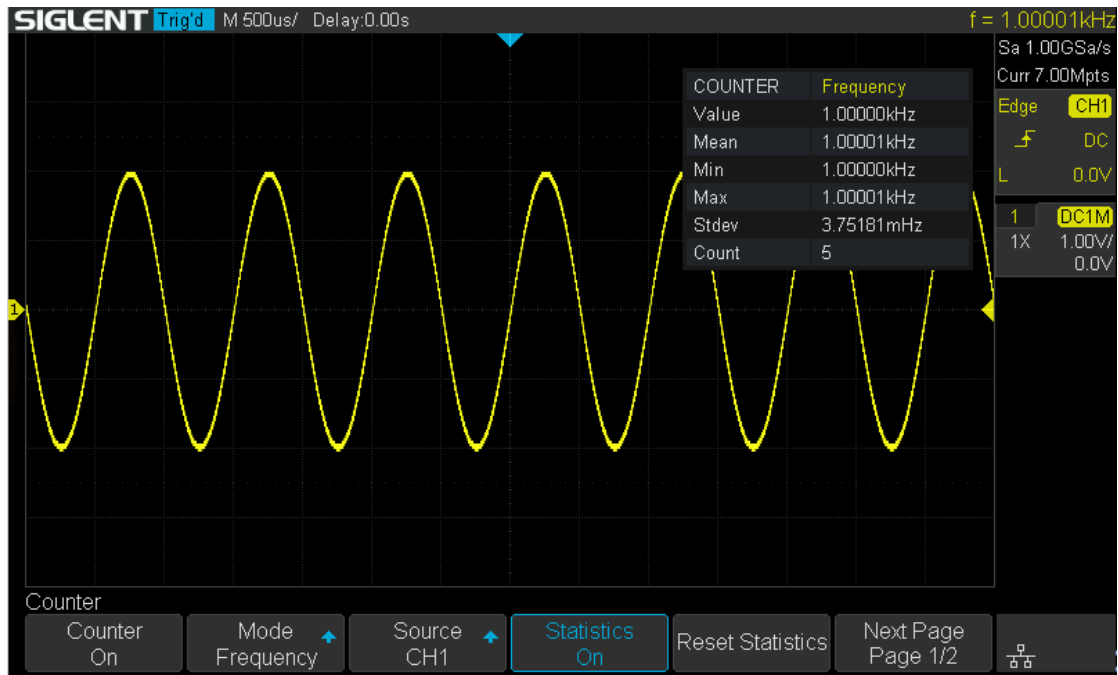

Figure 126 Statistics Function

- **Value:** The latest count
- **Mean:** The average of all historical counts
- **Min:** The minimum of all historical counts
- **Max:** The maximum of all historical counts
- **Stdev:** The standard deviation of all historical counts, used to judge the distribution of historical count parameters
- **Count:** Number of counts obtained

Press the **Clear Sweeps** button or **Reset Statistics** softkey to clear and restart statistics.

Data Logger

SDS1000X-E (4-channel) supports Sample logger and Measure logger, which can record waveform data and measurement value.

Press **Utility** → **NextPage2/4** → **Data Logger** to enter the DATA LOGGER function menu.



Figure 127 Data Logger Interface

Sample Logger

The Sample logger can record the original points of waveform in real time at equal intervals to realize the long-time observation of low-speed signals. The recorded data can be stored in the internal or external storage device in real time. After stopping recording, users can replay the waveform on the oscilloscope, also can export the recorded data and then analyze on the PC.

Press the **Sample Logger** softkey to enter the sample logger interface. At this time, all the buttons on the front panel will not respond (except for the menu softkey, **Print** and **Universal Knob**). Press the **Exit** softkey to exit the sample logger.

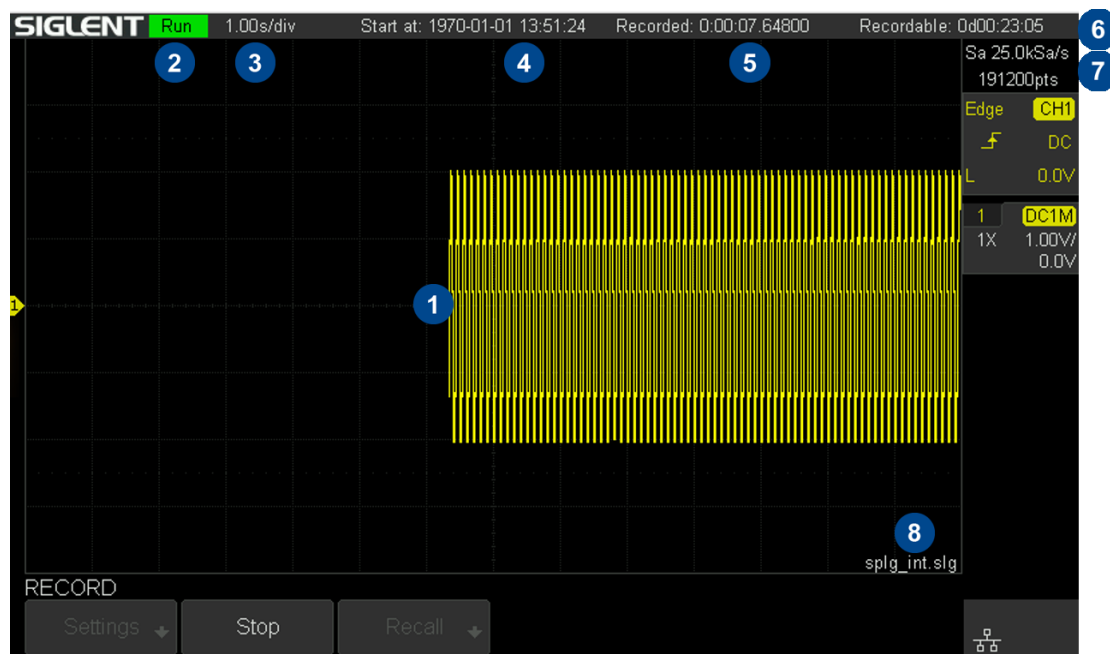

Figure 128 Sample Logger Interface

No.	Description
1	Recorded waveform
2	Record status (Run/Stop)
3	Horizontal scale
4	Start time
5	Recorded time
6	Remaining recordable time
7	Sample rate and recorded points of waveform
8	Storage location

Record Waveform

- 1 Press the **Record** softkey to enter the RECORD function menu.
- 2 Press the **Setting** softkey to enter the SETTINGS function menu. Press the **Rate** softkey to set the sampling rate of the waveform. Press the **Record to** softkey to set the storage location of the recorded data:
 - **Internal:** Record the data to internal, the last recorded internal data will be overwritten. Please confirm the operation when start to record.
 - **External:** Record the data to external storage device, and set the external storage path.



Figure 129 Settings Interface

- 3 Press the **Return** softkey to return to the RECORD function menu.
- 4 Press the **Start** softkey to start to record, and the record status in the top information bar is displayed as "Run".

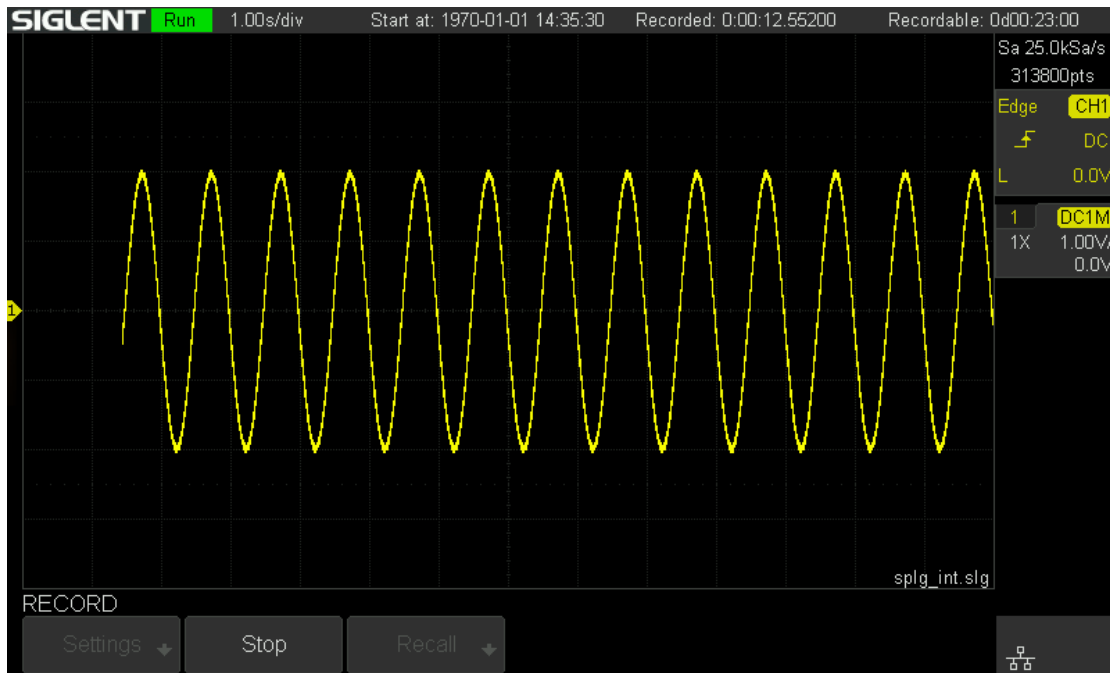

Figure 130 Start Recording Waveform

- 5 Press the **Stop** softkey to stop recording, and the record status in the top information bar is displayed as "Stop", the data is automatically stored in the storage location.
- 6 Press the **Recall** softkey to look back and analyze the waveform.

Note: When recording to external, the waveform data will be stored to the external in real time. Please do not pull out the U disk during the recording process!

Recall Recorded Waveform

- 1 Press the **Recall** softkey to enter the RECALL function menu.
- 2 Press the **Recall from** softkey to select the storage path.
- 3 Press the **Press to Recall** softkey to recall the recorded waveform data and

enter the CONTROL menu automatically.

Display Control

- 1 Press the **Horizontal Ref** softkey to set the horizontal reference position.
- 2 Rotate the **Horizontal Scale knob** to zoom the waveform with the horizontal reference as the center. Rotate the **Horizontal Position knob** to move the waveform.
- 3 Press the **View all** softkey to return to the initial configuration to view all waveforms.
- 4 After recalling the waveform, press the **Cursors** button to turn on the cursor function, which can measure and analyze the waveform on the screen. Please refer to the chapter "**Cursors**" for operation.

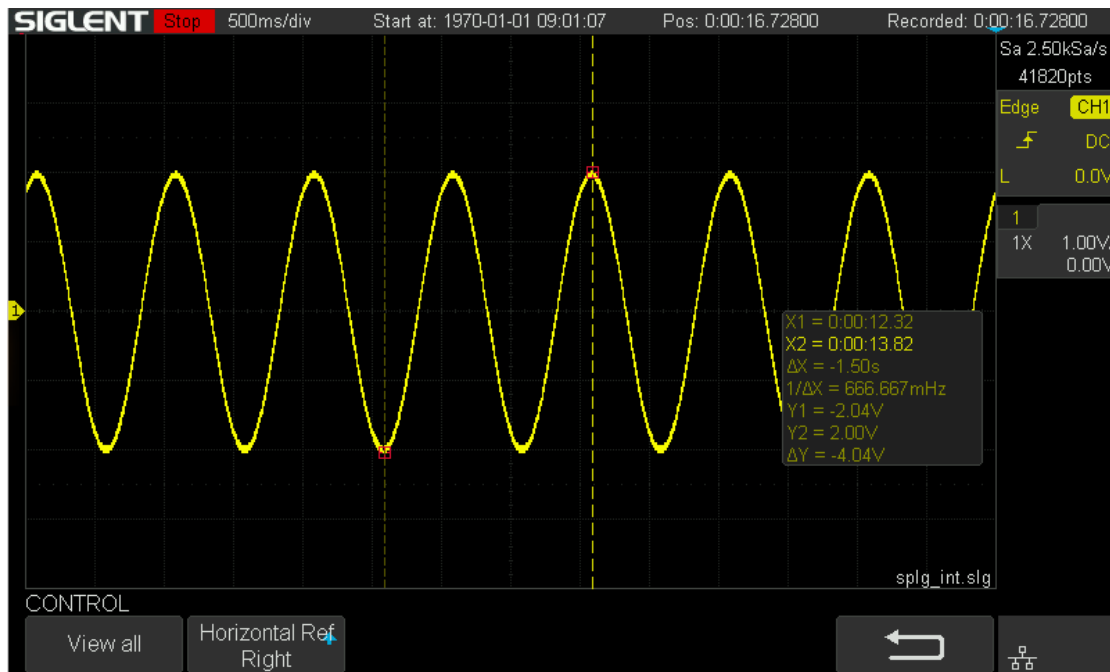

Figure 131 View Recorded Waveform

Manage Internal Record

- 1 Press the **Manage** softkey to enter the MANAGE function menu.
- 2 Press the **Export Internal Data** softkey to export the internal record to the external storage device. See the chapter "**Save and Recall**" for operation. The file format (*.slg) is described in detail in the document "How to Extract Data from the Binary File.docx". Please download from SIGLENT website. The oscilloscope provides a tool named fileconverter to convert the waveform file (*.slg) to CSV format. You can download it from the Save/Recall menu or the

- webserver.
- 3 Press the **Delete Internal Data** softkey to delete the internal record.

Measure Logger

The Measure logger can record the measured value of waveform in real time to realize the long-time measurement trend observation of low-speed signal. The measurement data is recorded in the internal, and can be stored to the internal or external storage device after stopping recording. It can support up to 4 traces of data at the same time.

Turn on the measure function and add measurement items, then press **Utility** → **NextPage2/4** → **Data Logger** → **Measured Logger** to turn on the measure logger; Press the **Exit** softkey to exit the measure logger.

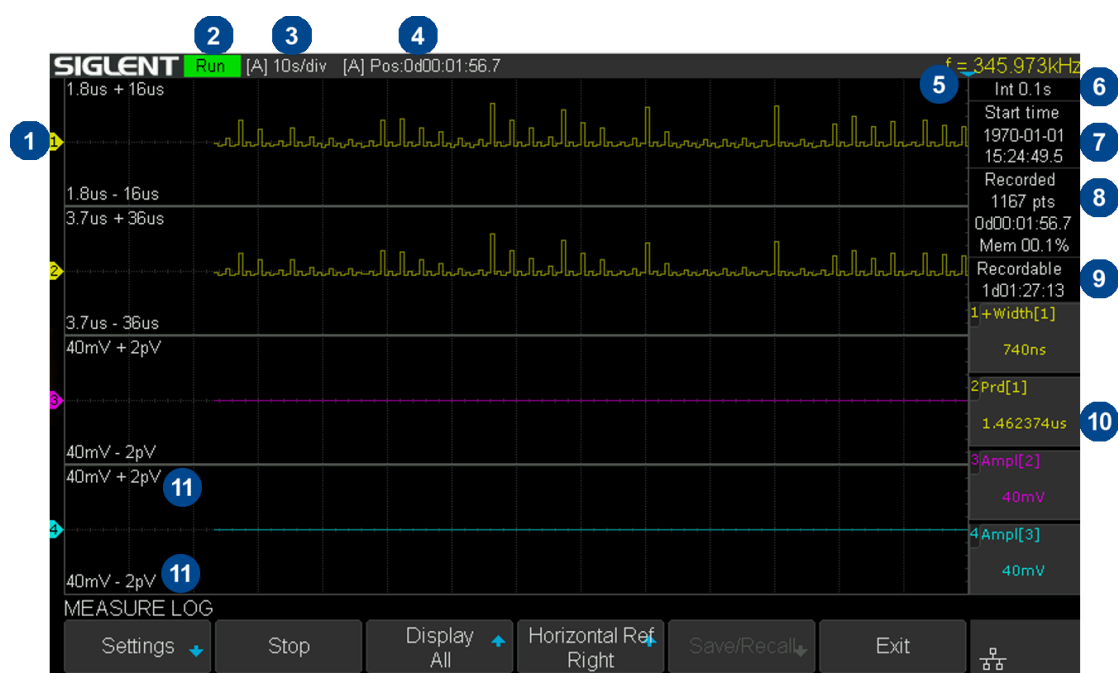

Figure 132 Measure Logger Interface

No.	Description
1	Record trace
2	Record status (Run/Stop)
3	[Auto/Manual] Horizontal scale
4	[Auto/Manual] Time value of the first point (centered on horizontal reference position)
5	Horizontal reference position
6	Recording interval
7	Start time
8	Number of recorded points, Recorded time, Used memory
9	Remaining recordable time

10	The current value of measurement items
11	Upper and lower scale of measurement items

Start/Stop Recording

- 1 Press the **Setting** softkey to enter the SETTINGS function menu. Set record interval, record trace and the corresponding measurement item.



Figure 133 Settings Interface

- 2 After setting, press the **Return** softkey to return to the previous menu.
- 3 Press the **Start** softkey to start to record, the record status in the top information bar is displayed as "Run". During the recording process, the measure logger automatically adjusts the horizontal scale to show the trace. Users also can turn the **horizontal scale/position knob** to enter the manual mode to zoom and move the recording trace.

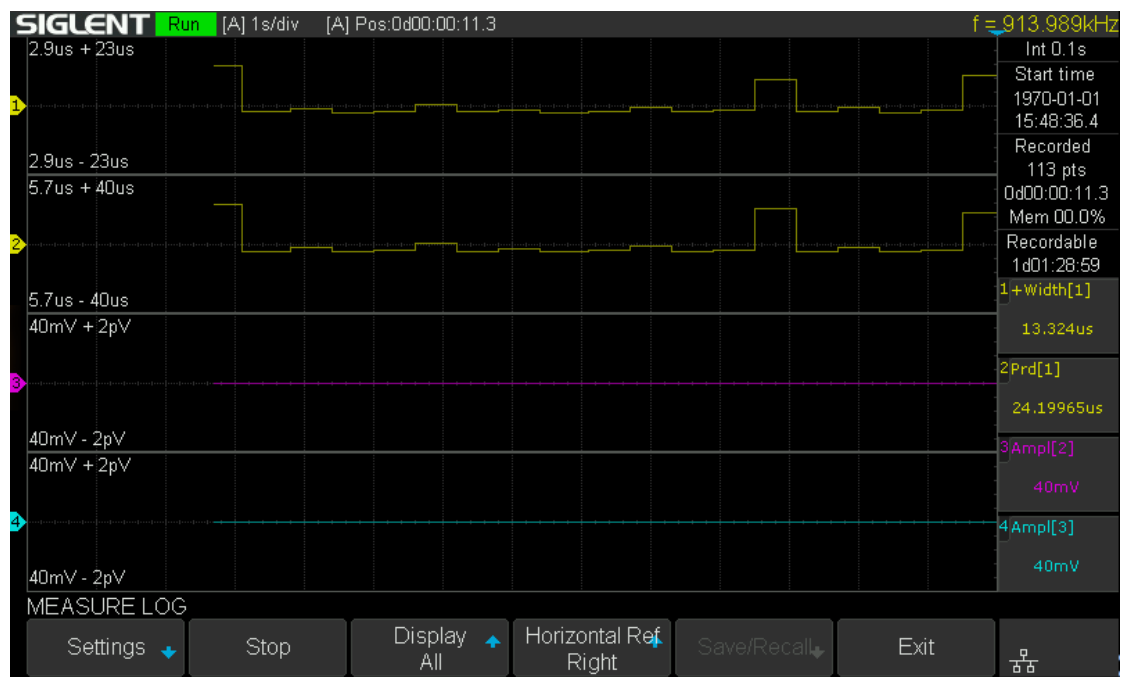

Figure 134 Start to Record Measurement Data

- 4 Press the **Stop** softkey to stop recording, the record status in the top information bar is displayed as "Stop".

Display Control

- 1 Press the **Display** softkey to select **All**, all traces are displayed in the waveform area. When a trace is selected, only the selected trace is displayed in the waveform area. Press the channel button corresponding to the trace to switch all/individual display.



All Traces Display

Single Trace Display

- 2 Press the **Horizontal Ref** softkey to set the horizontal reference position.
- 3 Press the **Cursors** button to turn on the cursors function. Move the cursor to obtain the measured value of each point.
 - a. Press the **Select** softkey to select the cursor **T1**, **T2** or **T1-T2**.
 - b. Press the **Strategy** softkey to choose the behavior of cursors when horizontal scale or position is changed.
 - **Fixed Position:** cursors remain fixed to the grid position on the display
 - **Fixed Time:** the value of cursors remain fixed.
 - c. Press the **Track Mode** softkey to select the track mode of T-Cursors.
 - **Normal:** Track the data at the time of T-Cursors
 - **Maximum:** Track the maximum value of the data within a pixel where T-Cursors are located.
 - **Average:** Track the average value of the data within a pixel where T-Cursors are located.
 - **Minimum:** Track the minimum value of the data within a pixel where T-Cursors are located.
 - **Peak:** Track the data with the maximum deviation from the overall average value in a pixel where T-Cursors are located. When two cursors are at the same position, T1 will track the maximum value and T2 will track the minimum value.

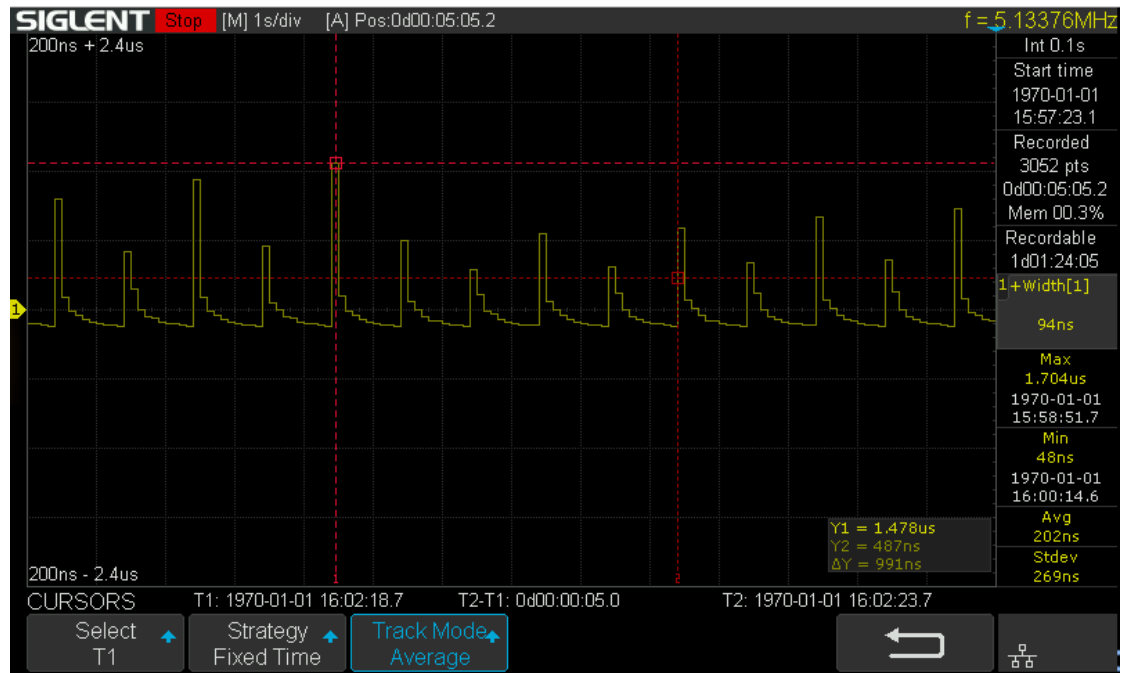

Figure 135 Cursors of Measure Logger

Storage Measurement Record

- 1 Press the **Save/Recall** softkey to enter the SAVE/RECALL function menu.

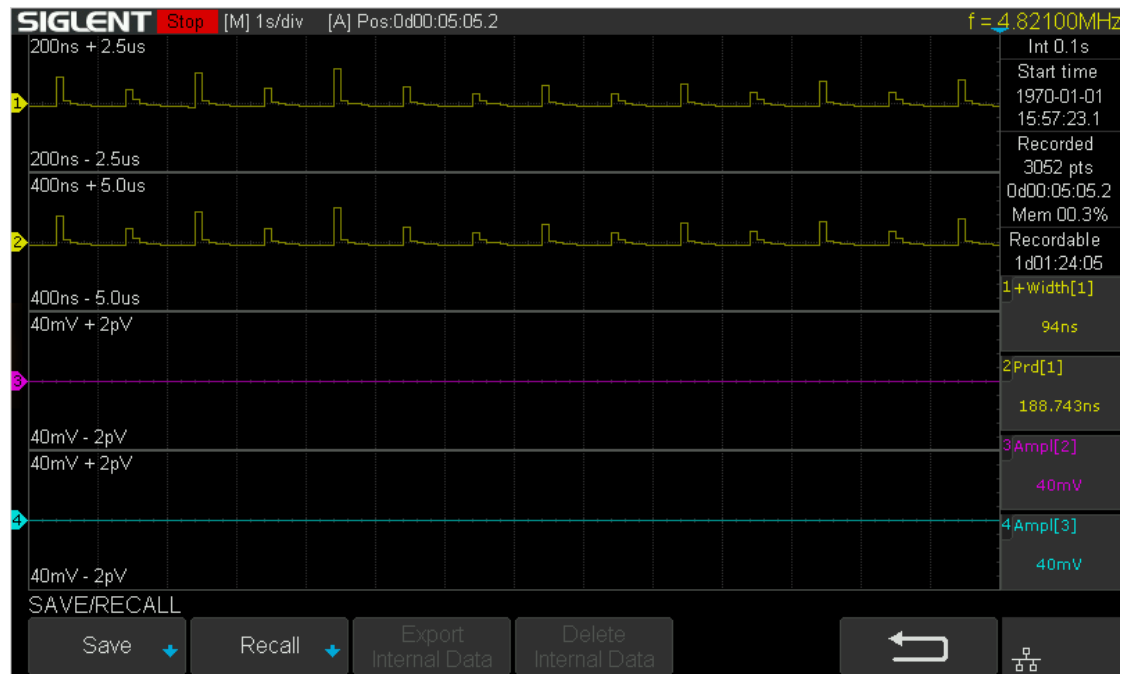

Figure 136 Save/Recall of Measure Logger

- 2 Press the **Save** softkey to enter the SAVE menu.



Figure 137 Save of Measure Logger

- 3 Press the **Save to** softkey to select where to store.
 - **Internal:** The measurement data will be saved in binary data format, and the last data stored internally will be overwritten.
 - **External:** The measurement data can be saved as binary data (*.mlg), CSV data or MATLAB data
- 4 Press the **Press to save** softkey to save.

Recall Measurement Record

- 1 Press **Save/Recall** → **Recall** to enter the RECALL function menu.
- 2 Press the **Recall from** softkey to select where to recall. Only binary files can be recalled from internal; while binary files or MATLAB files can be recalled from external. If the current data is not saved, it will be covered by the recalled the data.
- 3 Press the **Press to Recall** softkey to recall.

Manage Internal Record

Export or delete the internal record, it is similar to "**Manage Internal Record**" of Sample Logger.

Update Firmware and Configuration

The firmware and configuration can be updated directly via USB flash driver.

Do the following steps to update the firmware:

1. Insert the USB flash driver which with the firmware and the configure files inside into the USB host interface on the front panel of the oscilloscope.
2. Press the **Utility** button on the front panel to enter the UTILITY function menu.
3. Press the **Next Page** softkey to go to the third page of the UTILITY function menu.
4. Press the **Update** softkey to enter the UPDATE function menu.
5. Press the **Firmware** softkey to open the file manager.
6. Turn the **Universal Knob** to select the update file which should be with an ADS postfix; and then press the **Press to Update** softkey to start update the firmware. The process needs about 7 minutes. And during the update, do not remove power to the oscilloscope, otherwise the oscilloscope may be permanently damaged and may not restart again.
7. After finish the update, the screen will pop-out the message **“Firmware decompressed. Please restart and wait...”** .
8. Restart the oscilloscope to finish the firmware update.

Do the following steps to update the configuration:

1. Insert the USB flash driver which with the firmware and the configure files inside into the USB host interface on the front panel of the oscilloscope.
2. Press the **Utility** button on the front panel to enter the UTILITY function menu.
3. Press the **Next Page** softkey to go to the third page of the UTILITY function menu.
4. Press the **Update** softkey to enter the UPDATE function menu.
5. Press the **Configure** softkey to open the file manager.
6. Turn the **Universal Knob** to select the update file (*.CFG file extension) and then press the **Press to Update** softkey to start update the firmware. The process needs about 30 seconds.
7. After finish the update, the screen will pop-out the message **“Firmware decompressed. Please restart and wait...”**
8. Restart the oscilloscope to finish the configuration update.

Do Self-Test

Self-tests include screen test, keyboard test, and LED test. Self-tests used to test the screen, buttons, knobs and LED lights whether works well.

Screen Test

1. Press the **Utility** button on the front panel to enter the UTILITY function menu.
2. Press the **Next Page** softkey to go to the third page of the UTILITY function menu.
3. Press the **Do Self Test** softkey to enter the SELFTEST function menu.
4. Press the **Screen Test** softkey to enter the screen test interface, as the picture shown below, the screen display pure red.

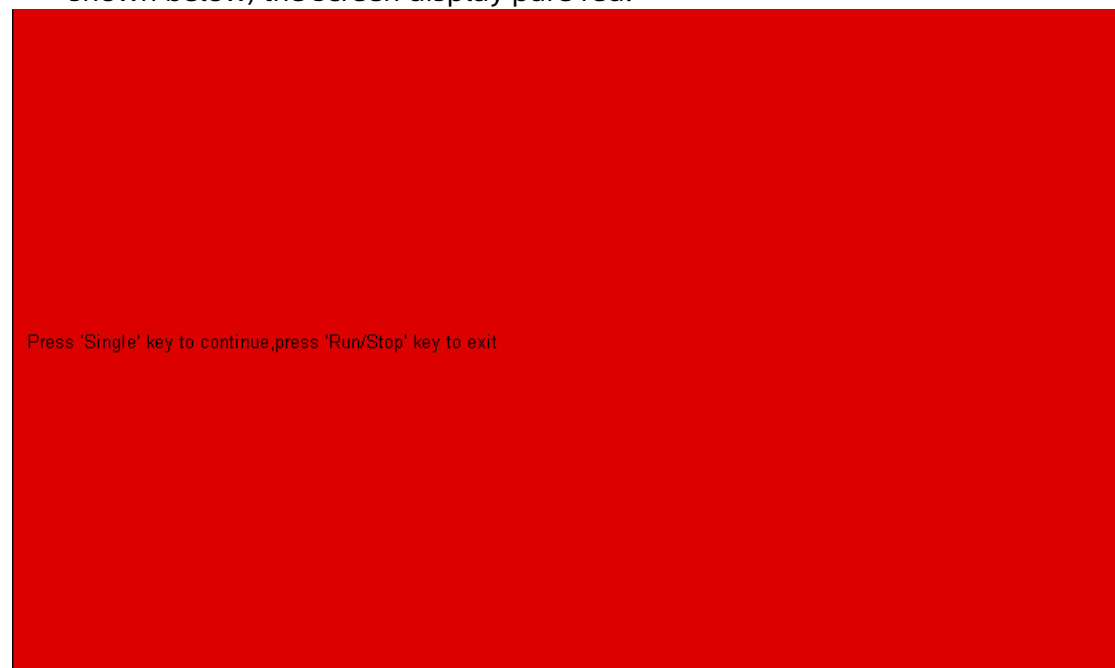

Figure 138 Screen Test

5. Press the **Single** button on the front panel continually as it says in the picture above. The screen displays green, blue and red again. It is easy to check chromatic aberration, stain and scratch of the screen under the condition.
6. Press the **Run/Stop** button on the front panel to exit the screen test program.

Keyboard Test

Keyboard test is used to test that if the keys or the knobs work well.

Do the following steps to do keyboard test:

1. Press the **Utility** button on the front panel to enter the UTILITY function menu.
2. Press the **Next Page** softkey to go to the third page of the UTILITY function menu.
3. Press the **Do Self Test** softkey to enter the SELFTEST function menu.
4. Press the **Keyboard Test** softkey to enter the keyboard test interface, as the picture shown below.

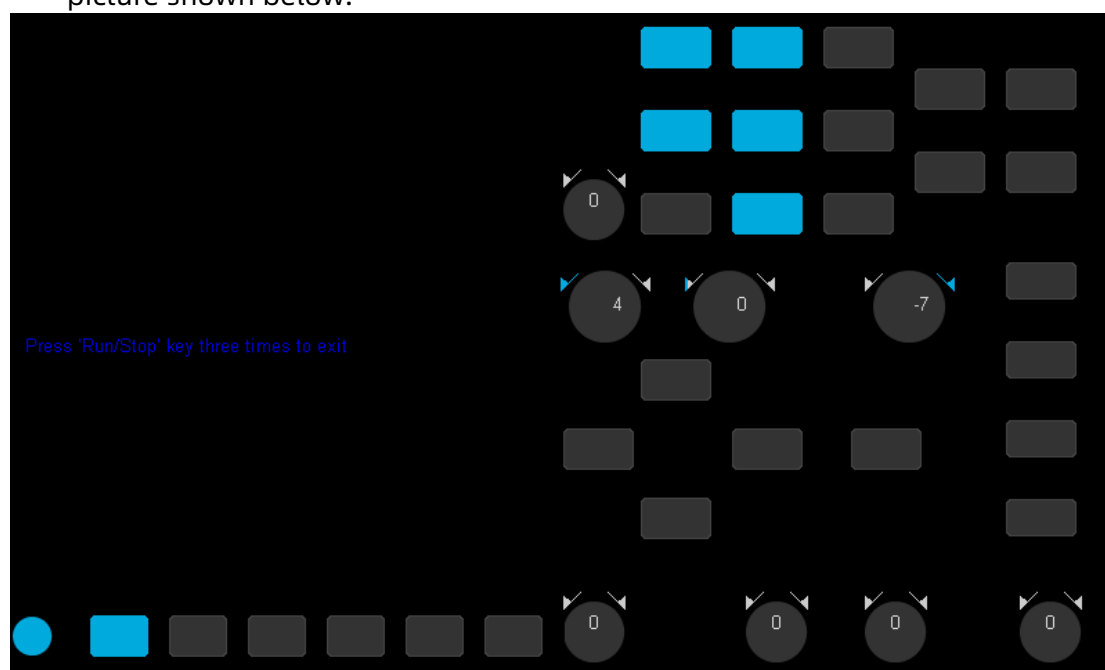

Figure 139 Keyboard Test

5. To perform the knobs and the buttons test.
6. Knobs test: the default value is 0. Turn left to increase the value while turn right to decrease; push the knob to set the value to 0. Test every knob randomly.
7. Keys test: the first time to press the key to light it up, and a second press to die out. Test every button randomly.
8. Press the **Run/Stop** button 3 times to exit the keyboard test program.

LED Test

LED test is used to test that if the button lights work well.

1. Press the **Utility** button on the front panel to enter the UTILITY function menu.
2. Press the **Next Page** softkey to go to the third page of the UTILITY function

menu.

3. Press the **Do Self Test** softkey to enter the SELFTEST function menu.
4. Press the **LED Test** softkey to enter the keyboard test interface, as the picture shown below.

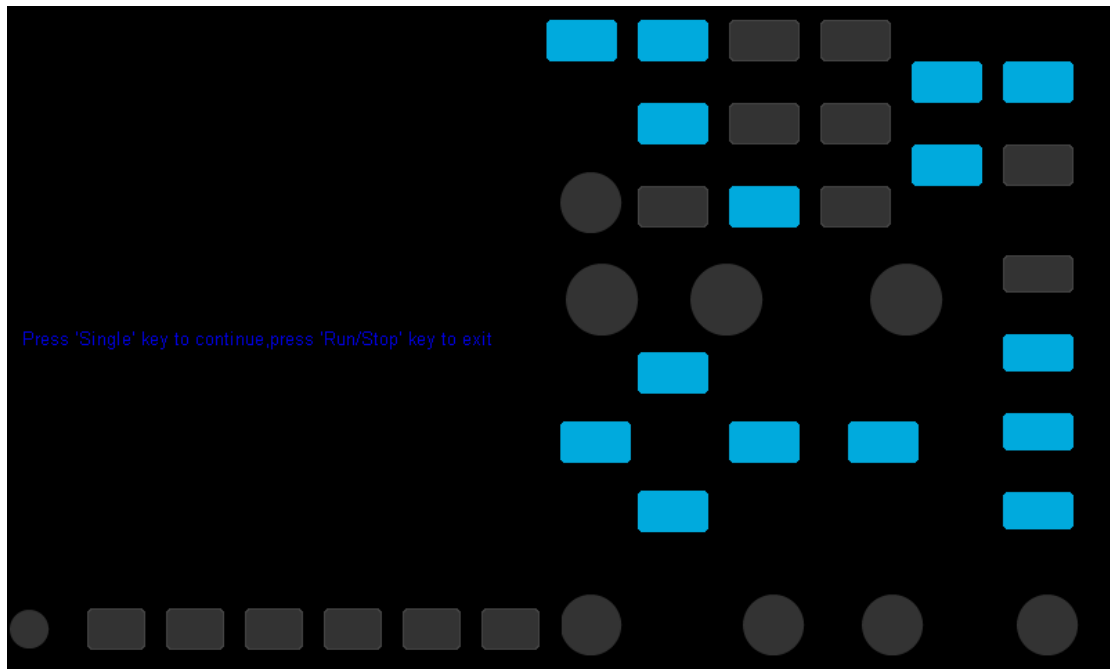

Figure 140 LED Test

5. According to the prompting information displaying on the screen, press the **Single** button continually to light the button lights one by one. The first time to press the **Single** button, the **Run/Stop** button displays red, and the second press the **Run/Stop** button displays green. Then the other button lights will be lighted one by one. At last all the lights will be lighted at the same time.
6. Press the **Run/Stop** button to exit the LED test program.

Screen Saver

When the oscilloscope enters the idle state and holds for a certain period of time, the screen saver program will be enabled.

Do the following steps to set the screen saver time:

1. Press the **Utility** button on the front panel to enter the UTILITY function menu.
2. Press the **Next Page** softkey to go to the third page of the UTILITY function menu.
3. Press the **Screen Saver** softkey; and then turn the **Universal Knob** to select the desired screen saver time. The screen saver time can be set to **1min**, **5min**, **10min**, **30min**, and **1hour**. Also you can select **Off** to turn off the screen saver function

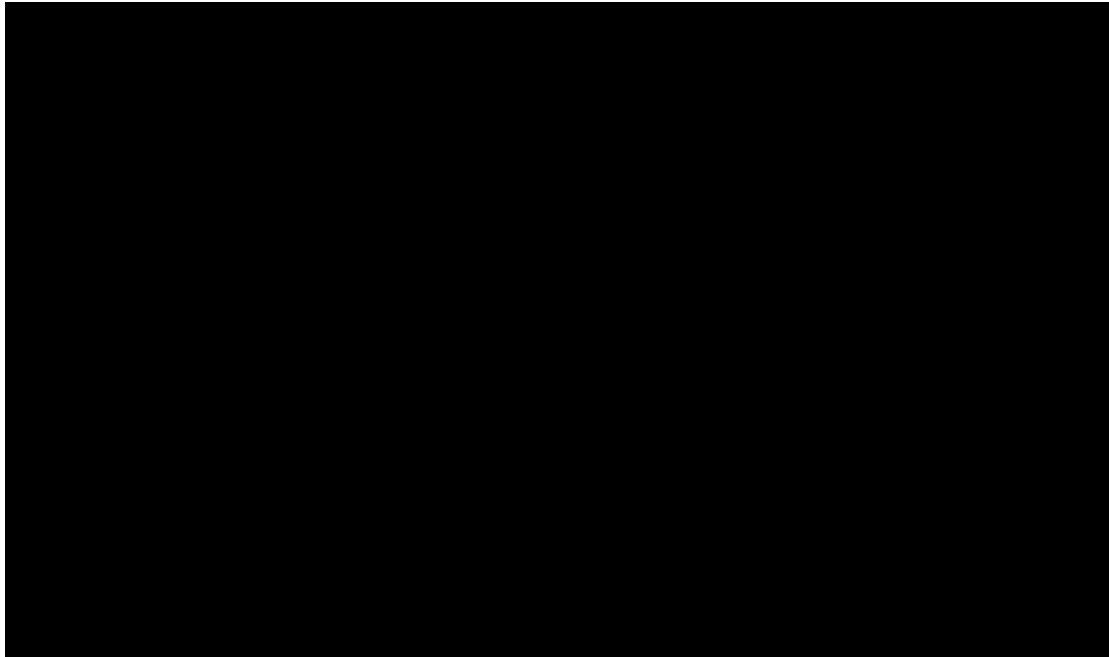

Figure 141 Screen Saver Interface

4. Press the any button on the front to exit the screen saver program.

Date/Time

SDS1000X-E (4-channel) supports setting date and time. After restarting the oscilloscope, you need to reset the system time.

- 1 Press **Utility** → **NextPage3/4** → **Date/Time** to enter the DATA/TIME function menu.
- 2 Press the **Display** softkey to select **On** to display the date and time.

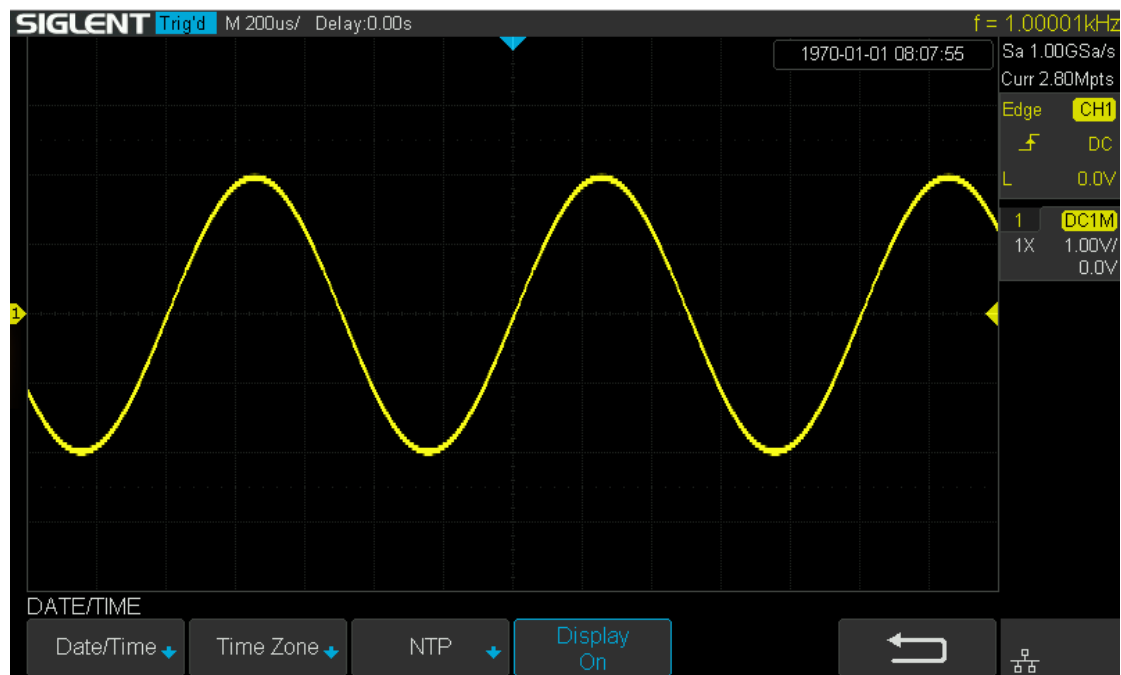

Figure 142 Date/Time Function Interface

Set Date/Time

Press the **Date/Time** softkey to enter the Data/Time setting menu. Press the **Date** softkey and press the **Universal Knob** to select year, month or day, then rotate the **Universal Knob** to change value. Modifying the time is similar to the date.



Figure 143 Setting Date/Time

Set Time Zone

- 1 Press the **Time Zone** softkey to enter the Time Zone function menu, and pop up time zone page.
- 2 Rotate the **Universal Knob** to select the time zone.
- 3 Press the **Confirm** softkey to confirm the selection.



Figure 144 Time Zone Setting Interface

Set NTP

- 1 Press the **NTP** softkey to enter the NTP function menu,
- 2 Press the **Server IP** softkey to set the server IP address according to the prompt and press the **Sync** softkey to synchronize the time.
- 3 Press the **Power On Sync** softkey to select **On** or **Off**. When set to **On**, the oscilloscope will automatically synchronize the time after the power on.
- 4 Press the **Periodic Sync** softkey to select **On**; press the **Interval** softkey and rotate **Universal Knob** to set the value.

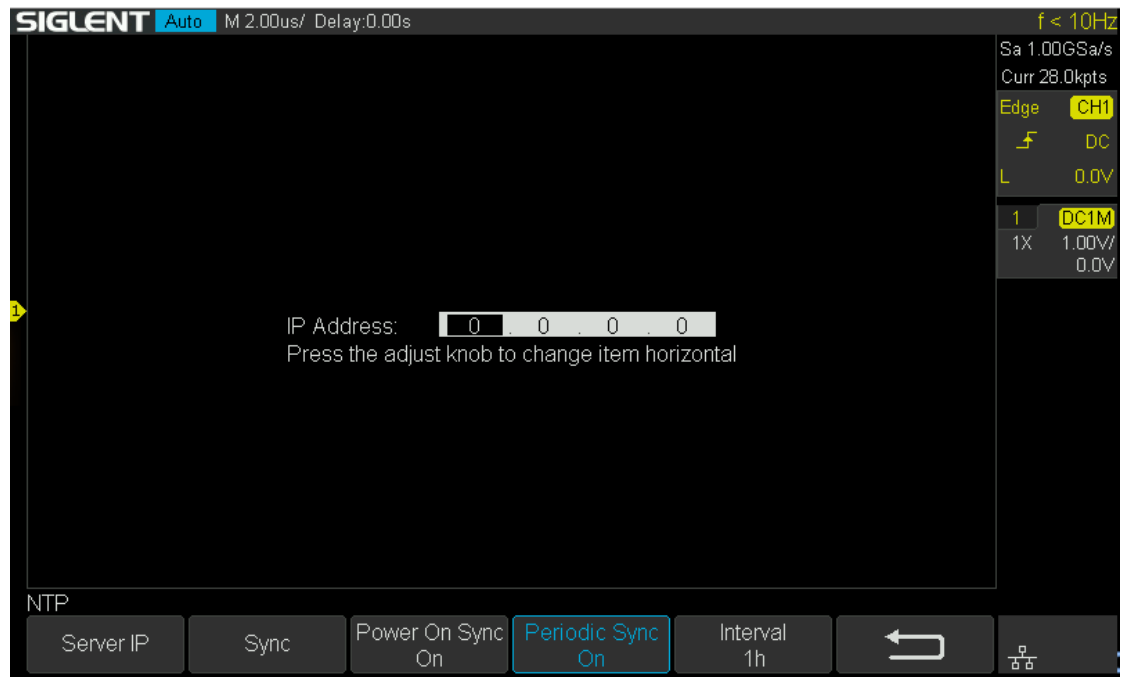

Figure 145 NTP Setting Interface

Reference Position

The reference position setting determines the physical point that the oscilloscope uses during vertical and horizontal scale changes. In some situations, it is more convenient to use a fixed position on the display.

Press the **Utility** button on the front panel and then press the **Reference Pos.** softkey to enter the Reference POS menu.

Press the **Vertical** softkey to select **Fixed Offset** or **Fixed Position**.

Fixed Position: when the vertical gain is changed, the oscilloscope will keep the vertical offset level indicator stationary.

Fixed offset: when the vertical gain is changed, the oscilloscope will have the vertical offset level indicator move with the actual voltage level.

Press the **Horizontal** softkey to select **Fixed Delay** or **Fixed Position**.

Fixed Position: when the timebase is changed, the oscilloscope will keep the horizontal offset indicator stationary.

Fixed Delay: when the timebase is changed, the oscilloscope will have the horizontal offset indicator move with the trigger point.

Power On Line

Press the **Utility** button on the front panel; then; press **Power On Line** softkey to select **Enable** or **Disable**.

- **Enable:** when the oscilloscope is energized, the oscilloscope will start automatically by itself.
- **Disable:** when the oscilloscope is energized; then; press the **power** key at the lower-left corner of the front panel to start the oscilloscope.

Option Management

The SDS1000X-E and SDS1000X-U provide multiple options to fulfill your measurement requirements. Please contact your **SIGLENT** sales representative or **SIGLENT** technical support to order the corresponding options. You can view the options currently installed on the oscilloscope or activate the newly purchased option license codes through this menu.

Do the following steps to install the option on the oscilloscope:

1. Press the **Utility** button on the front panel to enter the UTILITY function menu.
2. Press the **Next Page** softkey to go to the third page of the UTILITY function menu.
3. Press the **Options** softkey to enter the OPTION function menu.

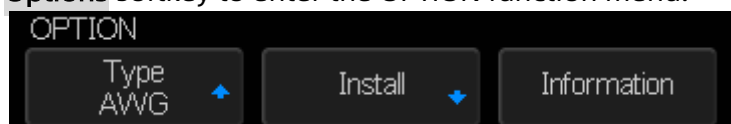

Figure 146 OPTION Function Menu

4. Press the **Type** softkey; then turn the **Universal Knob** to select the module to be installed and push down the knob to confirm.
5. Press the **Install** softkey to enter the LABEL function menu to input the license.

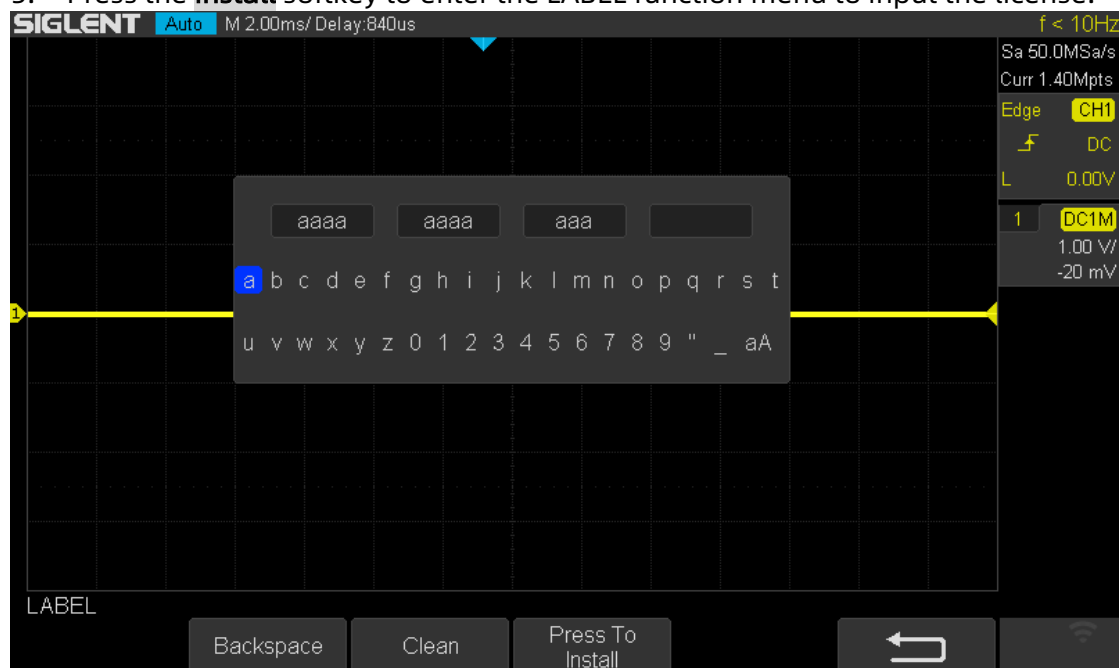

Figure 147 LABEL Function Menu

- Turn the **Universal Knob** to select character
- Push down the **Universal Knob** to confirm the characters
- Press the **Press To Install** when license key input done,

- Press the **Clean** softkey or the **Backspace** softkey to delete the incorrect character.
6. Press the **Information** softkey to view the option information.

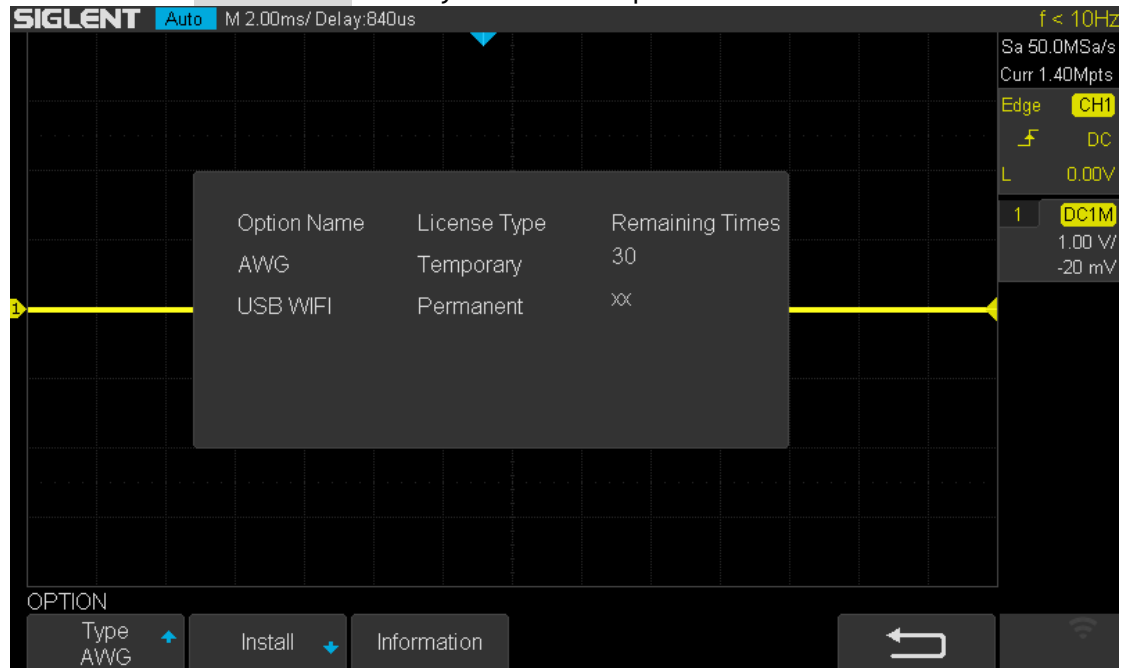

Figure 148 Option Information

Bode Plot II

The bode plot application for the SDS1000X-E (4-channel) control an external arbitrary waveform generator(only Siglent’s arbitrary waveform generator can be supported) to sweep a sine wave across a range of frequencies while measuring the input to and output from a device under test (DUT). At each frequency point, gain and phase are measured and displayed on the Bode plot.

Perform Bode Plot

The following steps briefly describe how to perform the Bode Plot:

1. Press the **Utility** button on the front panel to enter the UTILITY function menu, and then press **the Next Page** softkey to enter the second page.
2. Press **Bode Plot II** softkey to enter the BODE PLOT II menu. At this time, only the **Default** and **Auto Setup** button which on the front panel are available.



Figure 149 BODE PLOT II Menu

3. Configure the parameters (see the section “Setting” for details).
4. Press the **Run** softkey to perform the test.

Setting

1. Press the **Config** softkey to enter the CONFIGURE menu. All the parameters in this menu are used to configure the external AWG.



Figure 150 CONFIGURE Menu

- 1) Press the **Source** softkey to enter SOURCE menu.
 - Press the **Interface** softkey and turn the **Universal Knob** to select the connection mode of AWG.

USB	Connect the oscilloscope USB host to the external AWG's USB
-----	---

- type. It contains 6 types of Vpp, Vrms, dBV, dBu, dBm, Arbitrary dB. When the unit type is dB, it is necessary to set the reference level.
- Press the **Load** soft key to switch the load between 50Ω, 75Ω, 600Ω, Hi-Z. It also can turn the **Universal Knob** to set the load value.
- 5) Press the **Set Channel** softkey to enter the SET CHANNEL menu.
- Press the **DUT Input** softkey to select the corresponding input signal channel. Press the **DUT Output 1** soft key to select the corresponding output signal channel, and support up to 3 channels as the signal output.
 - Press the **Channel Gain** softkey continuously to select the gain type as "Hold" or "Auto" .
2. Press the **Display** soft key to enter the DISPLAY menu. The display menu displays the configuration related to bode plot interface.

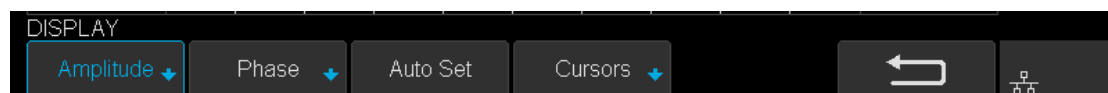

Figure 152 DISPLAY Menu

- 1) Press the **Amplitude** softkey to enter the AMPLITUDE menu.
- Press the **Scale** softkey and turn the **Universal Knob** to set the amplitude display scale.
 - Press the **Ref Level** softkey and turn the **Universal knob** to set the amplitude display reference level, or press the **Universal knob** directly to enter the value in the pop-up virtual keyboard.
 - Press the **Mode** softkey to set the display mode of the amplitude.
 - Vout/Vin: display the ratio of the DUT output to the DUT input. Press the **Axis Type** softkey to set the vertical axis to logarithmic or linear.
 - Vout: display the DUT output voltage value directly. Press the **unit** softkey to set the unit type to Vpp, Vrms, dBV, dBu, dBm, or Arbitrary dB.
 - Press the **Auto Set** softkey to automatically adjust the vertical direction parameters based on the Bode plot data.
- 2) Press the **Phase** softkey to enter the PHASE menu.
- Press the **Scale (Ref Level)** softkey and turn the **Universal Knob** to set the phase display scale (phase display reference level), or press the **Universal Knob** directly to enter the value in the pop-up virtual keyboard.
 - Press the **Unit** softkey continuously to switch the phase unit to Deg or Rad.
 - Press the **Auto Set** softkey to automatically adjust the vertical direction parameters based on the Bode plot data.
- 3) Press the **Auto Set** softkey to automatically adjust the vertical direction parameters based on the Bode plot data.

- 4) Press the **Cursors** soft key to enter the CURSORS menu. See the chapter "Cursor" for details.
3. Press the **Data** softkey to enter the DATA menu. The data menu displays the configurations of bode plot measurement results.



Figure 153 DATA Menu

- 1) Press the **List** softkey repeatedly to turn the Bode plot data list on or off. After turning on the list, press the **Scroll** soft key and turn the **Universal Knob** to select the frequency point, as shown below.

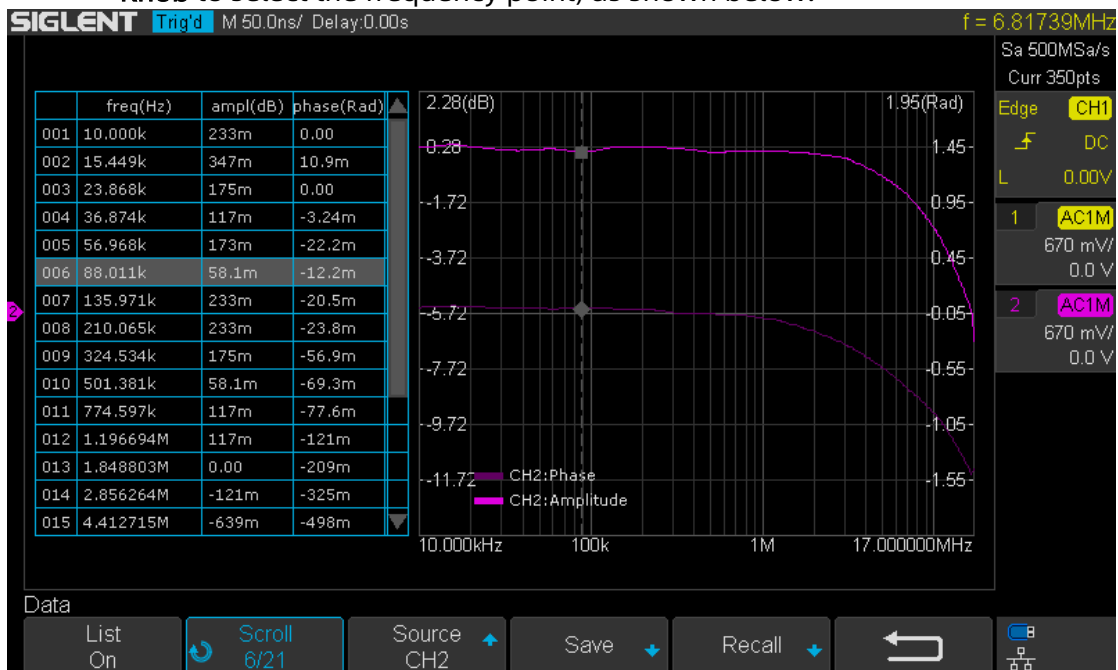

Figure 154 Bode Plot List On

- 2) Press **Save** softkey (**Recall** softkey) to enable the bode plot save (recall) function. See the chapter "Save and Recall" for details.

Example

The following are examples to familiarize you with bode plot.

- Simple Sweep Operation
- Vari-level Sweep Operation

Simple Sweep Operation

1. Press **Utility** button on the front panel to enter the UTILITY function menu, and then press the **Next Page** soft key to enter the second page. Press **Bode Plot II** to enter the BODE PLOT function menu. Press **Config** to enter Configure menu.
2. Press **Source** to enter Source menu to select the waveform generator. In this example, press **Interface** to select “USB”, and then press **Connection Test** to verify setting. Then return to the Configure menu.

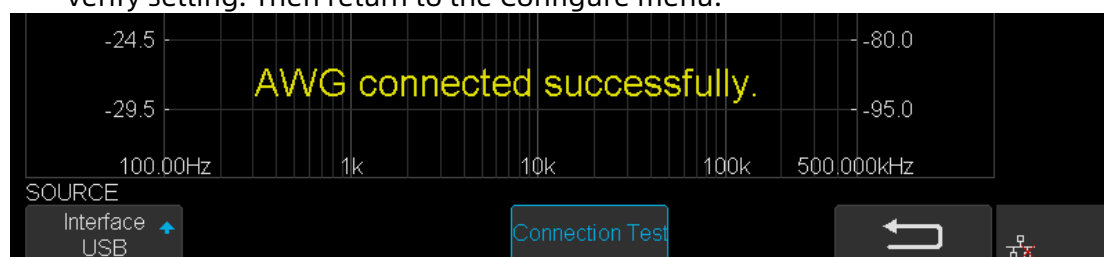

Figure 155 Bode Plot Interface Connection

3. Press **Sweep Mode** to select “Simple” .



Figure 156 Sweep Configure Menu

4. Press **Set Sweep** to enter Set Sweep menu. In this example, press **Mode** to select “Decade” to sweep frequency logarithmically. Press **Start** and use the **Universal Knob** to set the start frequency to 100 Hz. Then set stop frequency to 1 MHz. Press **Points/dec** and use the **Universal Knob** to set the frequency point to 20 points per decade. Then return to the Configure menu.

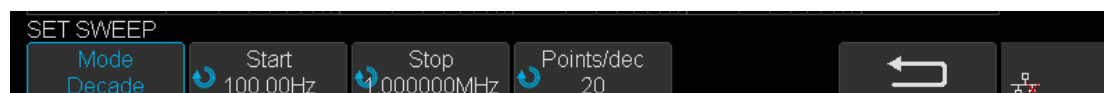

Figure 157 Set Sweep Parameters Menu

5. Press **Set Stimulus** to enter Set Stimulus menu. Press **Amplitude** and use the **Universal Knob** to set the signal amplitude to 2 V. All the other options remain

their default setting. Then return to the Configure menu.



Figure 158 Set Stimulus Menu

- Press **Set Channel** to enter Set Channel menu. In this example, set **DUT Input** to "CH1", and **DUT Output 1** to "CH2". Other DUT Output remains "None". Since we want to maximize measurement dynamic range, set Channel Gain to "Auto". Then return to the Configure menu.

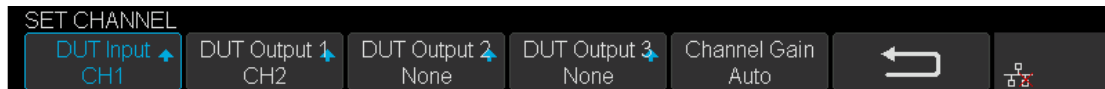

Figure 159 Set Channel Menu

- Configuration was done. Return to root menu and press **Run**, and wait for the sweep to complete.

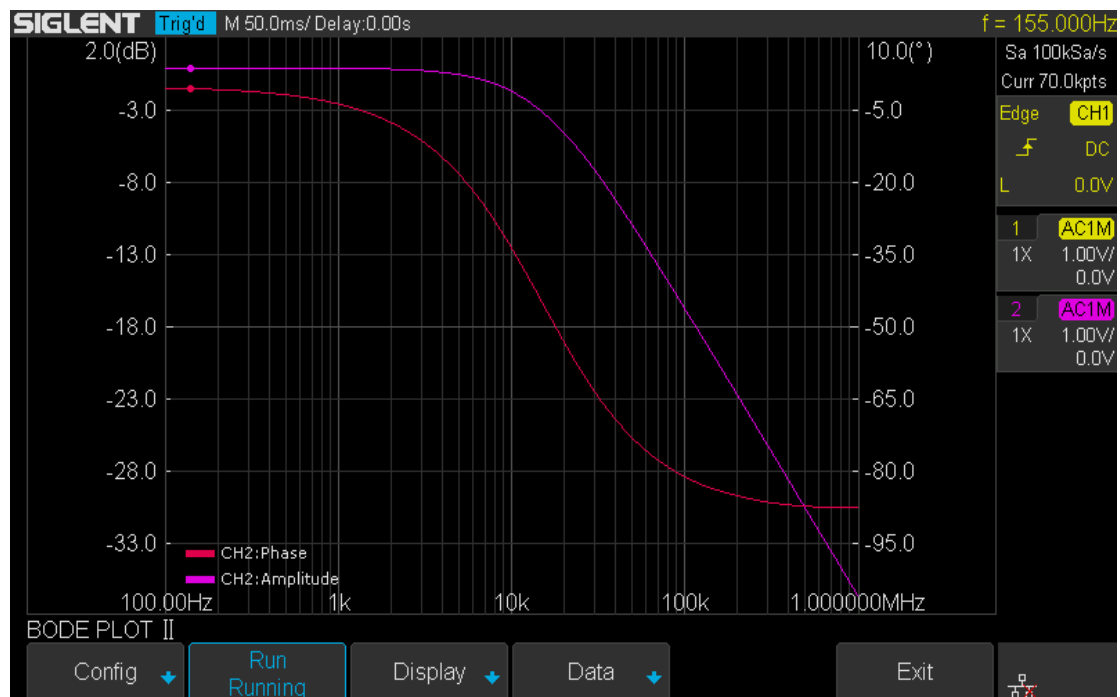

Figure 160 Bode Plot Sweep Curve

Vari-level Sweep Operation

1. Press **Utility** button on the front panel to enter the UTILITY function menu, and then press the **Next Page** soft key to enter the second page. Press **Bode Plot II** to enter the BODE PLOT function menu. Press **Config** to enter Configure menu.
2. Press **Source** to enter Source menu to select the waveform generator. In this example, press **Interface** to select “USB”, and then press **Connection Test** to verify setting. Then return to the Configure menu.

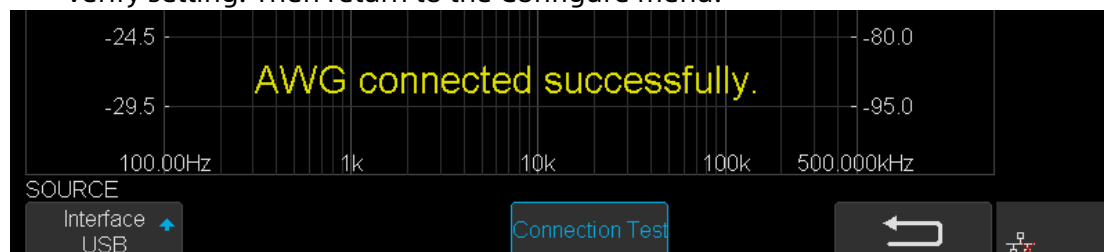

Figure 161 Bode Plot Interface Connection

3. Press **Sweep Mode** to select “Vari-level”.



Figure 162 Vari-level Configure Menu

4. Press **Set Vari-level** to enter Vari-level editor. On the left side of the editor is a spreadsheet which is used to specify the relationship between frequency and amplitude. On the right side is an automatically generated stimulus voltage vs. frequency plot.
5. The operation principle of Vari-level is simple. User specifies a series of joint, which is defined by a given frequency and corresponding amplitude. In between two adjacent joints, the frequency points and their corresponding amplitude are calculated automatically by linear interpolation. The frequency of the joints is sequential, so the frequency of the posterior joint is always higher than the frequency of the anterior joint. And always, the first and the last joint defines the start and stop frequency.
6. Press **Profile** and use the **Universal Knob** to select “Profile A”. As you can see, up to 4 profiles can be saved.
7. In this example, I will demonstrate how to specify a Vari-level profile widely used in testing power supply loop response. The profile is a 4-joint- polyline with large stimulus amplitude in low frequency and small amplitude in high frequency, and gradual amplitude in intermediate frequency.
8. Press **Joints** and use the **Universal Knob** to set the number of joint to 4.
9. Press **Edit Table** to activate the spreadsheet editor. When the spreadsheet editor is activated, press **Edit Table** will cycle the cursor between frequency, amplitude and the entire column. Then use the **Universal Knob** to adjust the frequency, the amplitude, or to select the column to be edited. Press the

Universal Knob will activate the visual keypad for more precise input.

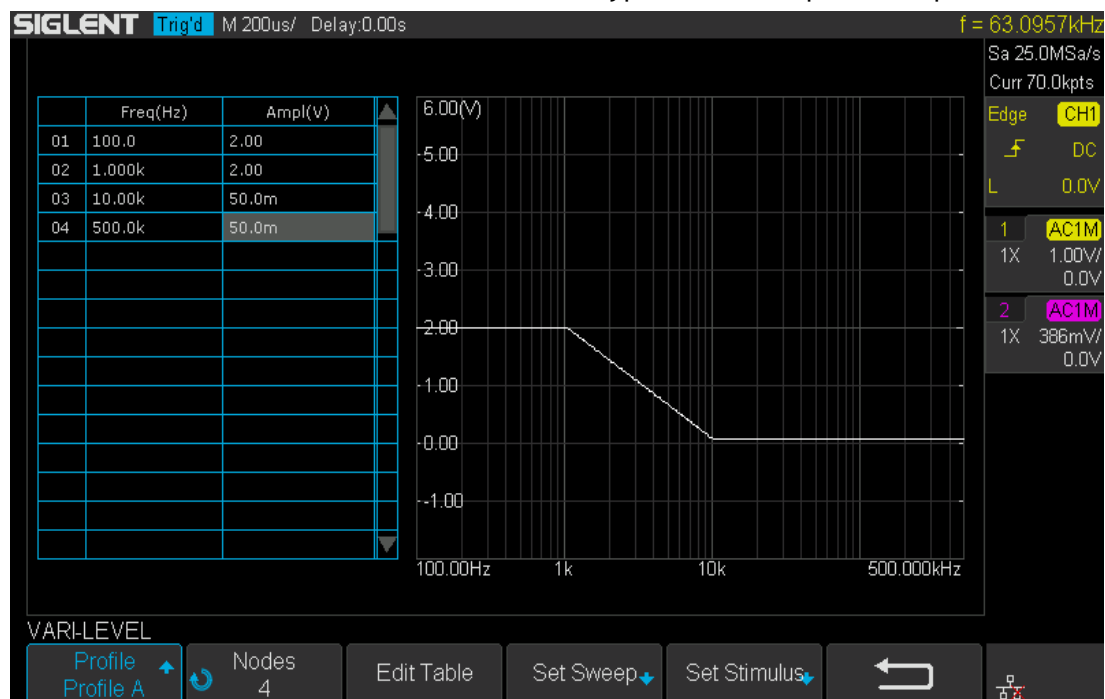

Figure 163 Set Vari-level Parameters Menu

- The **Set Sweep** and **Set Stimulus** in Vari-level editor are similar to that in the Simple sweep mode, but they are independently configured and do not affect each other. These options in Vari-level mode do not have frequency and amplitude input because they are specified in the spreadsheet. Press **Set Sweep** and then set Mode to “Decade”, and set Points/dec to 20. The **Set Stimulus** remains default setting.

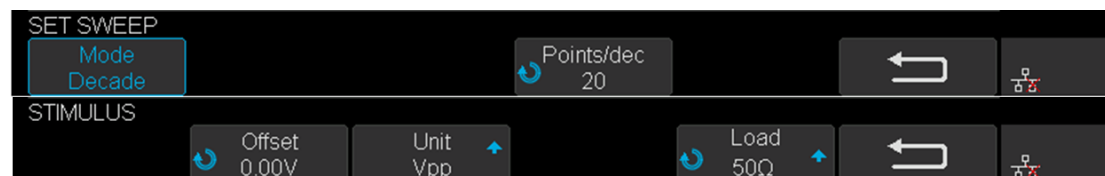

Figure 164 Set Sweep Parameters Menu

- Return to Configure menu and press **Set Channel**. Set **DUT Input** to “CH1” and **DUT Output 1** to “CH2”, and **Channel Gain** to “Auto”.
- Configuration was done. Return to the root menu and press **Run** and wait for the sweep to complete.

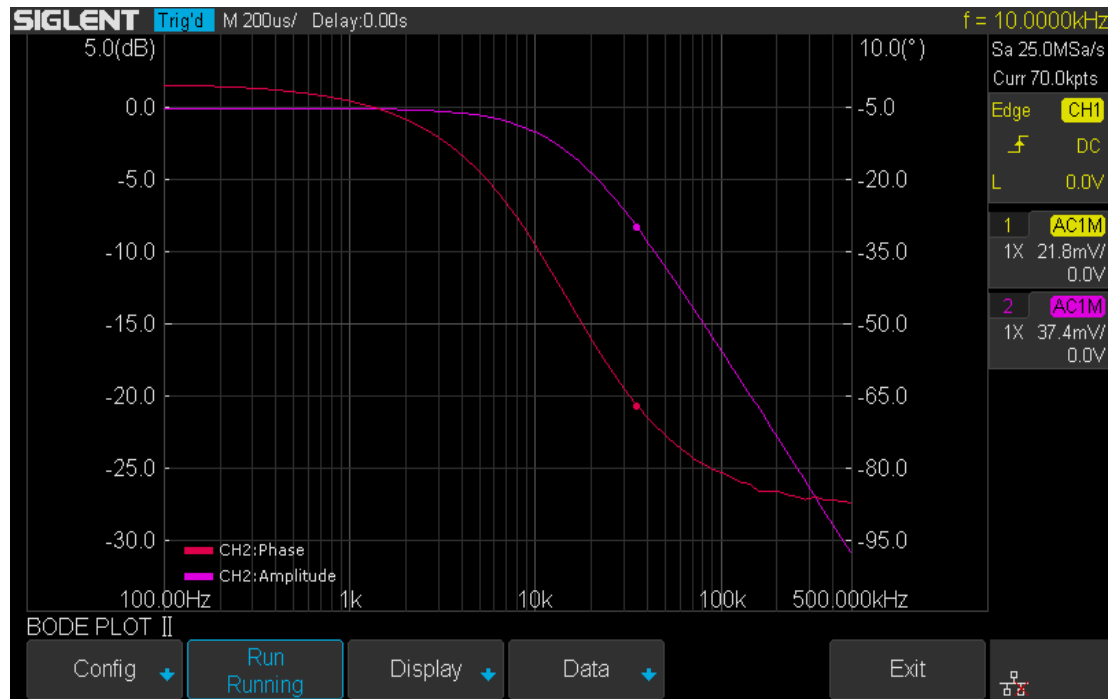

Figure 165 Bode Plot Sweep Curve

Search

SDS1000X-E (4-channel) and SDS1000X-U provide search function. This function can search for the events that users specify in the acquired data, the results are displayed with white triangle symbol. In the YT mode or the Roll mode with the acquisition in stop, the maximum search events number is 700. In the Roll mode with acquisition in run, the maximum search events number is unlimited. The waveform can be zoomed when search function is enabled.

Setting

1. Press the **Search** button on the front panel to enter the SEARCH function menu.
2. Press the **Mode** softkey and then use the **Universal Knob** to select the desired search type. SDS1000X-E and SDS1000X-U provide five search types: Edge, Slope, Pulse, Interval and Runt.



Figure 166 Search Menu

3. Press the **Setting** softkey to enter the SETTING function menu. The setting menu is different according to every search type. The details show as the following table.

Search Mode	Setting Menu Description
Edge	Slope includes Rising, Falling, Either.
Slope	Slope includes Rising, Falling Limit Range includes four types: \leq , \geq , [--,--] and --] [--, Users can select the desired type and then input the time value.
Pulse	Polarity includes Positive and Negative Limit Range includes four types: \leq , \geq , [--,--] and --] [--, Users can select the desired type and then input the time value.
Interval	Slope includes Rising, Falling Limit Range includes four types: \leq , \geq , [--,--] and --] [--, Users can select the desired type and then input the time value.
Runt	Polarity includes Positive and Negative Limit Range includes four types: \leq , \geq , [--,--] and --] [--, Users can select the desired type and then input the time value

4. Press the **Copy Setting** softkey to enter COPY function menu.
 - **Copy from Trig**: copy the trigger setup for the selected search type to the search setup.
 - **Copy to Trig**: copy the setup for the selected search type to the same trigger type.
 - **Cancel Copy**: undo a copy.
5. Press the **Thresholds** softkey to enter THRESHOLDS function menu, then, to set channel search thresholds.

Results

When the acquisition is started, "EVENT NUM: 7" means total events number.

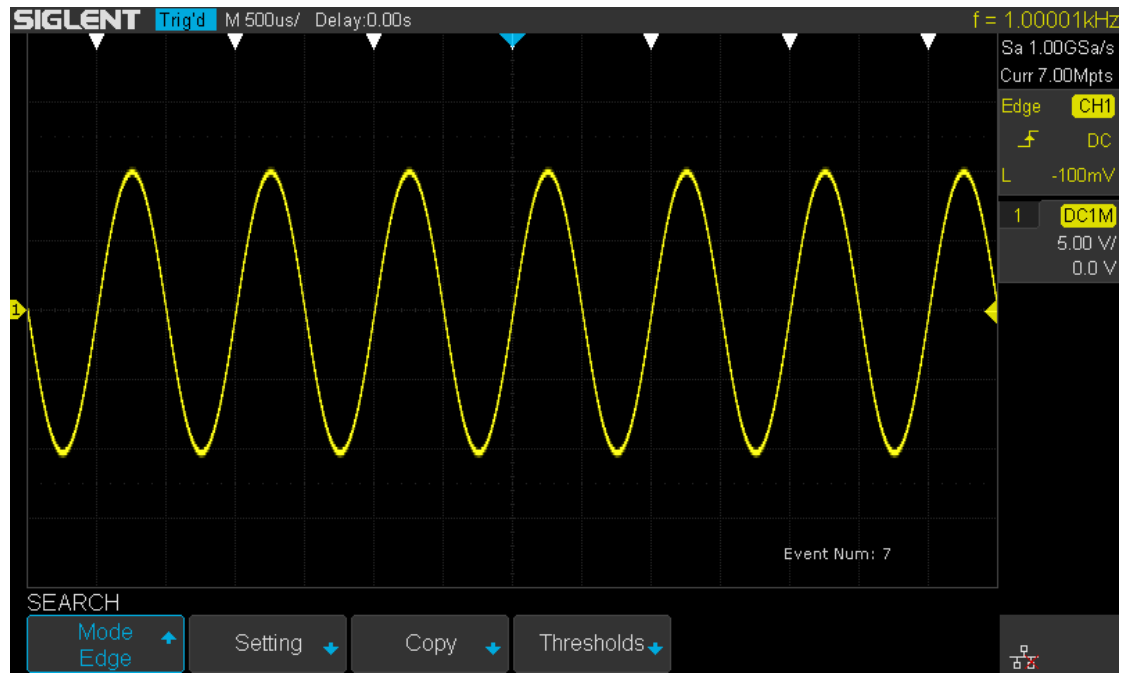

Figure 167 Search in Run

When the acquisition is stop, “EVENT NUM: 4/7” means current event number/total events number, the current event is the closest event to the middle of the screen.

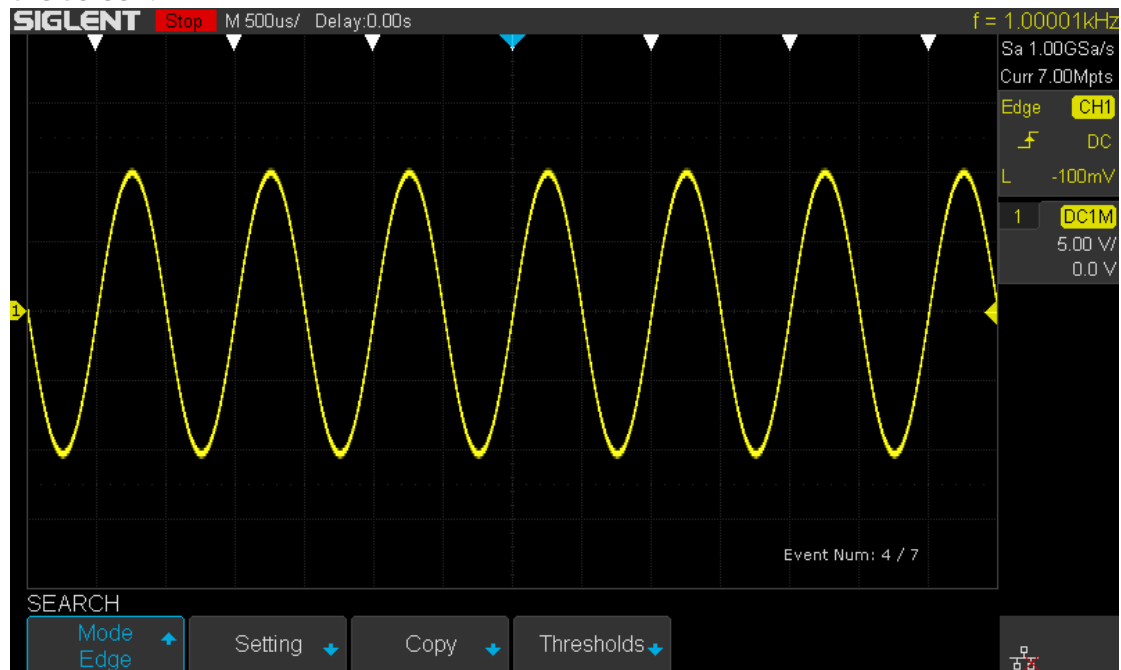

Figure 168 Search in Stop

Navigate

SDS1000X-E(4-channel) and SDS1000X-U provide three navigate type: Search Event, Time, History Frame.

Time Navigate

1. Press the **Navigate** on the front panel to enter the NAVIGATE function menu.
2. Press the **Type** softkey In the NAVIGATE function menu, then select **Time**.
3. There are two ways to navigate time.
 - a. Press the **Time** softkey, then, turn the **Universal Knob** to select the desired value or press the **Universal Knob** then enter the value by the pop keyboard.
 - b. Press the **navigation** keys ◀▶ on the front panel to play backward, stop, or play forward in time. You can press the ◀ or ▶ keys multiple times to speed up the playback. There are three speed levels: Low Speed, Medium Speed, and High Speed.

History Frame Navigate

When the History function is enabled, you can use the navigation controls to play through the acquired frames.

1. Press the **Navigate** on the front panel to enter the NAVIGATE function menu.
2. Press the **Type** softkey in the Navigate Menu, then select **History Frame**.
3. Press the **Frame Num** softkey, then there are two ways to navigate history frames.
 - a. Turn the **Universal Knob** to select the desired number or press the **Universal Knob** then enter the number by the pop keyboard.
 - b. Press the navigation keys ◀▶ on the front panel to play backward, stop, or play forward.

Search Event Navigate

When the Search function is enabled and acquisitions are stopped, you can use the navigation controls to go to found search events

1. Press the **Navigate** on the front panel to enter the NAVIGATE function menu.
2. Press the **Type** softkey in the NAVIGATE function menu, then select **Search Event**.
3. There are two ways to navigate search events.
 - a. Press the **Event Num** softkey, then, turn the **Universal Knob** to select the desired value or press the **Universal Knob** then enter the value by the pop keyboard.
 - b. Press the **Navigate** keys ◀ ▶ on the front panel to go to the previous or next search event.

History

The history function can record the waveforms of the input channels before press the **Run/Stop** button. In run state, the oscilloscope records input waveform continually; when fill up the memory (reach the maximal frame), the new frames will cover the old frames and keep the latest frames.

To use the History function, the HORIZONTAL **Format** must be set to **YT**.

Do the following steps to record and replay waveform:

- Press the **History** button on the front panel to enable the History function.
 - When in run state, the waveform will enter the stop state.
 - When in stop state, and then enable the History function, the oscilloscope will keep the stop state.
 - Press the **History** button again or press the **Stop** button to turn off History function.
- Press the **List** softkey to turn on or off the list display. The list records the timestamp of every frame. It is accurate to microseconds.

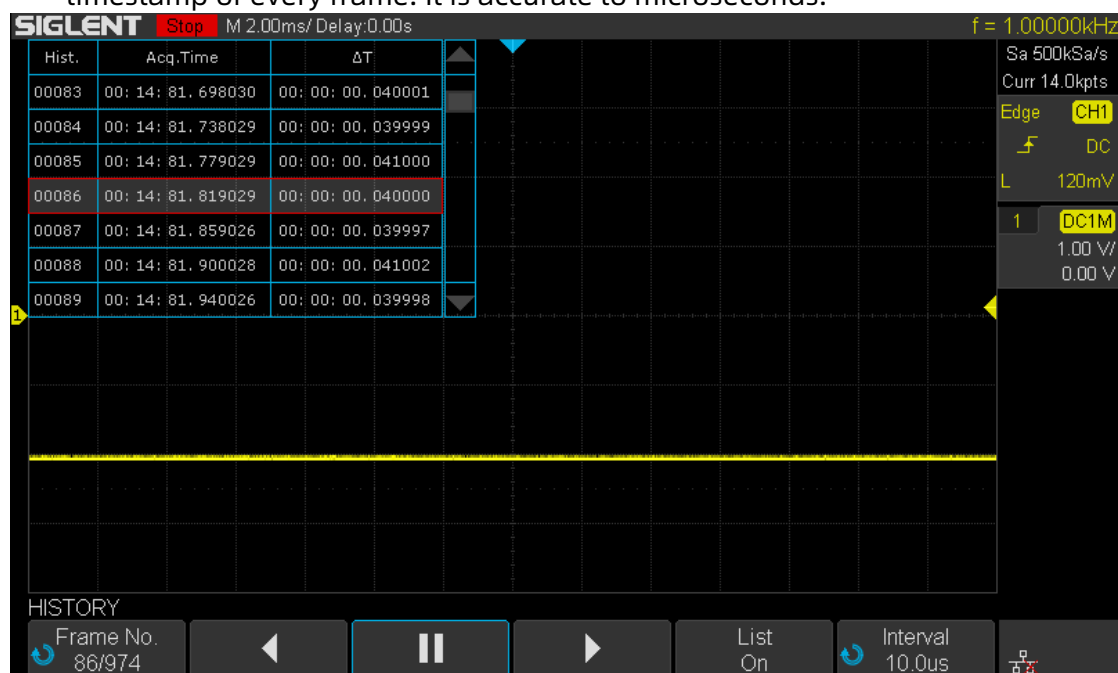





Figure 169 History

- Press the **Frame No.** softkey; then turn the **Universal Knob** to select the frame to display.
 - The format of the **Frame** is A/B; A is the frames number that displaying on the screen and B is the maximal frame number you can set.
 - The maximal frame number is determined by the current sampling point

(Curr value) and sampling rate.

- When press the **Run/Stop** button or enable the history function, you may not get the maximal frames, because the memory is not filled. So if you want to get the maximal frames, please wait for enough time for acquisition.
4. Press the  softkey to replay the waveform from the current frame to 1.
 5. Press the  softkey to stop replay.
 6. Press the  softkey to replay the waveform from the current frame to the last frame.

Factory Setup

Press **Save/Recall** function key, then press **Save** menu select **To Default Key** set the type to **Factory Setup**. Then press the **Default** button on the front to set the oscilloscope to the leave factory setup. Another way is press **Save/Recall** function key, then press **Recall** menu select **Factory Default** to recall.

Troubleshooting

The commonly encountered failures and their solutions are listed below. When you encounter those problems, please solve them following the corresponding steps. If the problem remains still, please contact **SIGLENT** Company as soon as possible.

1. **The screen is still dark (no display) after power on:**
 - 1) Check whether the power is correctly connected.
 - 2) Check whether the power switch is really on.
 - 3) Check whether the fuse is burned out. If the fuse needs to be changed, please use the specified fuse.
 - 4) Restart the instrument after finishing the above inspections.
 - 5) If it still does not work correctly, please contact **SIGLENT**.

2. **The signal is sampled but no waveform of the signal is displayed:**
 - 1) Check whether the probe is correctly connected to the signal connecting wire.
 - 2) Check whether the signal connecting wire is correctly connected to the BNC (namely channel connector).
 - 3) Check whether the probe is correctly connected to the item to be tested.
 - 4) Check whether there are signals generated from the item to be tested (you can connect the probe compensation signal to the problematic channel to determine which has problem, the channel or the item to be tested).
 - 5) Resample the signal.

3. **The tested voltage amplitude is greater or lower than the actual value (note that this problem usually occurs when probe is used):**

Check whether the attenuation coefficient of the channel complies with the attenuation ratio of the probe.

4. **There is waveform display but not stable:**
 - 1) Check the trigger signal source: check whether the **Source** item at the trigger panel complies with the signal channel actually used.
 - 2) Check the trigger type: general signals should use “Edge” trigger and video signal should use “Video” trigger. Only when the proper trigger type is used, can the waveform be displayed stably.
 - 3) Change the trigger holdoff setting.

5. **No display after pressing Run/Stop:**

Check whether the mode at the trigger panel (TRIGGER) is on “Normal” or

“Single” and whether the trigger level exceeds the waveform range. If yes, set the trigger level to the middle or set the mode to “Auto” .

Note: using **AUTO** could automatically finish the above setting.

6. The display of waveform is ladder-like:

- 1) The horizontal time base might be too low. Increase the horizontal time base to increase the horizontal resolution and improve the display.
- 2) If the display **Type** is “Vectors” , the lines between the sample points may cause ladder-like display. Set **Type** to “Dots” to solve the problem.

7. Fail to connect PC through USB:

Check the **IO Setting** in **Utility** to make sure whether the setting in **USB Device** matches the device currently connected. If needed, restart the oscilloscope.

8. The USB storage device cannot be recognized:

- 1) Check whether the USB storage device can work normally.
- 2) Make sure whether the USB interface can work normally.
- 3) Make sure that the USB storage device being used is flash storage type. This oscilloscope does not support hardware storage type.
- 4) Restart the instrument and then insert the USB storage device to check it.
- 5) If the USB storage device still cannot be used normally, please contact **SIGLENT**.

SDS1000X-E

SDS1000X-U

Digital Oscilloscope

About SIGLENT

SIGLENT is an international high-tech company, concentrating on R&D, sales, production and services of electronic test & measurement instruments.

SIGLENT first began developing digital oscilloscopes independently in 2002. After more than a decade of continuous development, SIGLENT has extended its product line to include digital oscilloscopes, function/arbitrary waveform generators, RF generators, digital multimeters, DC power supplies, spectrum analyzers, vector network analyzers, isolated handheld oscilloscopes, electronic load and other general purpose test instrumentation. Since its first oscilloscope, the ADS7000 series, was launched in 2005, SIGLENT has become the fastest growing manufacturer of digital oscilloscopes. We firmly believe that today SIGLENT is the best value in electronic test & measurement.

Headquarters:

SIGLENT Technologies Co., Ltd
Add: Bldg No.4 & No.5, Antongda Industrial Zone, 3rd Liuxian Road, Bao'an District, Shenzhen, 518101, China
Tel: + 86 755 3688 7876
Fax: + 86 755 3359 1582
Email: sales@siglent.com
Website: int.siglent.com

USA:

SIGLENT Technologies America, Inc
6557 Cochran Rd Solon, Ohio 44139
Tel: 440-398-5800
Toll Free: 877-515-5551
Fax: 440-399-1211
Email: info@siglent.com
Website: www.siglentna.com

Europe:

SIGLENT Technologies Germany GmbH
Add: Staetzlinger Str. 70
86165 Augsburg, Germany
Tel: +49(0)-821-666 0 111 0
Fax: +49(0)-821-666 0 111 22
Email: info-eu@siglent.com
Website: www.siglenteu.com

Follow us on
Facebook: SiglentTech

